

# SKN 240, SKR 240

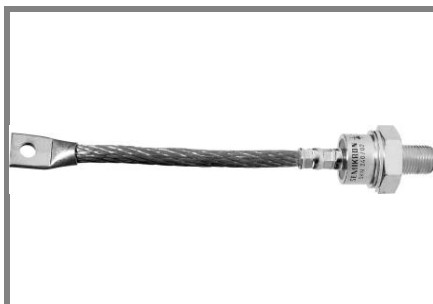

## Stud Diode

## Rectifier Diode

**SKN 240**

**SKR 240**

### Features

- Reverse voltages up to 1800 V
- Hermetic metal case with glass insulator
- Threaded stud ISO M16 x 1,5
- SKN / SKR 240/04 ... /16 also available with threaded stud 3/4 - 16 UNF (e.g. SKR 240/12 UNF)
- SKN: anode to stud, SKR: cathode to stud

### Typical Applications

- All-purpose mean power rectifier diodes
- Cooling via heatsinks
- Non-controllable and half-controllable rectifiers
- Free-wheeling diodes
- Recommended snubber network:  
RC: 0,5  $\mu$ F, 30  $\Omega$  ( $P_R = 2W$ ),  
 $R_P = 50$  k $\Omega$  ( $P_R = 20$  W)

$V_{RSM}$ V	$V_{RRM}$ V	$I_{FRMS} = 500$ A (maximum value for continuous operation) $I_{FAV} = 240$ A (sin. 180; $T_c = 125$ °C)	
400	400	SKN 240/04	SKR 240/04
800	800	SKN 240/08	SKR 240/08
1200	1200	SKN 240/12	SKR 240/12
1400	1400	SKN 240/14	SKR 240/14
1600	1600	SKN 240/16	SKR 240/16
1800	1800	SKN 240/18	SKR 240/18

Symbol	Conditions	Values	Units
$I_{FAV}$	sin. 180; $T_c = 100$ °C	320	A
$I_D$	K 0,55; $T_a = 45$ °C; B2 / B6	340 / 480	A
	K 0,55F; $T_a = 35$ °C; B2 / B6	620 / 840	A
$I_{FSM}$	$T_{vj} = 25$ °C; 10 ms	6000	A
	$T_{vj} = 180$ °C; 10 ms	5000	A
$i^2t$	$T_{vj} = 25$ °C; 8,3 ... 10 ms	180000	A <sup>2</sup> s
	$T_{vj} = 180$ °C; 8,3 ... 10 ms	125000	A <sup>2</sup> s
$V_F$	$T_{vj} = 25$ °C; $I_F = 750$ A	max. 1,4	V
$V_{(TO)}$	$T_{vj} = 180$ °C	max. 0,85	V
$r_T$	$T_{vj} = 180$ °C	max. 0,6	m $\Omega$
$I_{RD}$	$T_{vj} = 180$ °C; $V_{RD} = V_{RRM}$	max. 60	mA
$Q_{tr}$	$T_{vj} = 160$ °C; $-di_F/dt = 10$ A/ $\mu$ s	200	$\mu$ C
$R_{th(j-c)}$		0,2	K/W
$R_{th(c-s)}$		0,03	K/W
$T_{vj}$		- 40 ... + 180	°C
$T_{stg}$		- 55 ... + 180	°C
$V_{isol}$		-	V~
$M_s$	to heatsink	30	Nm
a		5 * 9,81	m/s <sup>2</sup>
m	approx.	250	g
Case		E 15	

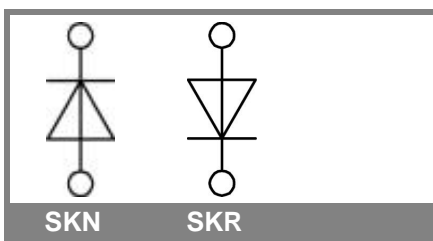

# SKN 240, SKR 240

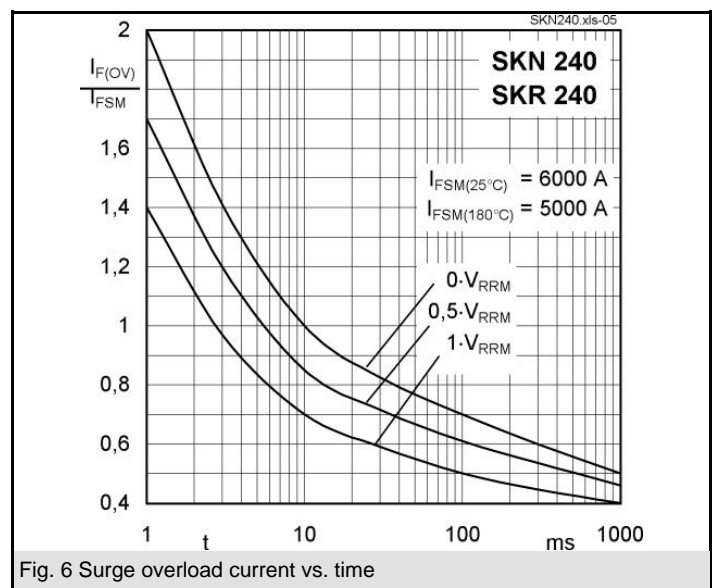
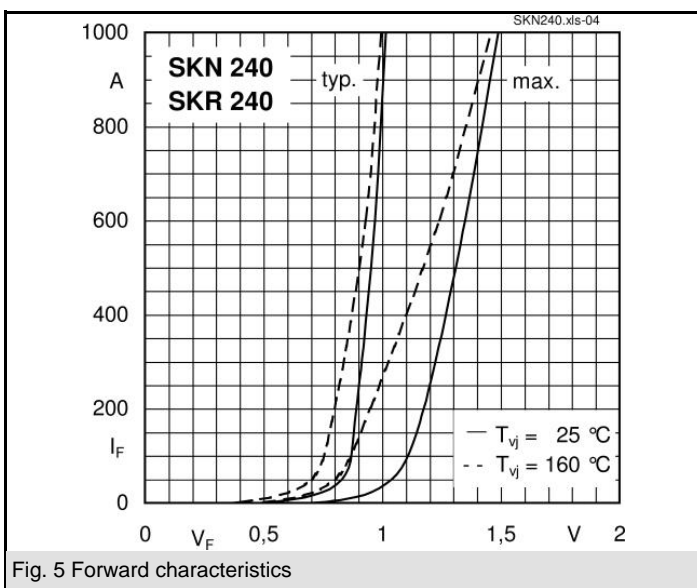
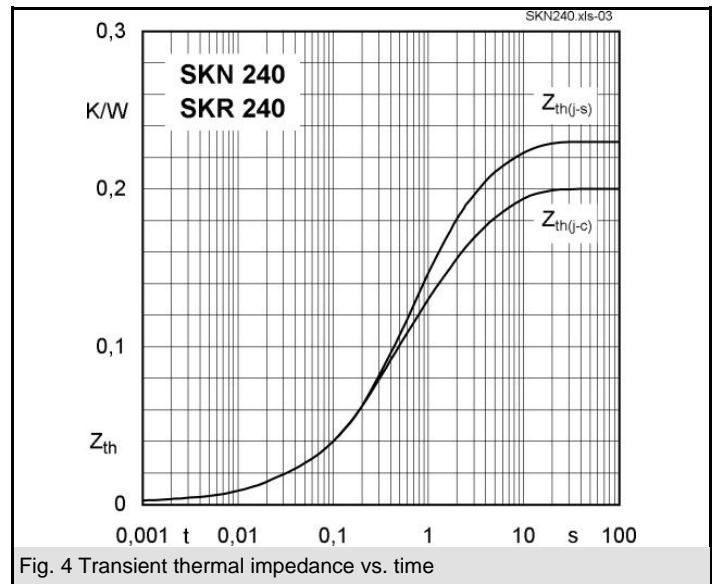
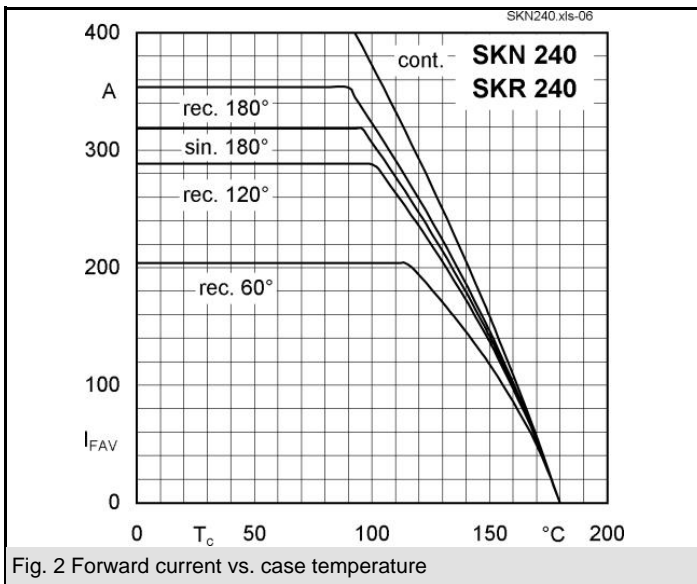
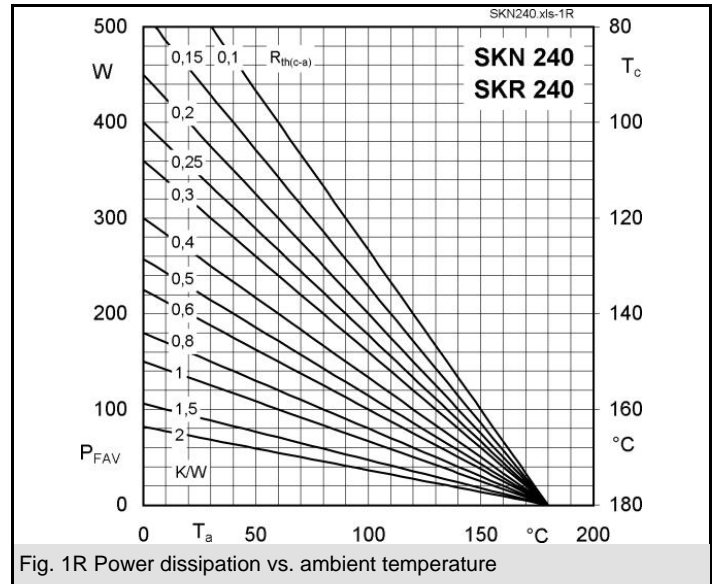
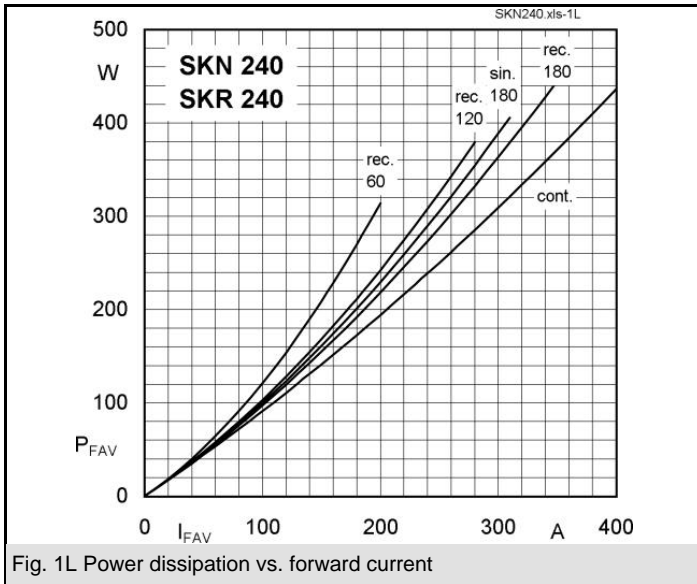

# SKN 240, SKR 240

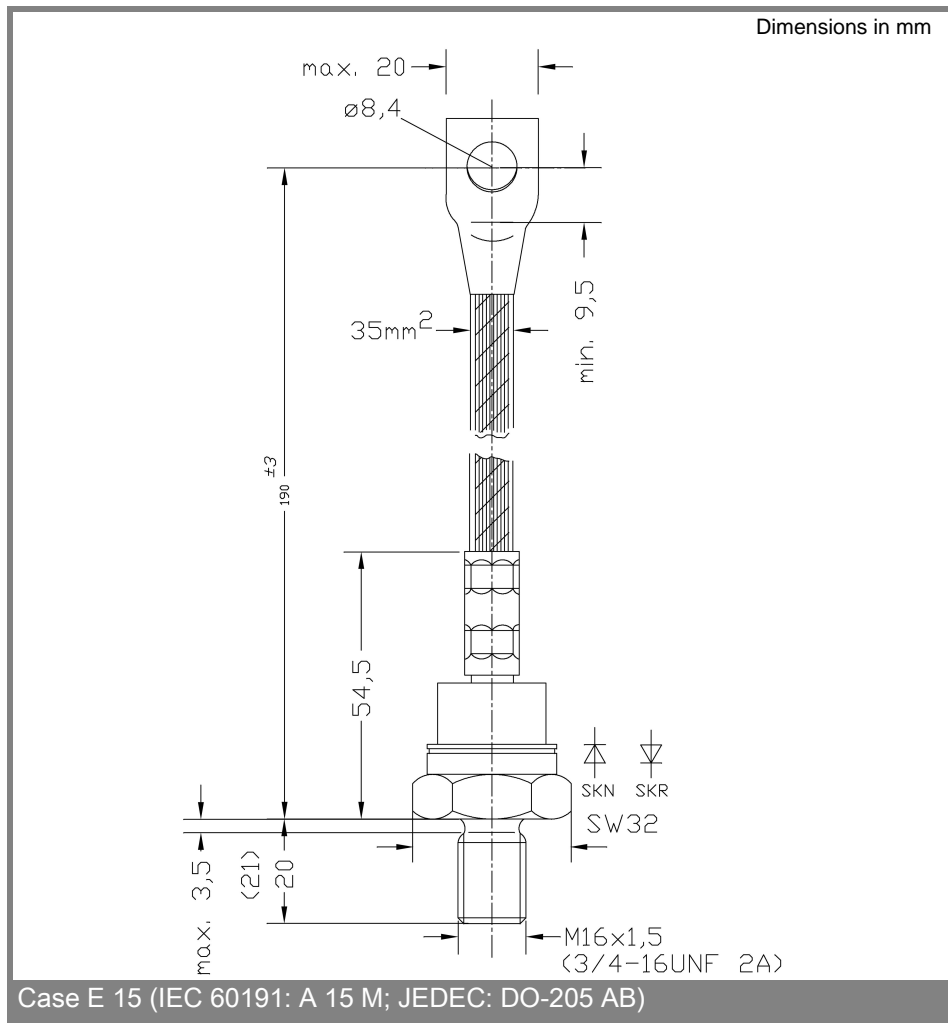

This technical information specifies semiconductor devices but promises no characteristics. No warranty or guarantee expressed or implied is made regarding delivery, performance or suitability.