

OLED DISPLAY MODULE

Product Specification

CUSTOMER	Standard	
PRODUCT NUMBER	DD-12864GE-6K	
CUSTOMER APPROVAL		Date

INTERNAL APPROVALS		
Product Mgr	Doc. Control	Electr. Eng
Bazile Peter	Bazile Peter	Chen Szu Wei
Date: 18 Apr 14	Date: 18 Apr 14	Date: 18 Apr 14

TABLE OF CONTENTS

1	MAIN FEATURES	4
2	MECHANICAL SPECIFICATION	5
2.1	MECHANICAL CHARACTERISTICS	5
2.2	MECHANICAL DRAWING	6
3	ELECTRICAL SPECIFICATION.....	7
3.1	ABSOLUTE MAXIMUM RATINGS	7
3.2	ELECTRICAL CHARACTERISTICS	8
3.3	INTERFACE PIN ASSIGNMENT	9
3.4	BLOCK DIAGRAM	12
3.5	TIMING CHARACTERISTICS	13
4	OPTICAL SPECIFICATION.....	17
4.1	OPTICAL CHARACTERISTICS.....	17
5	FUNCTIONAL SPECIFICATION	18
5.1	COMMANDS	18
5.2	POWER UP/DOWN SEQUENCE.....	18
5.3	RESET CIRCUIT	19
5.4	ACTUAL APPLICATION EXAMPLE.....	20
6	PACKAGING AND LABELLING SPECIFICATION.....	22
6.1	LABELLING & MARKING.....	22
7	QUALITY ASSURANCE SPECIFICATION.....	23
7.1	CONFORMITY	23
7.2	DELIVERY ASSURANCE	23
7.3	DEALING WITH CUSTOMER COMPLAINTS	29
8	RELIABILITY SPECIFICATION	30
8.1	RELIABILITY TESTS	30
8.2	LIFE TIME.....	30
8.3	FAILURE CHECK STANDARD	30
9	HANDLING PRECAUTIONS.....	31
9.1	HANDLING PRECAUTIONS	31
9.2	STORAGE PRECAUTIONS	32
9.3	DESIGNING PRECAUTIONS.....	32
9.4	OTHER PRECAUTIONS	33
9.5	PRECAUTIONS WHEN DISPOSING OF THE OEL DISPLAY MODULES	33
10	SUPPORTED ACCESSORIES	34
10.1	DUO KIT.....	34
10.2	TRANSITION BOARD CARD	34
10.3	CONNECTOR BOARD CARD.....	34
10.4	CONNECTOR	34

Product No.	DD-12864GE-6K	REV. B

Page	2 / 34
------	--------

REVISION RECORD

Rev.	Date	Page	Chapt.	Comment	ECR no.
A	18 Apr 14			First Issue	

Product No.	DD-12864GE-6K	REV. B

Page	3 / 34
------	--------

1 MAIN FEATURES

ITEM	CONTENTS
Display Format	128 x 64 Dots
Overall Dimensions	60.50 x 37.00 x 2.00 mm
Colour	Monochrome Green
Active Area	55.01 x 27.49 mm
Viewing Area	57.01 x 29.49 mm
Display Mode	Passive Matrix (2.42")
Driving Method	1/64 duty
Driver IC	SSD1309
Operating temperature	-40 ~ +70
Storage temperature	-40 ~ +85

Product No.	DD-12864GE-6K	REV. B

Page	4 / 34
------	--------

2 MECHANICAL SPECIFICATION

2.1 MECHANICAL CHARACTERISTICS

ITEM	CHARACTERISTIC	UNIT
Display Format	128 x 64 Dots	Dots
Overall Dimensions	60.50 x 37.00 x 2.00	mm
Viewing Area	57.01 x 29.49	mm
Active Area	55.01 x 27.49	mm
Dot Size	0.40 x 0.40	mm
Dot Pitch	0.43 x 0.43	mm
Weight	8.60	g
IC Controller/Driver	SSD1309	

Product No.	DD-12864GE-6K	REV. B

Page	5 / 34
------	--------

2.2 MECHANICAL DRAWING

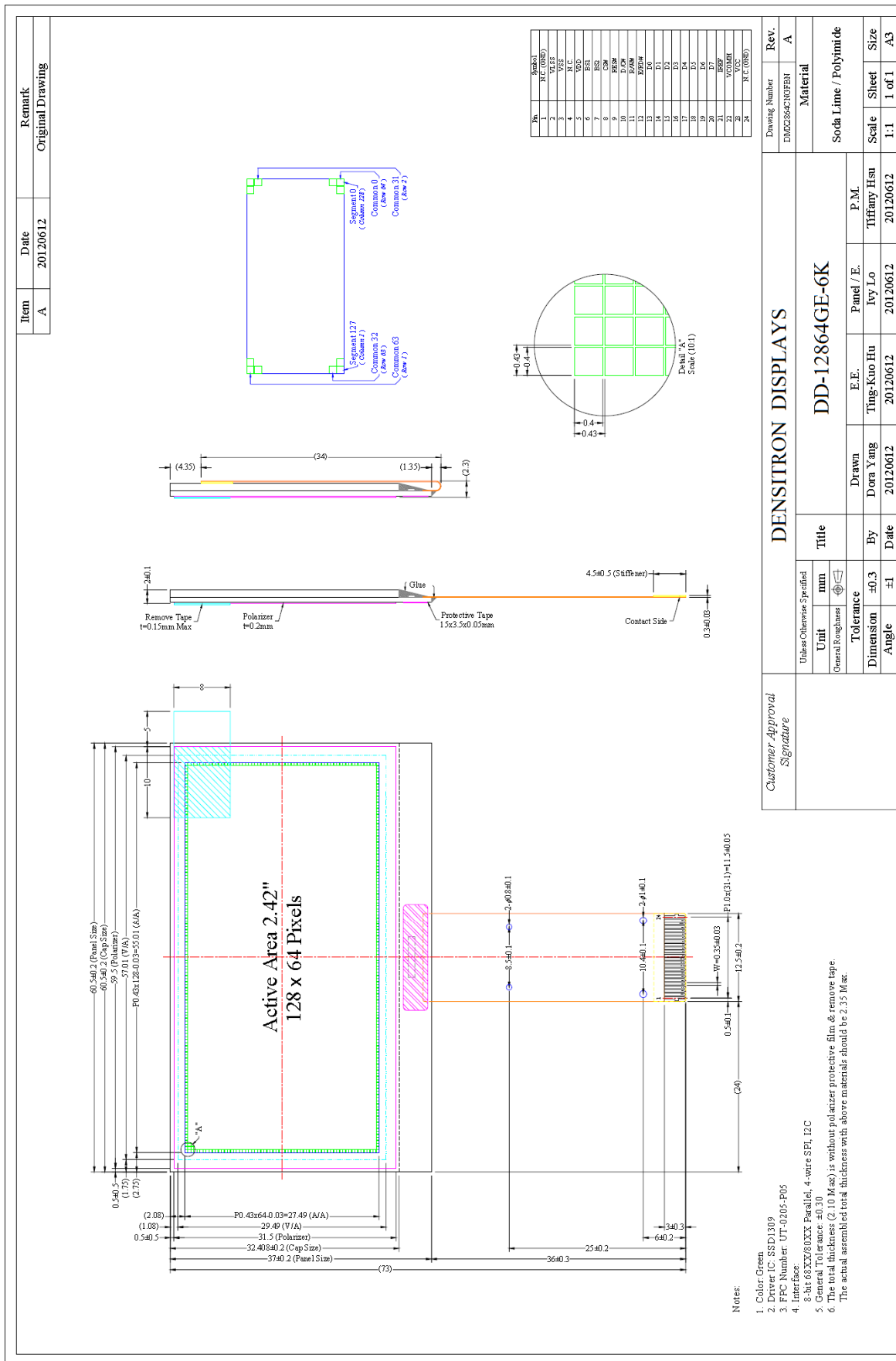

Product No.	DD-12864GE-6K	REV. B
-------------	---------------	--------

Page	6 / 34
------	--------

3 ELECTRICAL SPECIFICATION

3.1 ABSOLUTE MAXIMUM RATINGS

VSS = 0 V, Ta = 25 °C

Item	Symbol	Min	Max	Unit	Note
Supply Voltage for logic	V _{DD}	-0.3	4.0	V	Note 1, 2
Supply voltage for Display	V _{CC}	0	15	V	
Operating Temperature	Top	-40	70	°C	Note 3
Storage Temperature	Tst	-40	85	°C	Note 3
Life Time (120 cd/m ²)		20,000	-	hour	Note 4
Life Time (80 cd/m ²)		40,000	-	hour	Note 4

Note 1: All the above voltages are on the basis of “VSS=0V”.

Note 2: When this module is used beyond the above absolute maximum ratings, permanent damage to the module may occur. Also for normal operations it’s desirable to use this module under the conditions according to Section 3.2 “Electrical Characteristics”. If this module is used beyond these conditions the module may malfunction and the reliability could deteriorate.

Note 3: The defined temperature ranges do not include the polarizer. The maximum withstood temperature of the polarizer should be 80°C.

Note 4: VCC = 13.0V, Ta = 25°C, 50% Checkerboard.

Software configuration follows Section 5.4 Initialization. End of lifetime is specified as 50% of initial brightness reached. The average operating lifetime at room temperature is estimated by the accelerated operation at high temperature conditions.

3.2 ELECTRICAL CHARACTERISTICS

Characteristics	Symbol	Conditions	Min	Typ	Max	Unit
Supply Voltage for Logic	V _{DD}		1.65	2.8	3.3	V
Supply Voltage for Display	V _{CC}	Note 1	12.5	13.0	13.5	V
High Level Input	V _{IH}	I _{OUT} =0.1mA, 3.3MHz	0.8xV _{DD}	-	V _{DD}	V
Low Level Input	V _{IL}		0	-	0.2 x V _{DD}	V
High Level Output	V _{OH}		0.9 x V _{DD}	-	V _{DD}	V
Low Level Output	V _{OL}		0	-	0.1 x V _{DD}	V
Operating current for V _{DD}	I _{DD}		-	180	300	μA
Operating current for V _{CC}	I _{CC}	Note 2	-	15.3	19.1	mA
		Note 3	-	21.2	26.5	
		Note 4	-	31.7	39.6	
Sleep mode current for V _{DD}	I _{DD SLEEP}		-	1	5	μA
Sleep mode current for V _{CC}	I _{CC SLEEP}		-	2	10	μA

Note 1: Brightness (Lbr) and Supply Voltage for Display (V_{CC}), are subject to the change of the panel characteristics and the customer's request.

Note 2: V_{DD} = 2.8V, V_{CC} = 13.0V, 30% display area turned on.

Note 3: V_{DD} = 2.8V, V_{CC} = 13.0V, 50% display area turned on.

Note 4: V_{DD} = 2.8V, V_{CC} = 13.0V, 100% display area turned on.

Product No.	DD-12864GE-6K	REV. B

Page	8 / 34
------	--------

3.3 INTERFACE PIN ASSIGNMENT

No.	Symbol	I/O	Function															
1	N.C. (GND)	-	Reserved Pin (Supporting Pin) The supporting pin can reduce the influences from stresses on the function pins. This pin must be connected to external ground as the ESD protection circuit.															
2	VLSS	P	Ground of Analogue Circuit This is an analogue ground pin. It should be connected to VSS externally.															
3	VSS	P	Ground of Logic Circuit This is a ground pin. It acts as a reference for the logic pins. It must be connected to external ground.															
4	N.C	-	Reserved Pin The N.C. pins between function pins are reserved for compatible and flexible design.															
5	VDD	P	Power Supply for Logic Circuit This is a voltage supply pin. It must be connected to external source															
6	BS1	I	Communicating Protocol Select These pins are MCU interface selection input. See the following table: <table border="1" style="margin-left: 20px;"> <thead> <tr> <th></th> <th>BS1</th> <th>BS2</th> </tr> </thead> <tbody> <tr> <td>I2C</td> <td>1</td> <td>0</td> </tr> <tr> <td>4-wire SPI</td> <td>0</td> <td>0</td> </tr> <tr> <td>68XX-parallel</td> <td>0</td> <td>1</td> </tr> <tr> <td>80XX-parallel</td> <td>1</td> <td>1</td> </tr> </tbody> </table>		BS1	BS2	I2C	1	0	4-wire SPI	0	0	68XX-parallel	0	1	80XX-parallel	1	1
	BS1			BS2														
I2C	1			0														
4-wire SPI	0			0														
68XX-parallel	0	1																
80XX-parallel	1	1																
7	BS2																	
8	CS#	I	Chip Select This pin is the chip select input. The chip is enabled for MCU communication only when CS# is pulled low.															
9	RES#	I	Power Reset for Controller and Driver This pin is reset signal input. When the pin is low, initialization of the chip is executed. Keep this pin pull high during normal operation															

Product No.	DD-12864GE-6K	REV. B

Page	9 / 34
------	--------

10	D/C#	I	<p>Data/Command Control</p> <p>This pin is Data/Command control pin. When the pin is pulled high, the input at D7~D0 is treated as display data. When the pin is pulled low, the input at D7~D0 will be transferred to the command register.</p> <p>When the pin is pulled high and serial interface mode is selected, the data at SDIN is treated as data. When it is pulled low, the data at SDIN will be transferred to the command register. In I2C mode, this pin acts as SA0 for slave address selection.</p> <p>For detail relationship to MCU interface signals, please refer to the Timing Characteristics Diagrams.</p>
11	R/W#	I	<p>Read/Write Select or Write</p> <p>This pin is MCU interface input. When interfacing to a 68XX-series microprocessor, this pin will be used as Read/Write (R/W#) selection input. Pull this pin to “High” for read mode and pull it to “Low” for write mode.</p> <p>When 80XX interface mode is selected, this pin will be the Write (WR#) input. Data write operation is initiated when this pin is pulled low and the CS# is pulled low. When serial or I2C mode is selected, this pin must be connected to VSS</p>
12	E/RD#	I	<p>Read/Write Enable or Read</p> <p>This pin is MCU interface input. When interfacing to a 68XX-series microprocessor, this pin will be used as the Enable (E) signal. Read/write operation is initiated when this pin is pulled high and the CS# is pulled low. When connecting to an 80XX-microprocessor, this pin receives the Read (RD#) signal. Data read operation is initiated when this pin is pulled low and CS# is pulled low. When serial or I2C mode is selected, this pin must be connected to VSS</p>
13~20	D0~D7	I/O	<p>Host Data Input/output Bus</p> <p>These pins are 8-bit bi-directional data bus to be connected to the microprocessor’s data bus. When serial mode is selected, D1 will be the serial data input SDIN and D0 will be the serial clock input SCLK.</p> <p>When I2C mode is selected, D2 & D1 should be tied together and serve as SDAout & SDAin in application and D0 is the serial clock input SCL.</p> <p>Unused pins must be connected to VSS except for D2 in serial mode</p>
21	IREF	I	<p>Current Reference for Brightness Adjustment</p> <p>This pin is segment current reference pin. A resistor should be connected between this pin and VSS. Set the current lower than 10μA maximum..</p>

Product No.	DD-12864GE-6K	REV. B

Page	10 / 34
------	---------

22	VCOMH	O	<p>Voltage Output High Level for COM Signal</p> <p>This pin is the input pin for the voltage output high level for COM signals. A capacitor should be connected between this pin and VSS.</p>
23	VCC	P	<p>Power Supply for OEL Panel</p> <p>This is the most positive voltage supply pin of the chip. It must be supplied externally.</p>
24	N.C. (GND)	-	<p>Reserved Pin (Supporting Pin)</p> <p>The supporting pin can reduce the influences from stresses on the function pins. This pin must be connected to external ground as the ESD protection circuit.</p>

Product No.	DD-12864GE-6K	REV. B

Page	11 / 34
------	---------

3.4 BLOCK DIAGRAM

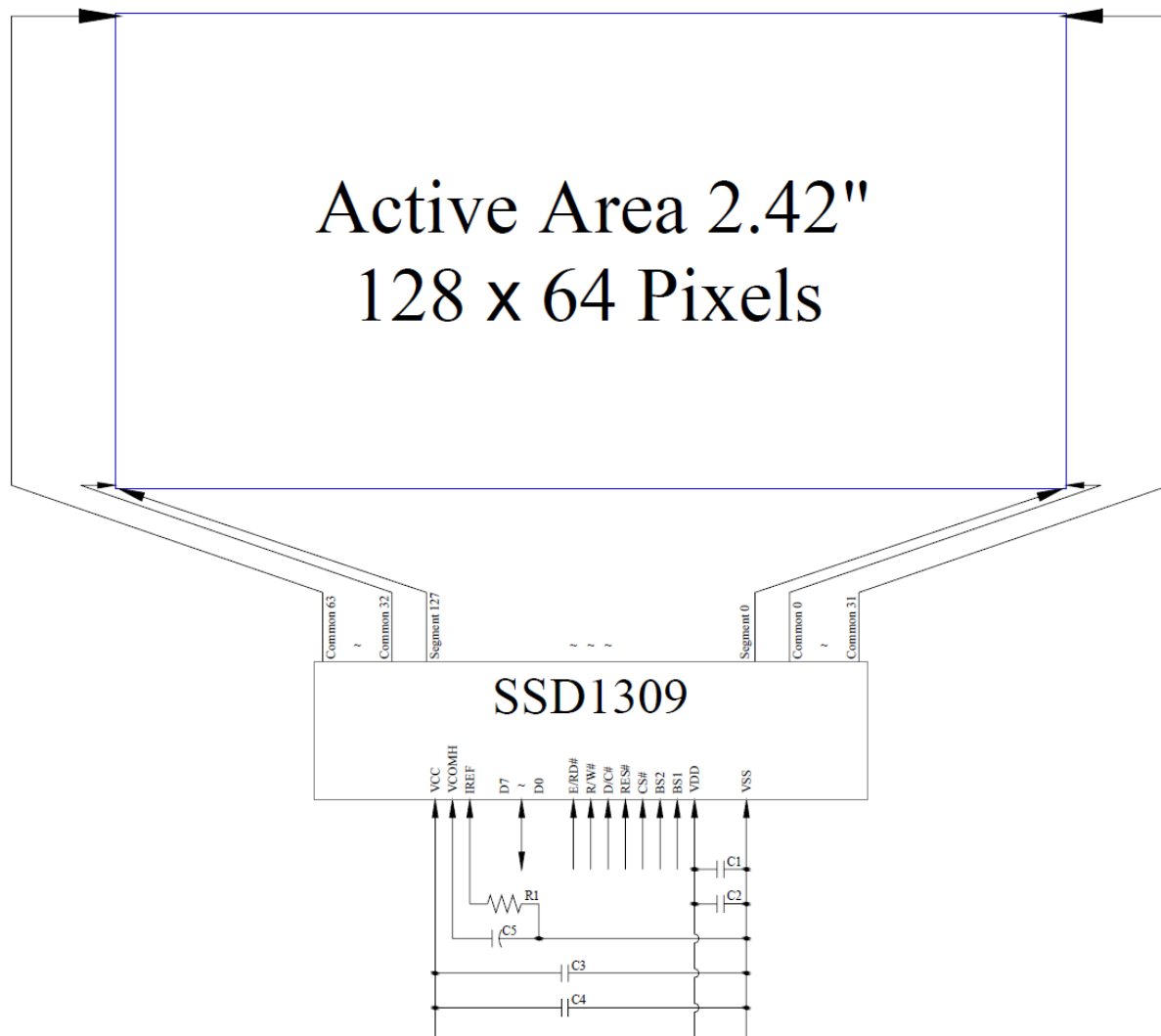

MCU Interface Selection: BS1 and BS2

Pins connected to MCU interface: D7~D0, E/RD#, R/W#, D/C#, RES# and CS#.

C1, C3: 0.1µF

C2: 4.7µF

C4: 10µF

C5: 4.7µF/25V Tantalum Capacitor

R1: 910 kΩ, $R1 = (\text{Voltage at IREF} - \text{BGGND}) / \text{IREF}$

Product No.	DD-12864GE-6K	REV. B

Page	12 / 34
------	---------

3.5 TIMING CHARACTERISTICS

3.5.1 AC CHARACTERISTICS

3.5.1.1 68XX-Series MPU Parallel Interface Timing Characteristics

VDD-VSS = 1.65V to 3.3V, Ta = 25°C

Symbol	Description	Min	Max	Unit
t _{cycle}	System Cycle Time	300	-	ns
t _{AS}	Address Setup Time	20	-	ns
t _{AH}	Address Hold Time	0	-	ns
t _{DW}	Data Write Time	80	-	ns
t _{DSW}	Write Data Setup Time	40	-	ns
t _{DHW}	Write Data Hold Time	20	-	ns
t _{DHR}	Read Data Hold Time	20	-	ns
t _{OH}	Output Disable Time	-	70	ns
t _{ACC}	Access Time	-	140	ns
PW _{CSL}	Chip Select Low Pulse Width (Read)	120	-	ns
	Chip Select Low Pulse width (Write)	60		
PW _{CSH}	Chip Select High Pulse Width (Read)	60	-	ns
	Chip Select High Pulse Width (Write)	60		
t _R	Rise Time	-	40	ns
t _F	Fall Time	-	40	ns

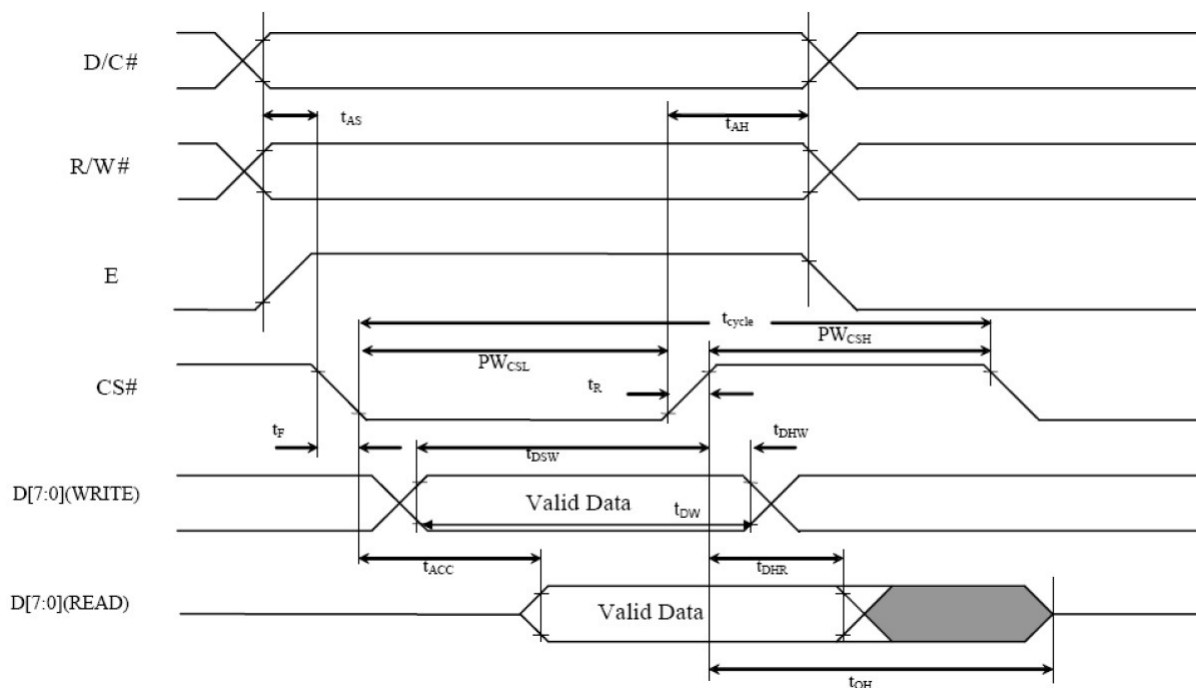

Product No.	DD-12864GE-6K	REV. B

Page	13 / 34
------	---------

3.5.1.2 8080-Series MPU Parallel Interface Timing Characteristics

VDD-VSS = 1.65V to 3.5V, Ta = 25°C

Symbol	Description	Min	Max	Unit
t _{cycle}	Clock Cycle Time	300	-	ns
t _{AS}	Address Setup Time	20	-	ns
t _{AH}	Address Hold Time	0	-	ns
t _{DW}	Data Write Time	70	-	ns
t _{DSW}	Write Data Setup Time	40	-	ns
t _{DHW}	Write Data Hold Time	15	-	ns
t _{DHR}	Read Data Hold Time	20	-	ns
t _{OH}	Output Disable Time	-	70	ns
t _{ACC}	Access Time	-	140	ns
t _{PWLR}	Read Low Time	120	-	ns
t _{PWLW}	Write Low Time	60	-	ns
t _{PWHR}	Read High Time	60	-	ns
t _{PWHW}	Write High Time	60	-	ns
t _{CS}	Chip Select Setup Time	0	-	ns
t _{CSH}	Chip Select Hold Time to Read Signal	0	-	ns
t _{CSF}	Chip Select Hold Time	20	-	ns
t _R	Rise Time	-	40	ns
t _F	Fall Time	-	40	ns

Read Timing

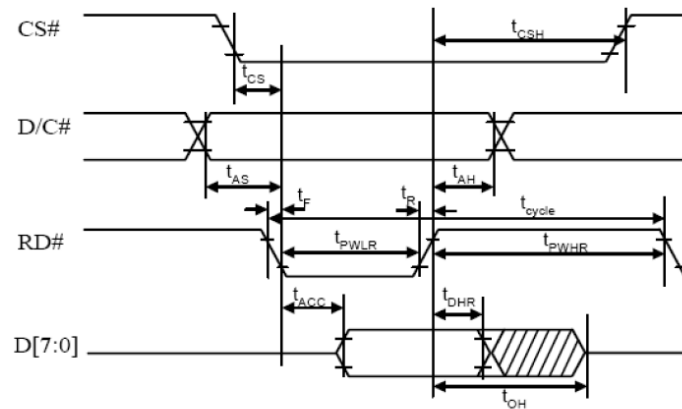

Write Timing

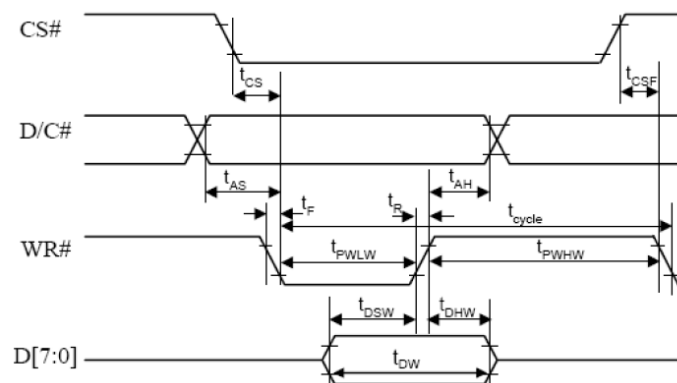

Product No.	DD-12864GE-6K	REV. B

Page	14 / 34
------	---------

3.5.1.3 Serial Interface Timing Characteristics

VDD-VSS = 1.65V to 3.5V, Ta = 25°C

Symbol	Description	Min	Max	Unit
t _{cycle}	Clock Cycle Time	100	-	ns
t _{AS}	Address Setup Time	15	-	ns
t _{AH}	Address Hold Time	15	-	ns
t _{CSS}	Chip Select Setup Time	20	-	ns
t _{CSH}	Chip Select Hold Time	50	-	ns
t _{DW}	Data Write Time	55	-	ns
t _{DSW}	Write Data Setup Time	15	-	ns
t _{DHW}	Write Data Hold Time	15	-	ns
t _{CLKL}	Serial Clock Low Time	50	-	ns
t _{CLKH}	Serial Clock High Time	50	-	ns
t _R	Rise Time	-	40	ns
t _F	Fall Time	-	40	ns

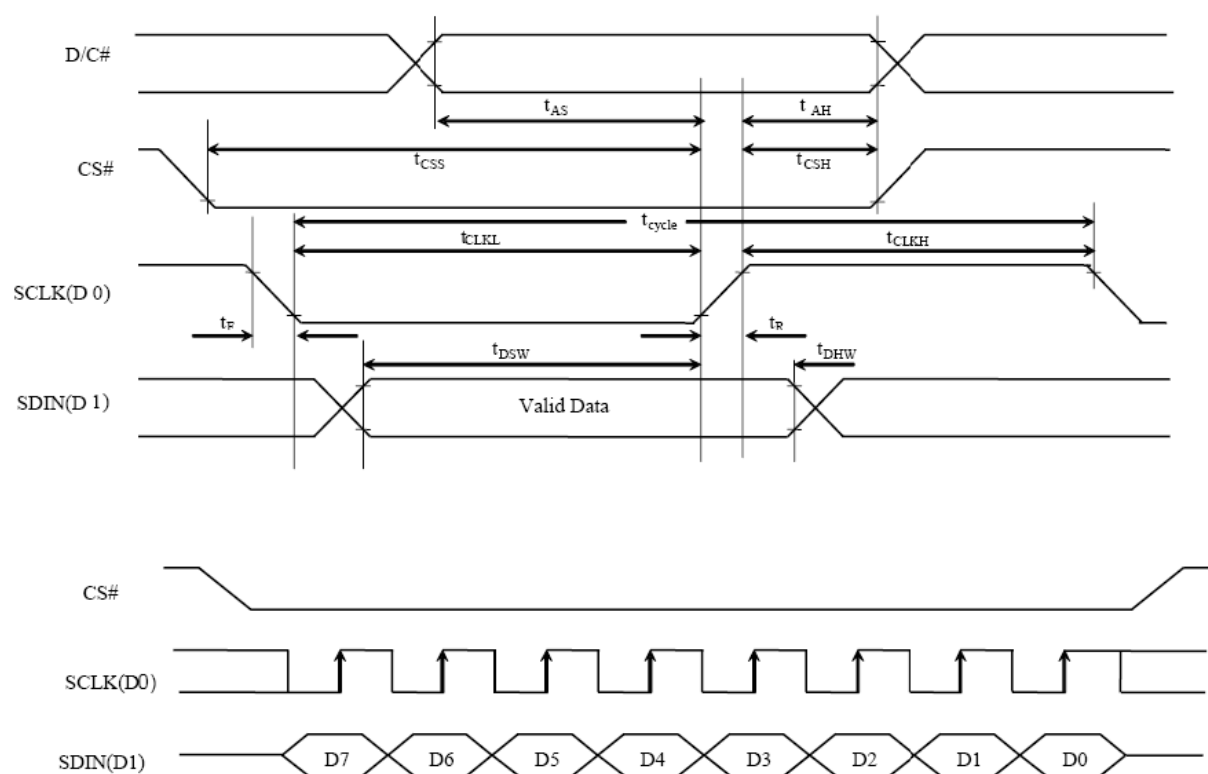

Product No.	DD-12864GE-6K	REV. B

Page	15 / 34
------	---------

3.5.1.4 I²C Interface Timing Characteristics

VDD-VSS = 1.65V to 3.5V, Ta = 25°C

Symbol	Description	Min	Max	Unit
t _{cycle}	Clock Cycle Time	2.5	-	us
t _{HSTART}	Start Condition Hold Time	0.6	-	us
t _{HD}	Data Hold Time (for “SDAOUT” Pin) Data	0	-	ns
	Hold Time (for “SDAIN” Pin)	300		
t _{SD}	Data Setup Time	100	-	ns
t _{SSTART}	Start Condition Setup Time (Only relevant for a repeated Start condition)	0.6	-	us
t _{SSTOP}	Stop Condition Setup Time	0.6	-	us
t _R	Rise Time for Data and Clock Pin		300	ns
t _F	Fall Time for Data and Clock Pin		300	ns
t _{IDLE}	Idle Time before a New Transmission can Start	1.3	-	us

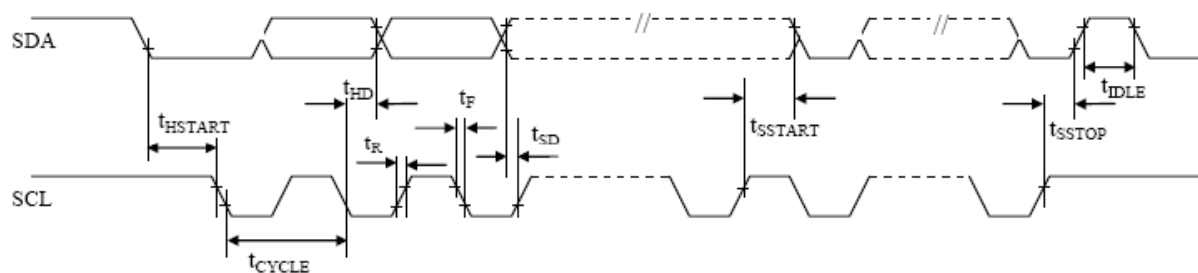

Product No.	DD-12864GE-6K	REV. B

Page	16 / 34
------	---------

4 OPTICAL SPECIFICATION

4.1 OPTICAL CHARACTERISTICS

Characteristics	Symbol	Condition	Min	Typ	Max	Unit
Brightness	L _{br}	Note 1	100	120	-	cd/m ²
C.I.E.(Green)	(X)	C.I.E. 1931	0.25	0.29	0.35	-
	(Y)		0.62	0.66	0.70	
Dark Room Contrast	CR		-	>10,000:1	-	-
Viewing Angle			-	Free	-	degree

Optical measurement taken at V_{DD} = 2.8V, V_{CC} = 13V.
Software configuration follows Section 5.4 Initialization

Note 1: Brightness (L_{br}) and Supply Voltage for Display (V_{CC}) are subject to the change of the panel characteristics and the customers request

Product No.	DD-12864GE-6K	REV. B

Page	17 / 34
------	---------

5 FUNCTIONAL SPECIFICATION

5.1 COMMANDS

Please refer to the Technical Manual for the SSD1309

5.2 POWER UP/DOWN SEQUENCE

To protect panel and extend the panel lifetime, the driver IC power up/down routine should include a delay period between high voltage and low voltage power sources during turn on/off. It gives the panel enough time to complete the action of charge and discharge before/after the operation.

5.2.1 POWER UP SEQUENCE

1. Power up V_{DD}
2. Send Display off command
3. Initialization
4. Clear Screen
5. Power up V_{CC}
6. Delay 100ms
(When V_{CC} is stable)
7. Send Display on command

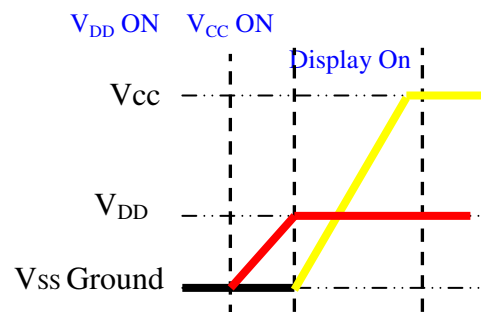

5.2.2 POWER DOWN SEQUENCE

1. Send Display off command
2. Power down V_{CC}
3. Delay 100ms
(When V_{CC} reaches 0 and panel is completely discharged)
4. Power down V_{DD}

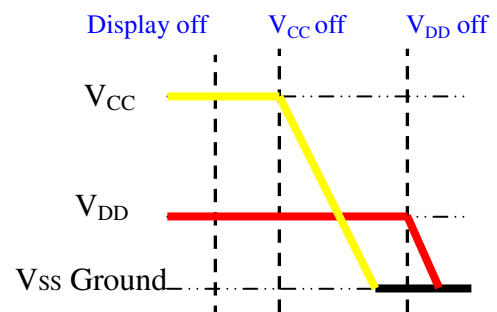

Conditions:

- 1) Since an ESD protection circuit is connected between V_{DD} and V_{CC} inside the driver IC, V_{CC} becomes lower than V_{DD} whenever V_{DD} is ON and V_{CC} is OFF.
- 2) V_{CC} should be kept float (disable) when it is OFF.
- 3) Power Pins (V_{DD} , V_{CC}) can never be pulled to ground under any circumstance.
- 4) V_{DD} should not be power down before V_{CC} power down.

Product No.	DD-12864GE-6K	REV. B

Page	18 / 34
------	---------

5.3 RESET CIRCUIT

When RES# input is low, the chip is initialized with the following status:

1. Display is OFF
2. 132x64 Display mode
3. Normal segment and display data column and row address mapping (SEG0 mapped to column address 00H and COM0 mapped to row address 00H)
4. Shift register data clear in serial interface
5. Display start line is set at display RAM address 0
6. Column address counter is set at 0
7. Normal scan direction of the COM outputs
8. Contrast control register is set at 7FH
9. Normal display mode (Equivalent to A4h command)

Product No.	DD-12864GE-6K	REV. B

Page	19 / 34
------	---------

5.4 ACTUAL APPLICATION EXAMPLE

Command usage and explanation of an actual example

<Power up Sequence>

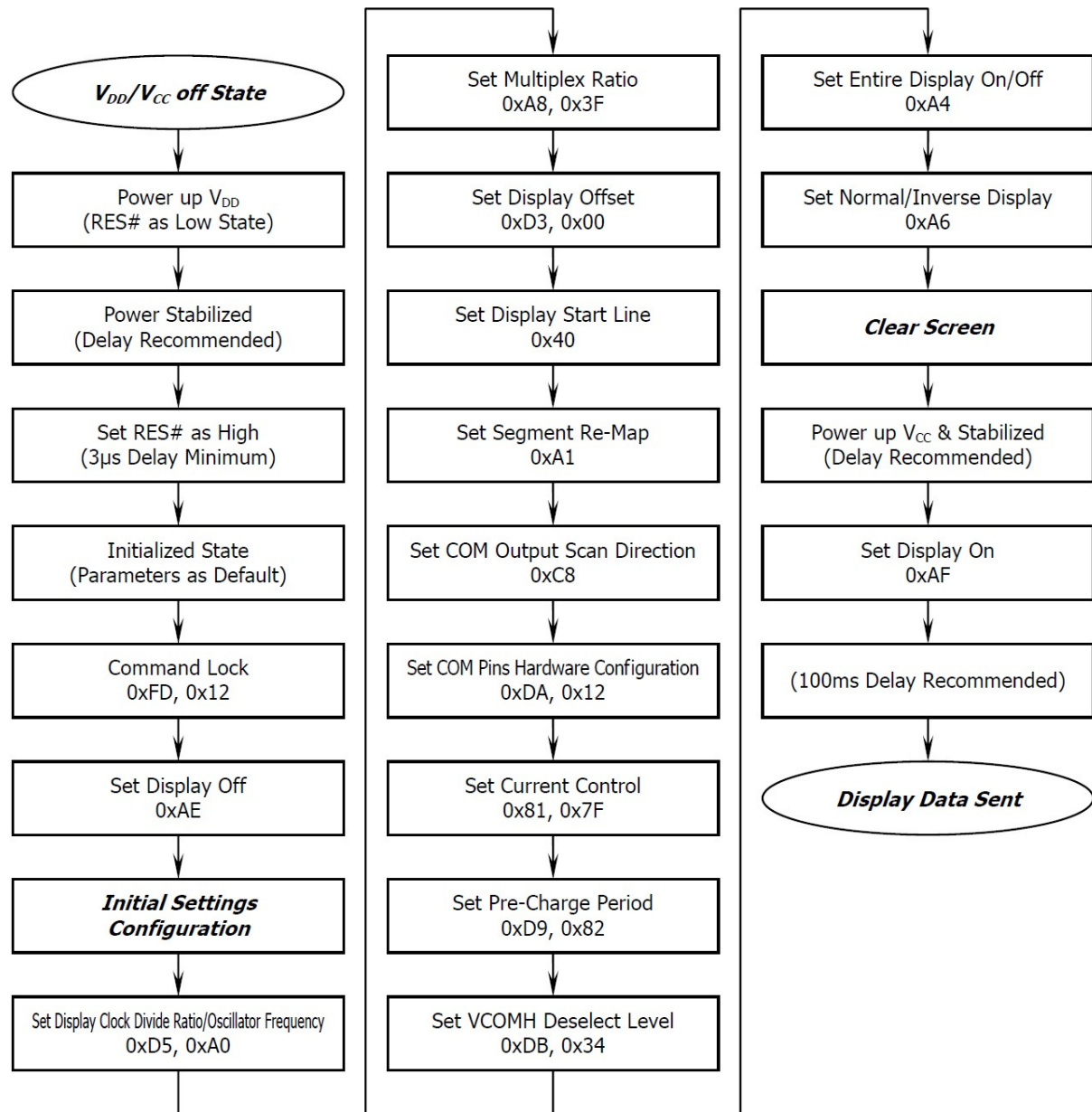

If the noise is accidentally occurred at the displaying window during the operation, please reset the display in order to recover the display function.

Product No.	DD-12864GE-6K	REV. B

Page	20 / 34
------	---------

<Power down Sequence>

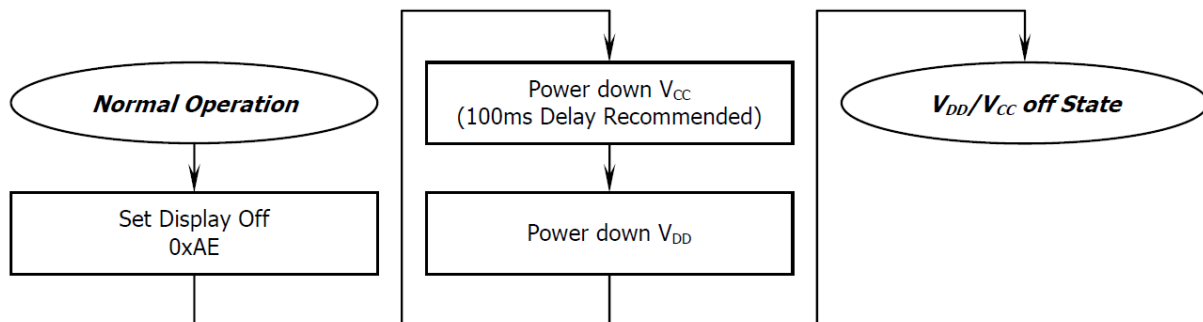

<Entering Sleep Mode>

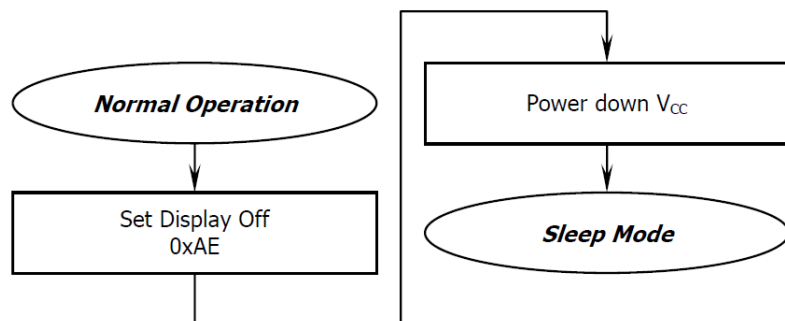

<Exiting Sleep Mode>

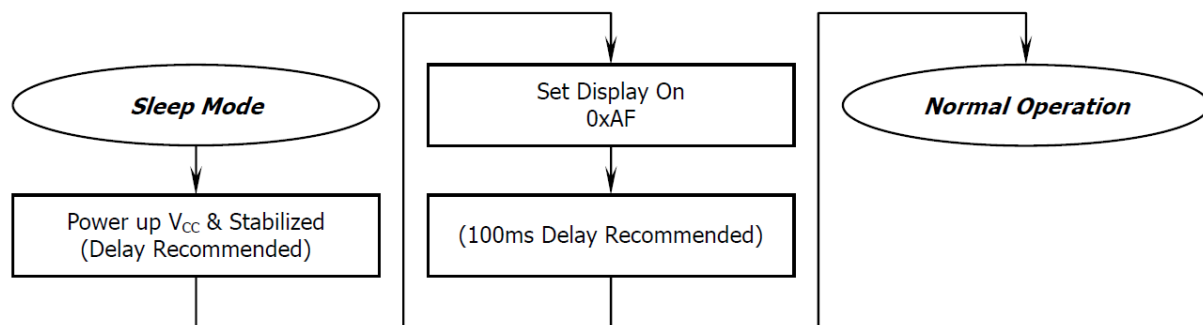

Product No.	DD-12864GE-6K	REV. B

Page	21 / 34
------	---------

6 PACKAGING AND LABELLING SPECIFICATION

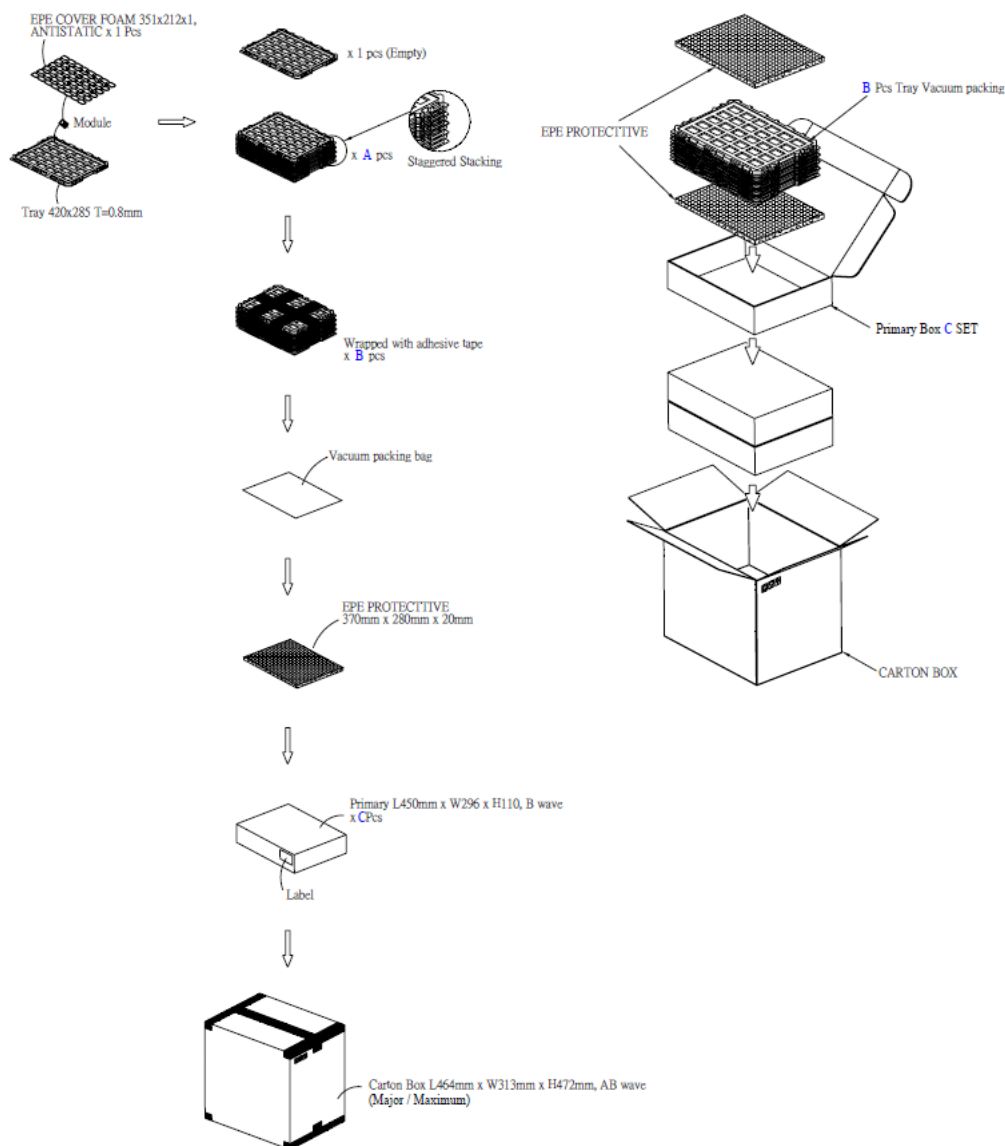

Item	Quantity
Holding Trays (A)	15 per Primary Box
Total Trays (B)	16 per Primary Box (Including 1 Empty Tray)
Primary Box (C)	1~4 per Carton (4 as Major / Maximum)

6.1 LABELLING & MARKING

DENSITRON
DD-12864GE-6B
TW YY MM

Product No.	DD-12864GE-6K	REV. B

Page	22 / 34
------	---------

7 QUALITY ASSURANCE SPECIFICATION

7.1 CONFORMITY

The performance, function and reliability of the shipped products conform to the Product Specification.

7.2 DELIVERY ASSURANCE

7.2.1 DELIVERY INSPECTION STANDARDS

IPC-AA610, class 2 electronic assemblies standard

7.2.2 Zone definition

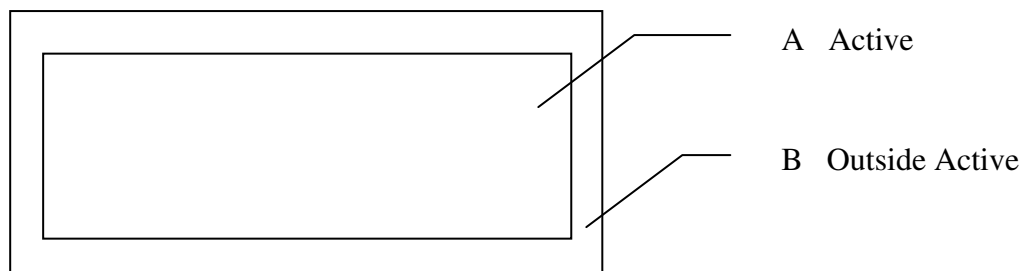

7.2.3 Visual inspection

Test and measurement to be conducted under following conditions :

Temperature:	23±5°C
Humidity:	55±15%RH
Fluorescent lamp:	30 W
Distance between the Panel & Eyes of the Inspector:	≥30cm
Distance between the Panel & the lamp:	≥50cm
Finger glove (or finger cover) must be worn by the inspector.	
Inspection table or jig must be anti-electrostatic	

Product No.	DD-12864GE-6K	REV. B

Page	23 / 34
------	---------

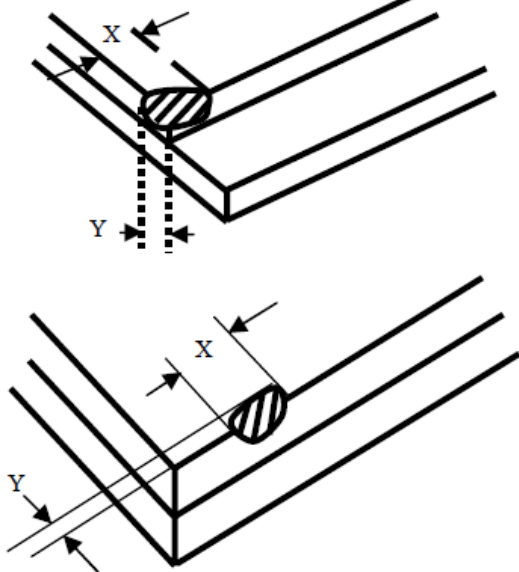

7.2.4 Standard of appearance inspection

Partition	AQL	Definition
Major	0.65	Defects in Pattern Check (Display On)
Minor	1.0	Defects in Cosmetic Check (Display Off)

Check Item	Classification	Criteria
Panel General Chipping	Minor	<p>$X > 6 \text{ mm}$ (Along with Edge) $Y > 1 \text{ mm}$ (Perpendicular to edge)</p> 

Product No.	DD-12864GE-6K	REV. B

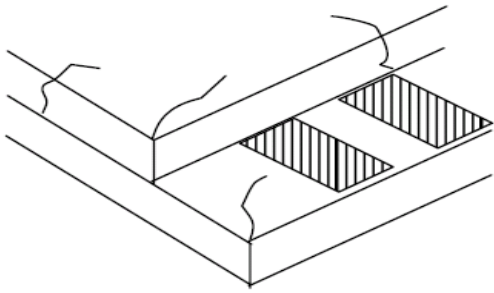
Page	24 / 34
------	---------

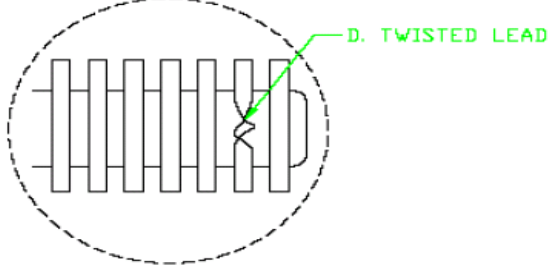
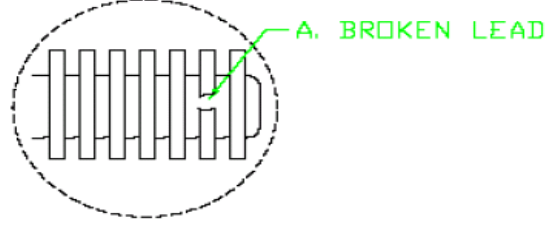
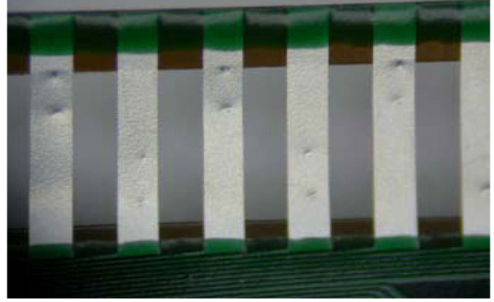
Check Item	Classification	Criteria
Panel Crack	Minor	Any crack is not allowable.  A 3D perspective diagram of a rectangular panel with a crack running across its top surface. The crack is shown as a jagged line.
Copper Exposed (Even Pin or Film)	Minor	Not Allowable by Naked Eye Inspection
Film or Trace Damage	Minor	 A close-up photograph of a yellow printed circuit board (PCB) showing a circular hole in the copper film, exposing the underlying substrate.
Terminal Lead Twist	Minor	Not Allowable  A diagram showing a row of terminal leads. One lead is twisted, indicated by a green arrow and the label 'D. TWISTED LEAD'.
Terminal Lead Broken	Minor	Not Allowable  A diagram showing a row of terminal leads. One lead is broken, indicated by a green arrow and the label 'A. BROKEN LEAD'.
Terminal Lead Prober Mark	Acceptable	 A photograph showing a row of terminal leads with small, dark marks on their top surfaces, which are identified as prober marks.

Product No.	DD-12864GE-6K	REV. B

Page	25 / 34
------	---------

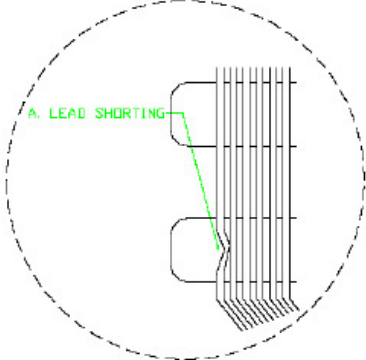
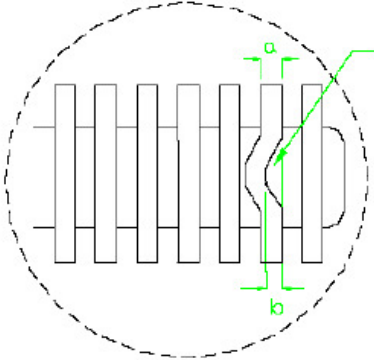
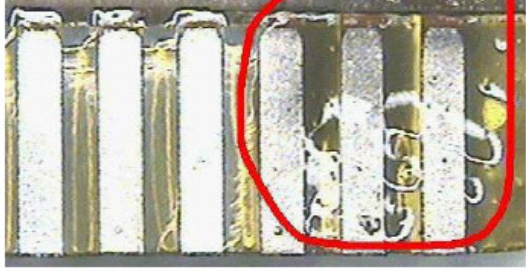
Check Item	Classification	Criteria
Terminal Lead Bent (Not Twist or Broken)	Minor	<p>NG if any bent lead cause lead shorting.</p> 
	Minor	<p>NG for horizontally bent lead more than 50% of its width.</p> 
Glue or Contamination on Pin (Couldn't Be Removed by Alcohol)	Minor	
Ink Marking on Back Side of panel (Exclude on Film)	Acceptable	Ignore for Any

Product No.	DD-12864GE-6K	REV. B

Page	26 / 34
------	---------

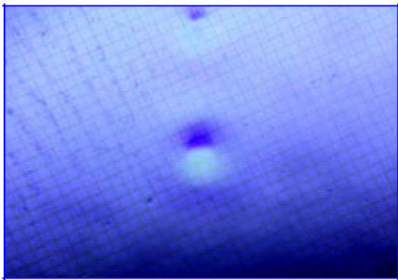
Check Item	Classification	Criteria
Any Dirt & Scratch on Polarizer's Protective Film	Acceptable	Ignore for not Affect the Polarizer
Scratches, Fiber, Line-Shape Defect (On Polarizer)	Minor	$W \leq 0.1$ Ignore $W > 0.1, L \leq 2$ $n \leq 1$ $L > 2$ $n = 0$
Dirt, Black Spot, Foreign Material, (On Polarizer)	Minor	$\Phi \leq 0.1$ Ignore $0.1 < \Phi \leq 0.25$ $n \leq 1$ $0.25 < \Phi$ $n = 0$
Dent, Bubbles, White spot (Any Transparent Spot on Polarizer)	Minor	$\Phi \leq 0.5$ → Ignore if no Influence on Display $0.5 < \Phi$ $n = 0$ 
Fingerprint, Flow Mark (On Polarizer)	Minor	Not Allowable

* Protective film should not be tear off when cosmetic check.

** Definition of W & L & Φ (Unit: mm): $\Phi = (a + b) / 2$

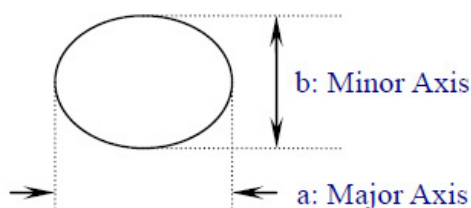
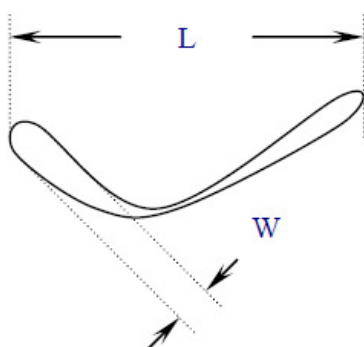

Product No.	DD-12864GE-6K	REV. B

Page	27 / 34
------	---------

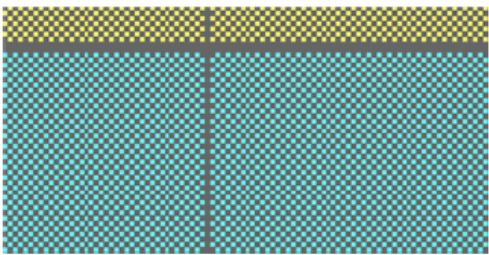
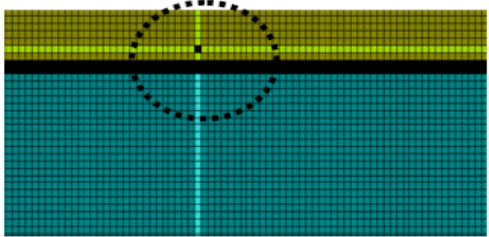
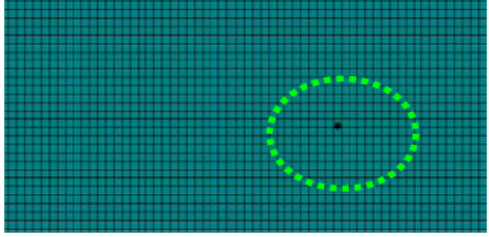
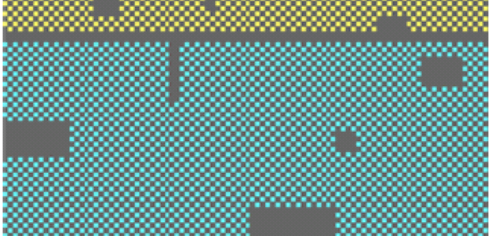
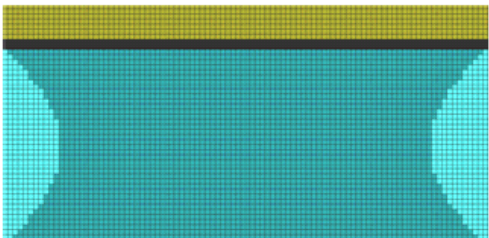
Check Item	Classification	Criteria
No Display	Major	
Flicker	Major	Not Allowable
Missing Line	Major	
Pixel Short	Major	
Darker Pixel	Major	
Wrong Display	Major	
Un-uniform	Major	

Product No.	DD-12864GE-6K	REV. B

Page	28 / 34
------	---------

7.3 DEALING WITH CUSTOMER COMPLAINTS

7.3.1 Non-conforming analysis

Purchaser should supply Densitron with detailed data of non-conforming sample.
 After accepting it, Densitron should complete the analysis in two weeks from receiving the sample.
 If the analysis cannot be completed on time, Densitron must inform the purchaser.

7.3.2 Handling of non-conforming displays

If any non-conforming displays are found during customer acceptance inspection which Densitron is clearly responsible for, return them to Densitron.
 Both Densitron and customer should analyse the reason and discuss the handling of non-conforming displays when the reason is not clear.
 Equally, both sides should discuss and come to agreement for issues pertaining to modification of Densitron quality assurance standard.

Product No.	DD-12864GE-6K	REV. B

Page	29 / 34
------	---------

8 RELIABILITY SPECIFICATION

8.1 RELIABILITY TESTS

Test Item	Test Condition	Evaluation and assessment
High Temperature Operation	70°C, 240 hours	No abnormalities in function and appearance
Low Temperature Operation	-40°C, 240 hours	No abnormalities in function and appearance
High Temperature Storage	85°C, 240 hours	No abnormalities in function and appearance
Low Temperature Storage	-40°C, 240 hours	No abnormalities in function and appearance
High Temperature & High Humidity Storage	60°C, 90%RH, 120 hours	No abnormalities in function and appearance
Thermal Shock	-40°C ↔ 85°C, 24 cycle 60 mins dwell	No abnormalities in function and appearance

- The samples used for above tests do not include polarizer.
- No moisture condensation is observed during tests.

8.1.1 FAILURE CHECK STANDARD

After the completion of the described reliability test, the samples were left at room temperature for 2 hrs prior to conducting the failure test at 23±5 °C; 55±15% RH

8.2 LIFE TIME

Item	Description	
1	Function, performance, appearance, etc. shall be free from remarkable deterioration more than 20,000 hours at 120 cd/m ² under ordinary operating conditions of room temperature (25±10 °C), normal humidity (45±20% RH), and in area not exposed to direct sunlight. VCC = 13.0V, Ta = 25°C, 50% Checkerboard. Software configuration follows Section 5.4 Initialization.	
	Life Time (120 cd/m ²)	20,000 hr
	Life Time (80 cd/m ²)	40,000 hr
2	End of lifetime is specified as 50% of initial brightness reached. The average operating lifetime at room temperature is estimated by the accelerated operation at high temperature conditions.	

8.3 FAILURE CHECK STANDARD

After the completion of the described reliability test, the samples were left at room temperature for 2 hrs prior to conducting the failure test at 23±5°C; 55±15% RH.

Product No.	DD-12864GE-6K	REV. B

Page	30 / 34
------	---------

9 HANDLING PRECAUTIONS

9.1 HANDLING PRECAUTIONS

- 1) Since the display panel is being made of glass, do not apply mechanical impacts such as dropping from a high position.
- 2) If the display panel is broken by some accident and the internal organic substance leaks out, be careful not to inhale nor lick the organic substance.
- 3) If pressure is applied to the display surface or its neighborhood of the OEL display module, the cell structure may be damaged and be careful not to apply pressure to these sections.
- 4) The polarizer covering the surface of the OEL display module is soft and easily scratched. Please be careful when handling the OEL display module.
- 5) When the surface of the polarizer of the OEL display module has soil, clean the surface. It takes advantage of by using following adhesion tape.
 - * Scotch Mending Tape No. 810 or an equivalent
 Never try to breathe upon the soiled surface nor wipe the surface using cloth containing solvent such as ethyl alcohol, since the surface of the polarizer will become cloudy.
 Also, pay attention that the following liquid and solvent may spoil the polarizer:
 - * Water
 - * Ketone
 - * Aromatic Solvents
- 6) Hold OEL display module very carefully when placing OEL display module into the system housing. Do not apply excessive stress or pressure to OEL display module. And, do not over bend the film with electrode pattern layouts. These stresses will influence the display performance. Also, secure sufficient rigidity for the outer cases.

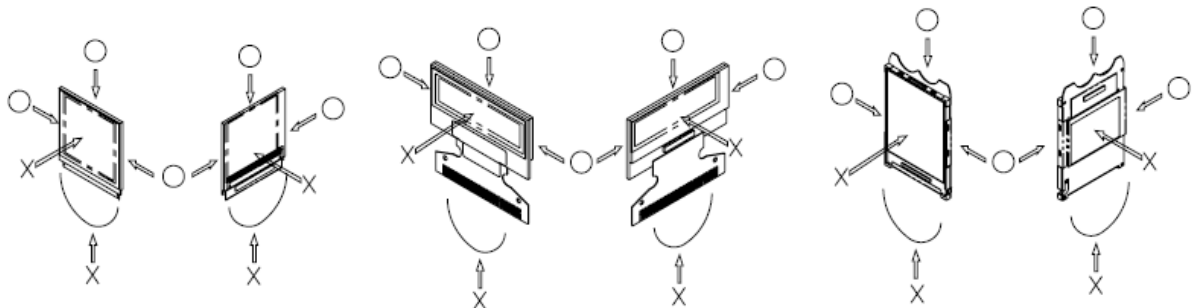

- 7) Do not apply stress to the LSI chips and the surrounding molded sections.
- 8) Do not disassemble nor modify the OEL display module.
- 9) Do not apply input signals while the logic power is off.
- 10) Pay sufficient attention to the working environments when handing OEL display modules to prevent occurrence of element breakage accidents by static electricity.
 - * Be sure to make human body grounding when handling OEL display modules.
 - * Be sure to ground tools to use or assembly such as soldering irons.
 - * To suppress generation of static electricity, avoid carrying out assembly work under dry environments.

Product No.	DD-12864GE-6K	REV. B

Page	31 / 34
------	---------

* Protective film is being applied to the surface of the display panel of the OEL display module. Be careful since static electricity may be generated when exfoliating the protective film.

- 11) Protection film is being applied to the surface of the display panel and removes the protection film before assembling it. At this time, if the OEL display module has been stored for a long period of time, residue adhesive material of the protection film may remain on the surface of the display panel after removed of the film. In such case, remove the residue material by the method introduced in the above Section 5).
- 12) If electric current is applied when the OEL display module is being dewed or when it is placed under high humidity environments, the electrodes may be corroded and be careful to avoid the above.

9.2 STORAGE PRECAUTIONS

- 1) When storing OEL display modules, put them in static electricity preventive bags avoiding exposure to direct sun light nor to lights of fluorescent lamps, etc. and, also, avoiding high temperature and high humidity environments or low temperature (less than 0°C) environments. (We recommend you to store these modules in the packaged state when they were shipped from Densitron Technologies Plc.) At that time, be careful not to let water drops adhere to the packages or bags nor let dewing occur with them.
- 2) If electric current is applied when water drops are adhering to the surface of the OEL display module, when the OEL display module is being dewed or when it is placed under high humidity environments, the electrodes may be corroded and be careful about the above.

9.3 DESIGNING PRECAUTIONS

- 1) The absolute maximum ratings are the ratings which cannot be exceeded for OEL display module, and if these values are exceeded, panel damage may be happen.
- 2) To prevent occurrence of malfunctioning by noise, pay attention to satisfy the VIL and VIH specifications and, at the same time, to make the signal line cable as short as possible.
- 3) We recommend you to install excess current preventive unit (fuses, etc.) to the power circuit (VDD). (Recommend value: 0.5A)
- 4) Pay sufficient attention to avoid occurrence of mutual noise interference with the neighboring devices.
- 5) As for EMI, take necessary measures on the equipment side basically.
- 6) When fastening the OEL display module, fasten the external plastic housing section.
- 7) If power supply to the OEL display module is forcibly shut down by such errors as taking out the main battery while the OEL display panel is in operation, we cannot guarantee the quality of this OEL display module.
- 8) The electric potential to be connected to the rear face of the IC chip should be as follows: US2066
* Connection (contact) to any other potential than the above may lead to rupture of the IC.

Product No.	DD-12864GE-6K	REV. B

Page	32 / 34
------	---------

9.4 OTHER PRECAUTIONS

- 1) When an OEL display module is operated for a long of time with fixed pattern may remain as an after image or slight contrast deviation may occur. Nonetheless, if the operation is interrupted and left unused for a while, normal state can be restored. Also, there will be no problem in the reliability of the module.
- 2) To protect OEL display modules from performance drops by static electricity rapture, etc., do not touch the following sections whenever possible while handling the OEL display modules.
 - * Pins and electrodes
 - * Pattern layouts such as the FPC
- 3) With this OEL display module, the OEL driver is being exposed. Generally speaking, semiconductor elements change their characteristics when light is radiated according to the principle of the solar battery. Consequently, if this OEL driver is exposed to light, malfunctioning may occur.
 - * Design the product and installation method so that the OEL driver may be shielded from light in actual usage.
 - * Design the product and installation method so that the OEL driver may be shielded from light during the inspection processes.
- 4) Although this OEL display module stores the operation state data by the commands and the indication data, when excessive external noise, etc. enters into the module, the internal status may be changed. It therefore is necessary to take appropriate measures to suppress noise generation or to protect from influences of noise on the system design.
- 5) We recommend you to construct its software to make periodical refreshment of the operation statuses (re-setting of the commands and re-transference of the display data) to cope with catastrophic noise.

9.5 PRECAUTIONS WHEN DISPOSING OF THE OEL DISPLAY MODULES

- 1) Request the qualified companies to handle industrial wastes when disposing of the OEL display modules. Or, when burning them, be sure to observe the environmental and hygienic laws and regulations.

Product No.	DD-12864GE-6K	REV. B

Page	33 / 34
------	---------

10 SUPPORTED ACCESSORIES

10.1 DUO KIT

Densitron has developed an easy to use yet powerful development and demonstration tool for driving its range of Passive Matrix OLED displays from the USB port of a PC.

DUO (Densitron USB OLED) kit is hot pluggable and does not require extra cables or power supply to run, allowing users to be up and running in minutes.

The kit consists of an OLED display with transition Board, USB controller card, mini USB cable and a CD with software application and drivers.



Part number: UNDER DEVELOPMENT

10.2 TRANSITION BOARD CARD

A Transition board card is like a daughterboard which is meant to be a circuit board for connections between the baseboards (DUO).

It has connector pins for interfacing between the display and the baseboards.

It also includes the OLED display.

Part number: UNDER DEVELOPMENT

10.3 CONNECTOR BOARD CARD

A Connector board card is also a daughterboard which is a circuit board for connection between a microprocessor or microcontroller (customer's system).

Part number: EVK-CONNECT-015

10.4 CONNECTOR

Type: ZIF connector

No. of connections	Pitch (mm)	Manufacturer	Manufacturer part no.	Distributor part no.
24	0.50	Omron	XF2M-2415-1A	Farnell/1112559 Digikey/ OR721CT-ND

Product No.	DD-12864GE-6K	REV. B

Page	34 / 34
------	---------