

# LIQUID CRYSTAL DISPLAY MODULE

## Product Specification

<b>CUSTOMER</b>	<b>Standard</b>
<b>CUSTOMER PART NUMBER</b>	
<b>PRODUCT NUMBER</b>	<b>DET150XGNLNT0M-1A</b>

Product Mgr	Design Eng
<b>Bruno Recaldini</b>	<b>Sunny</b>
Date: 02-Jan-14	Date: 02-Jan-14

## TABLE OF CONTENTS

<b>1</b>	<b>MAIN FEATURES</b> .....	<b>4</b>
<b>2</b>	<b>MECHANICAL SPECIFICATION</b> .....	<b>5</b>
2.1	MECHANICAL CHARACTERISTICS.....	5
2.2	MECHANICAL DRAWING.....	6
<b>3</b>	<b>ELECTRICAL SPECIFICATION</b> .....	<b>7</b>
3.1	ABSOLUTE MAXIMUM RATINGS.....	7
3.2	ELECTRICAL CHARACTERISTICS.....	8
3.3	INTERFACE PIN ASSIGNMENT .....	9
3.4	TIMING CHARACTERISTICS .....	11
3.5	BLOCK DIAGRAM .....	12
3.6	PIXEL DATA FORMAT .....	13
3.7	POWER SEQUENCE .....	14
<b>4</b>	<b>OPTICAL SPECIFICATION</b> .....	<b>15</b>
4.1	OPTICAL CHARACTERISTICS .....	15
<b>5</b>	<b>BACKLIGHT SPECIFICATION</b> .....	<b>17</b>
5.1	LED INTERFACE PIN ASSIGNMENT .....	17
5.2	PARAMETER GUIDELINE OF LED BACKLIGHT .....	17
<b>6</b>	<b>QUALITY ASSURANCE SPECIFICATION</b> .....	<b>18</b>
6.1	DELIVERY INSPECTION STANDARDS .....	18
6.2	DEALING WITH CUSTOMER COMPLAINTS.....	24
<b>7</b>	<b>RELIABILITY SPECIFICATION</b> .....	<b>25</b>
7.1	RELIABILITY TESTS.....	25
<b>8</b>	<b>HANDLING PRECAUTIONS</b> .....	<b>26</b>

**REVISION RECORD**

<b>Rev.</b>	<b>Date</b>	<b>Page</b>	<b>Chapt.</b>	<b>Comment</b>	<b>ECN no.</b>
1.0	02-Jan-14			Initial Release	

## 1 MAIN FEATURES

ITEM	CONTENTS
Screen Size	15.0" Diagonal
Display Format	1024 x RGB x 768 Dots
N° of Colour	16.7M
Overall Dimensions	326.5 mm (H) x 253.5 mm (V) x 12.0 mm (D)
Active Area	304.128 mm (H) x 228.096 mm (V)
LCD Type	TFT
Mode	MVA Transmissive / Normally White
Viewing Direction	Full view
Electrical Interface	LVDS
Backlight Type	LED
Operating Temperature	-20°C ~ +70°C
Storage Temperature	-30°C ~ +80°C
RoHS compliant	Yes

## 2 MECHANICAL SPECIFICATION

### 2.1 MECHANICAL CHARACTERISTICS

---

ITEM	CHARACTERISTIC	UNIT
Display Format	1024 x RGB x 768 Dots	Dots
Overall Dimensions	326.5 (H) x 253.5 (V) x 12.0 (D)	mm
Active Area	304.128 (H) x 228.096 (V)	mm
pixel Pitch	0.297 (H) x 0.297 (V)	mm
Weight	930 (MAX)	g

## 2.2 MECHANICAL DRAWING

Fig1: Reference outline drawing: Front side

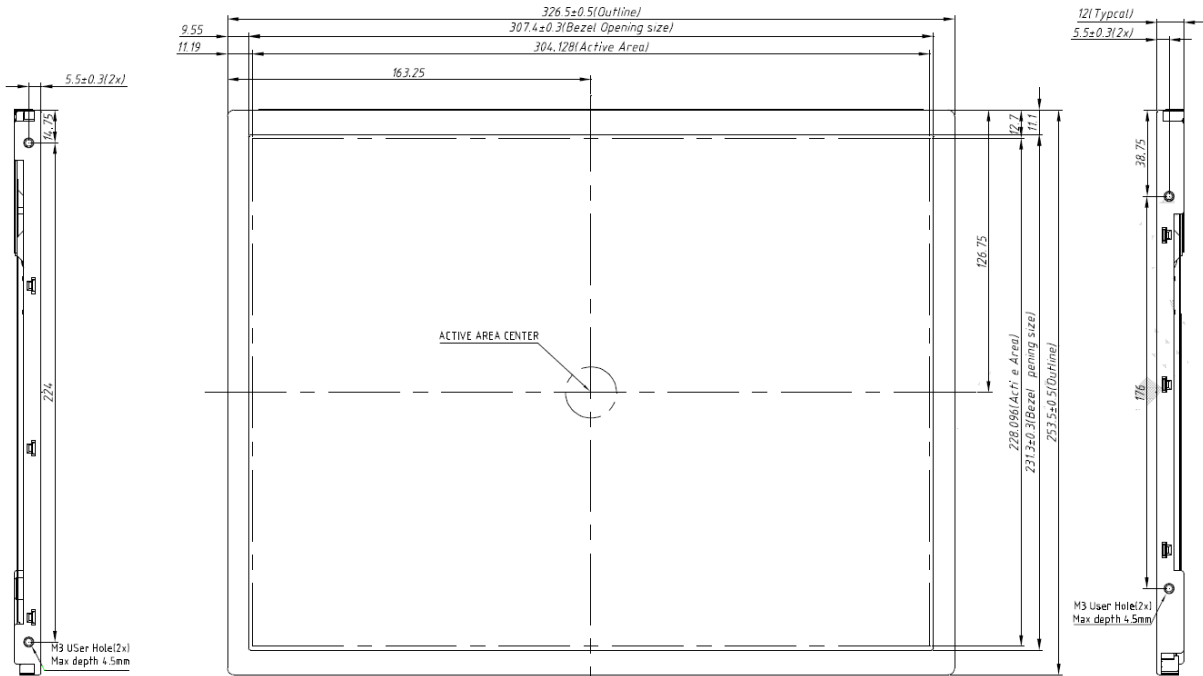
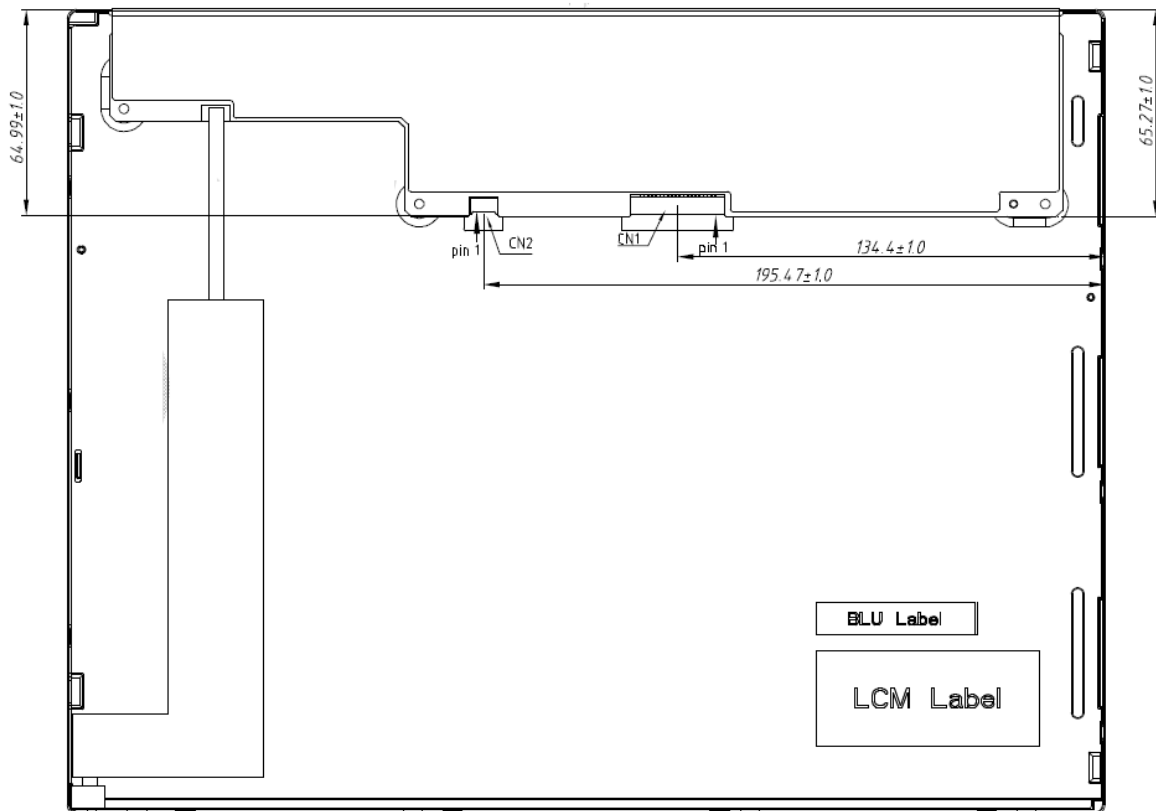

Fig2: Reference outline drawing: Back side



### 3 ELECTRICAL SPECIFICATION

#### 3.1 ABSOLUTE MAXIMUM RATINGS

Item	Symbol	Condition	Min	Max	Unit	Note
Operating Temperature	TOP		-20	70	°C	1
Storage Temperature	TST		-30	80	°C	1,2,3
Operating Humidity	HOP		10	85	%RH	4
Storage Humidity	HST		10	95	%RH	4
Supply Voltage	VDD		-0.5	5	V	5

Please make sure to keep the temperature of LCD module is less than 80°C

Note 1. 90 % RH Max for Ta<50 °C, and 60% RH for Ta≥50°C.

Note 2. In case of below 0°C, the response time of liquid crystal (LC) becomes slower and the colour of panel becomes darker than normal one. Level of retardation depends on temperature, because of LC's characteristic.

Note 3. Only operation is guaranteed at operating temperature. Contrast, response time, another display quality are evaluated at +25°C.

Note 4. Storage Range & Operating Range Picture:

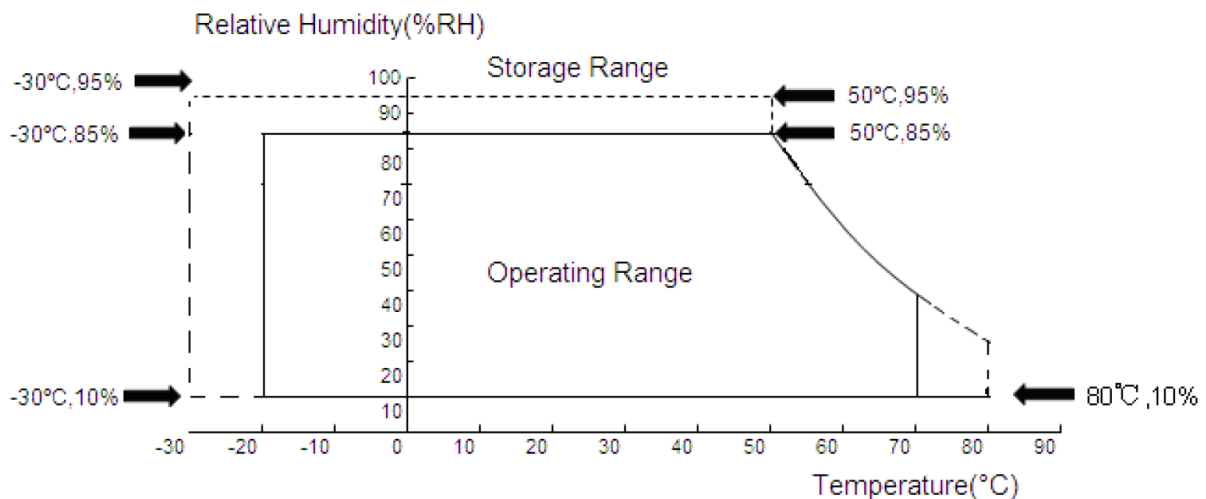

Fig 3: Storage Range & Operating Range Picture

Note 5. Humidity: 85%RH MAX (T<40°C) Note static electricity. Maximum wet bulb temperature at 39°C or less. (T>40°C) No condensation.

### 3.2 ELECTRICAL CHARACTERISTICS

Item		Symbol	Min.	Typ.	Max.	Units	Condition
LCD Drive Voltage (Logic)		VDD	3.0	3.3	3.6	V	-
VDD Current	Black Pattern	IDD	-	250	-	mA	3.3V/Black pattern
VDD Power Consumption	Black Pattern	PDD	-	-	1.3	W	Black Pattern, 60Hz
Rush Current		Irush	-	-	3	A	Note1
Allowable Logic/LCD Drive Ripple Voltage		VDDrp	-	-	200	[mV]p-p	Note2

Note1: Measure condition

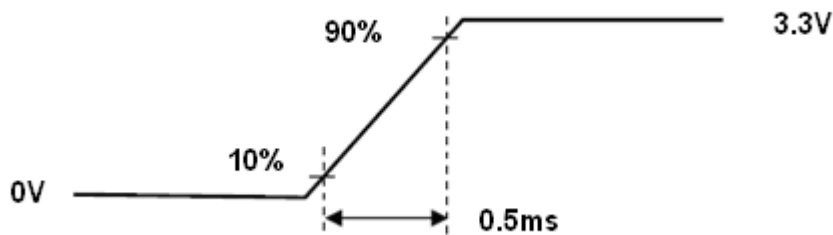

Fig 4: VDD Rising Time

Note 2: VDD Power Dip condition

If  $V_{TH} < VDD \leq V_{min}$ , then  $t_d \leq 10ms$ ; When the voltage returns to normal our panel must revive automatically.

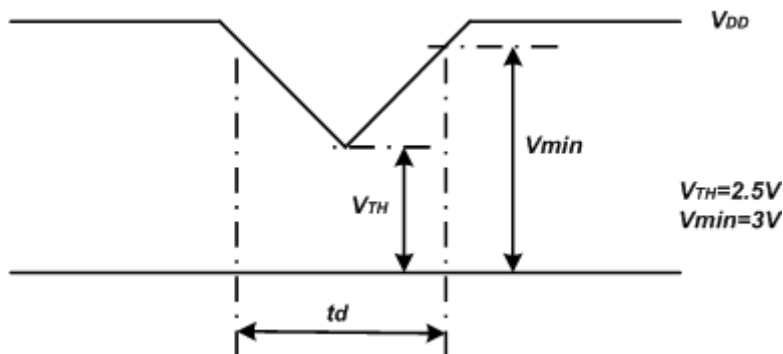

Fig 5: VDD Power Dip

If  $V_{TH} < VDD \leq V_{min}$ : When the voltage return to normal our panel must revive automatically.



### 3.3 INTERFACE PIN ASSIGNMENT

#### 3.3.1 SIGNAL PIN ASSIGNMENT

Item: FDP Down Connector (20 pin pitch=1.25mm)

Connector recommended model: MSB 240420HD

Pin #	Signal Name	Description	Remarks
1	VDD	LCD power supply (Typ. +3.3V)	
2	VDD	LCD power supply (Typ. +3.3V)	
3	VSS	Ground	
4	REV	Revers Scan Selection	Note
5	Rin1-	-LVDS differential data input (R0-R5,G0)	
6	Rin1+	+LVDS differential data input (R0-R5, G0)	
7	VSS	Ground	
8	Rin2-	-LVDS differential data input	
9	Rin2+	+LVDS differential data input	
10	VSS	Ground	
11	Rin3-	-LVDS differential data input	
12	Rin3+	+LVDS differential data input	
13	VSS	GND	
14	ClkIN-	-LVDS differential clock input	
15	ClkIN+	+LVDS differential clock input	
16	GND	GND	
17	Rin4-	-LVDS differential data input	
18	Rin4+	+LVDS differential data input	
19	VSS	Ground	
20	NC	Not connect	

Note1: REV=LOW/NC

Gate scan: Y1→Y2→Y3

Y1:G1→G2--→G258

Source scans: X1→X2→X3→X4→X5

X1:S1→S2--→S600

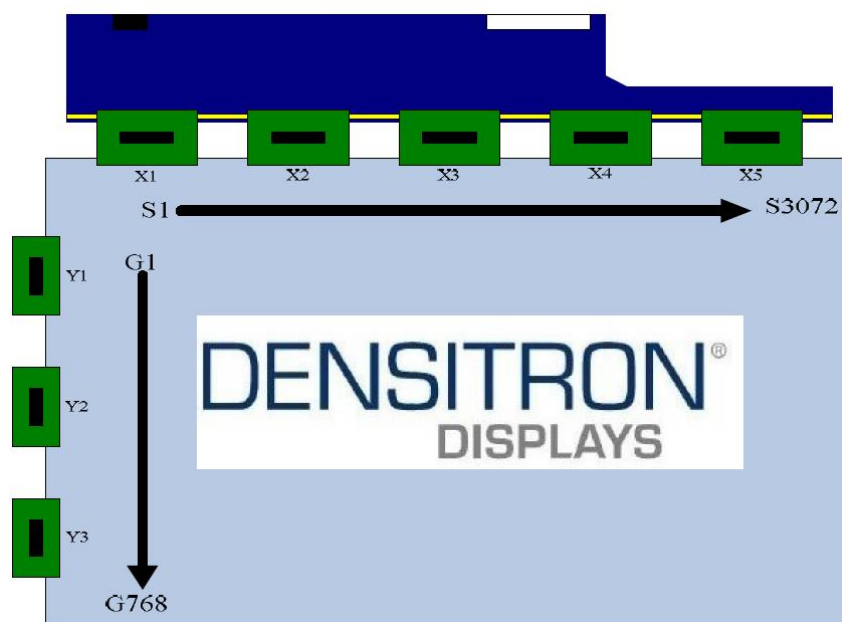

Note2: REV= High

Gate scan: Y3→Y2→Y1

Y1:G258→G257--→G1

Source scans: X5→X4→X3→X2→X1

X1:S600→S599--→S1

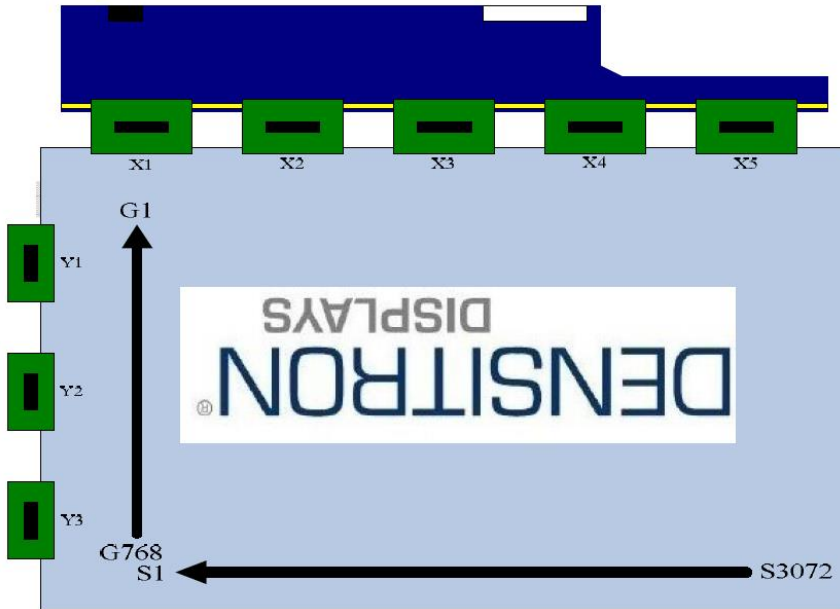

### 3.4 TIMING CHARACTERISTICS

#### 3.4.1 Interface timings

Synchronization Method: DE only

Parameter	Symbol	Unit	Min.	Typ.	Max.
LVDS Clock Frequency <single >	fdck	MHz	50	65	80
H Total Time	Thp	clocks	1056	1344	1720
H Active Time	HA	clocks	1024	1024	1024
H Front Porch	Thfp	clocks	-	48	-
H Sync Pulse Width	HSPW	clocks	-	32	-
H Back Porch	Thbp	clocks	-	240	-
H Frequency	fh	kHz	46.32	48.36	59.40
V Total Time	Tvp	lines	772	806	990
V Active Time	VA	lines	768	768	768
V Front Porch	Tvfp	lines	-	3	-
V Sync Pulse Width	VSPW	lines	-	12	-
V Back Porch	Tvbp	lines	-	23	-
V Frequency	fv	Hz	-	60	-

Note: H Blanking Time and V Blanking Time can not be changed at every frame

#### 3.4.2 Timing Diagram of Interface Signal

Fig 6: Timing Characteristics

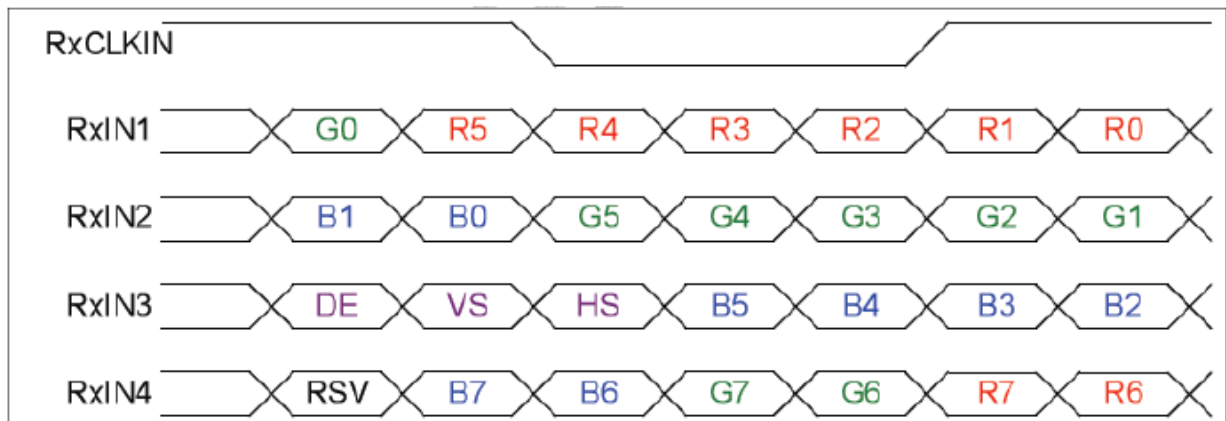

Note1: Follow SPWG

Note2: R/G/B data7: MSB, R/G/B data0: LSB

### 3.5 BLOCK DIAGRAM

It shows the functional block diagram of the LED module.

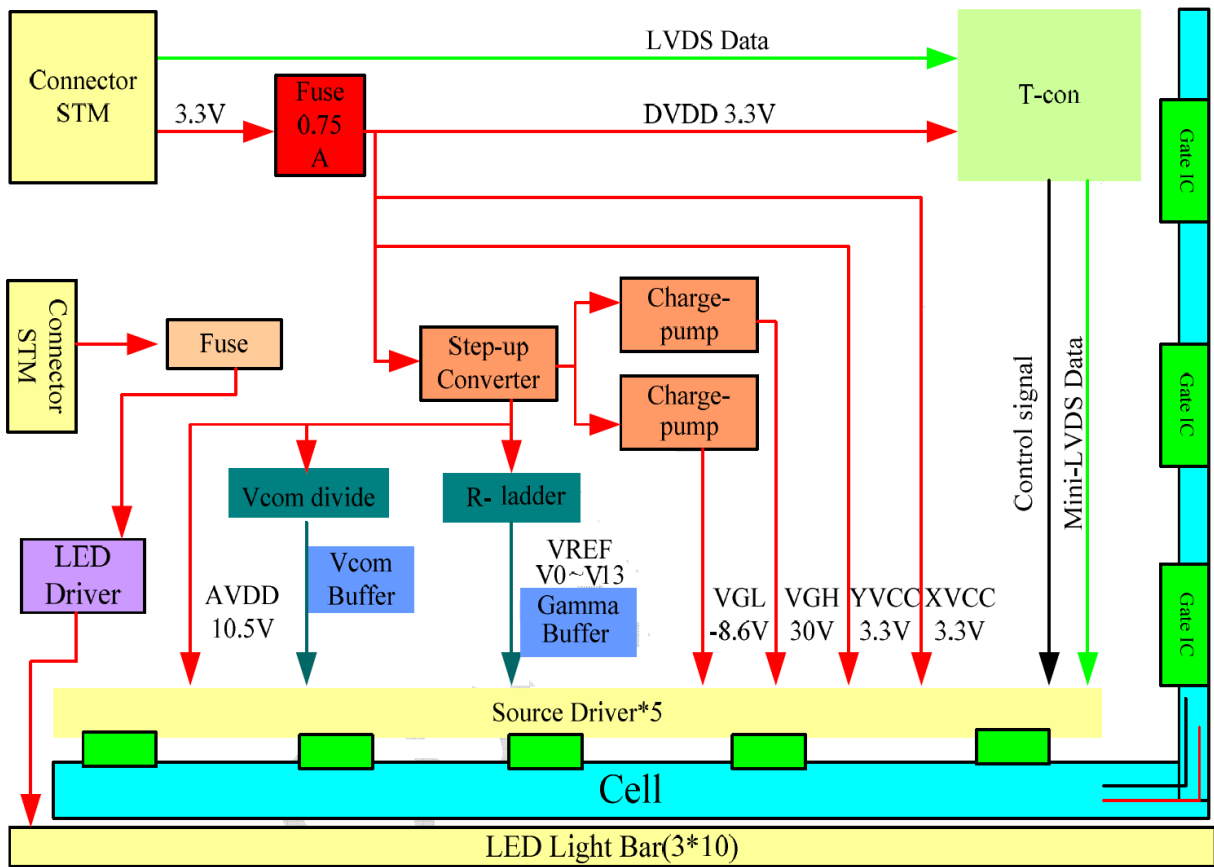

Fig 7: functional block diagram

### 3.6 PIXEL DATA FORMAT

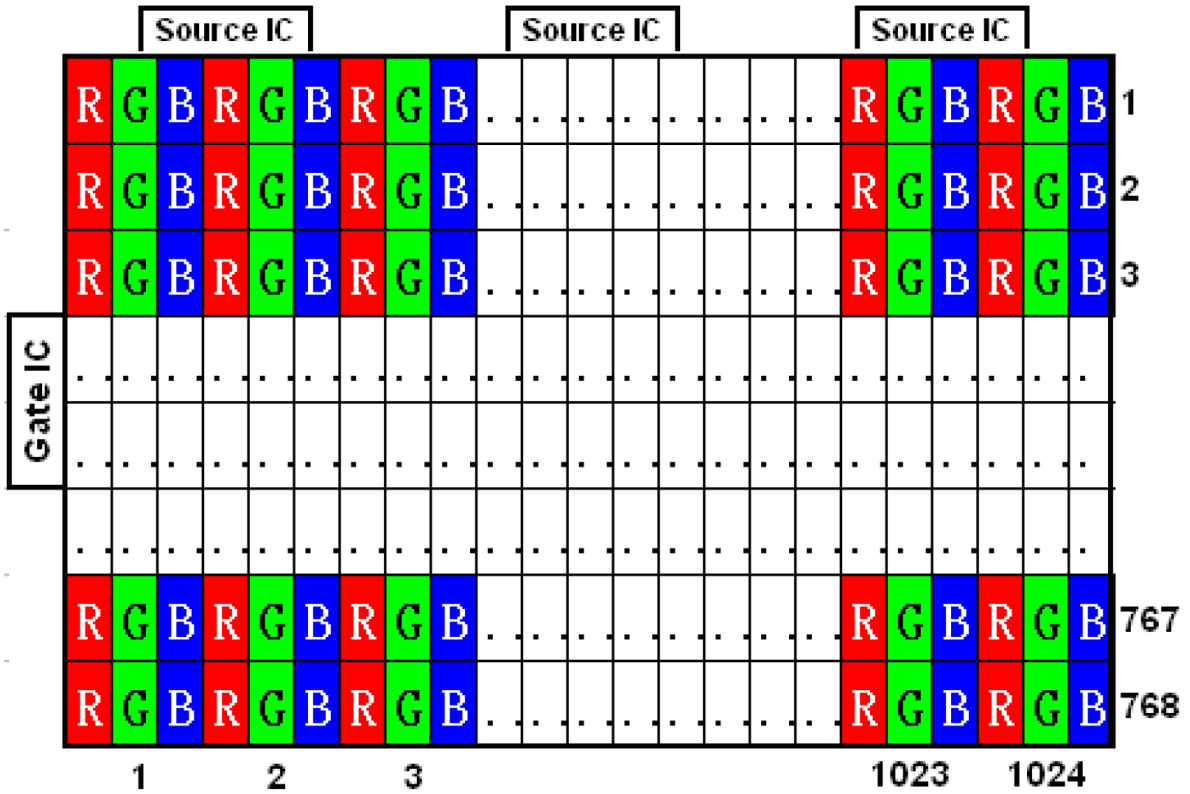

Fig 8: Pixel Format

### 3.7 POWER SEQUENCE

#### Power ON/OFF Sequence

VDD power on/off sequence is as follows. Signals from any system shall be Hi-resistance state or low level when VDD is off. Interface signals are also shown in the chart.

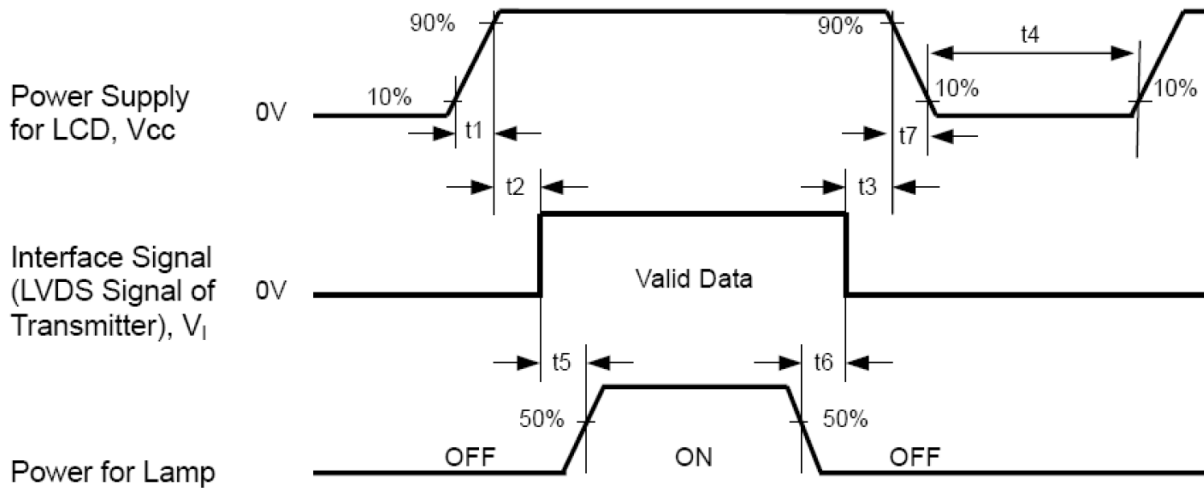

Fig 9: Power Sequencing

Table: Power ON/OFF sequence timing

Parameter	Symbol	Unit	min	Typ.	Max
VDD Rise Time	T1	ms	0.5	-	10
VDD Good to Signal Valid	T2	ms	0	-	20
Signal Disable to Power Down	T3	ms	0	-	1000
Power Off	T4	ms	1000	-	
Signal Valid to Backlight On	T5	ms	300	-	
Backlight Off to Signal Disable	T6	ms	200	-	
VDD Fall Time	T7	ms	0	-	100

## 4 OPTICAL SPECIFICATION

### 4.1 OPTICAL CHARACTERISTICS

Driving condition: IOVCC = VCI = 2.8V, VSS = 0V  
 Backlight: I\_LED=240 mA, V\_LED=12V, PWM\_LED: Duty 100%  
 Measured temperature: Ta = 25° C

Item	Symbol	Condition	MIN	TYP	MAX	Unit	Note	
Response Time	TR+TF	$\theta=\phi=0^\circ$ Normal Viewing Angle	-	16	-	ms	2	
Contrast Ratio	CR		450	800	-		3	
Viewing Angle	Left	CR $\geq$ 10	70	80	-	deg	4	
	Right		70	80	-	deg		
	Up		70	80	-	deg		
	Down		70	80	-	deg		
Colour Chromaticity	Red	Rx	CR $\geq$ 10	Typ.- 0.03	Typ.+0.0 3	-	5	
		Ry				-		
	Green	Gx				TBD		-
		Gy				TBD		-
	Blue	Bx				TBD		-
		By				TBD		-
	White	Wx		0.255	0.305	0.355		-
		Wy		0.275	0.325	0.375		-
Centre Brightness		centre	TBD	500	-	cd/m <sup>2</sup>	6	
Brightness Distribution		9 Points	75	80	-	%	7	

### Test Method

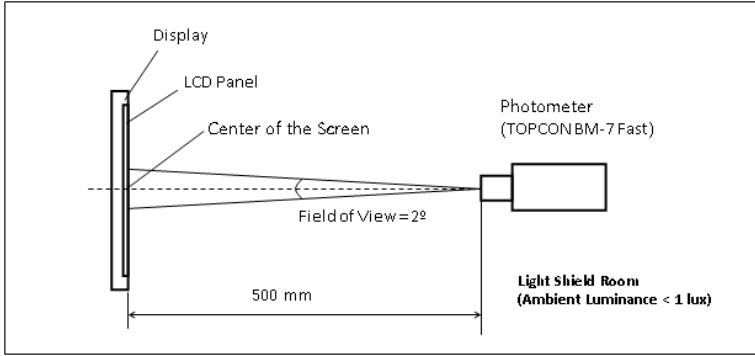
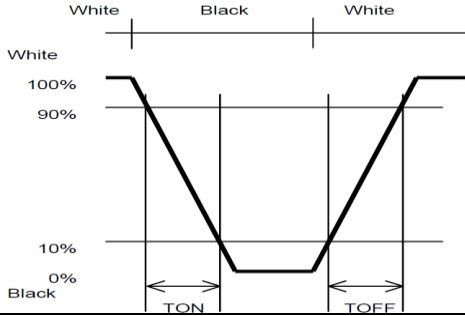
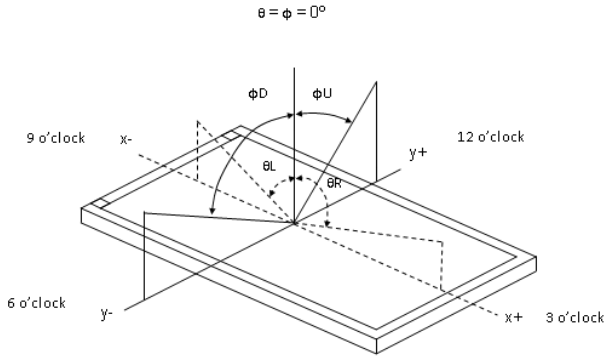
Note	Item	Test method
1	Setup	<p>The display should be stabilised at a given temperature for 30 minutes to avoid abrupt temperature change during measuring. In order to stabilise the luminance, measurements should be executed after lighting the backlight for 30 minutes in a windless room.</p> 
2	Response time	<p>Measure output signal waveform by the luminance meter when raster of window pattern is changed from white to black and from black to white.</p> 
3	Contrast ratio	<p>Measure maximum brightness and minimum brightness at the centre of the screen by displaying raster or window pattern. Then calculate the ratio between these two values.</p> $\text{Contrast Ratio (CR)} = \frac{\text{Brightness of unselected position (white)}}{\text{Brightness of selected position (black)}}$
4	Viewing angle Horizontal $\theta$ Vertical $\phi$	<p>Move the luminance meter from right to left and up and down and determinate the angles where contrast ratio is 10</p> 
5	Colour chromaticity	Measure chromaticity coordinates x and y of CIE1931 colorimetric system
6	Centre brightness	Measure the brightness at the centre of the screen
7	Brightness distribution	<p>(Brightness distribution)= 100 x B/A % A: max. brightness of the 9 points B: min. brightness of the 9 points</p>



## 5 BACKLIGHT SPECIFICATION

### 5.1 LED INTERFACE PIN ASSIGNMENT

Connector mode: MSB24038P5A or compatible

Manufactured: STM or compatible

Mating model number: P24038P5A or compatible

Pin#	Symbol	Signal Name
1	Vcc	12V
2	GND	GND
3	Enable	5V-On / 0V-Off
4	Dimming	PWM Dimming or Analog Dimming
5	NC	NC

### 5.2 PARAMETER GUIDELINE OF LED BACKLIGHT

Symbol	Parameter	Min.	Typ.	Max.	Units	Condition	
VLED	LED Input	10.8	12	12.6	V	Ta=25°C	
PLED	LED power consumption	-	-	(7.5)	W		
VLED_PWM	PWM signal voltage	High	4.5	5	5.5		V
		Low	-	-	0.8		
F <sub>PWM</sub>	PWM dimming Frequency	200	-	20K	Hz		
VLED_EN	LED Enable voltage	High	2.0	5	5.5		V
		Low	-	-	0.8		
LED Life Time	LED Life Time	(30,000)	-	-	Hours	Ta=25°C	

Note1: The LED life time define as the estimated time to 50% degradation of initial luminous.

Note2: Operating temperature 25°C, humidity 55% RH

Note3: A higher LED power supply voltage will result in better power efficiency. Keep the V\_LED between 12V and 12.6V is strongly recommended.

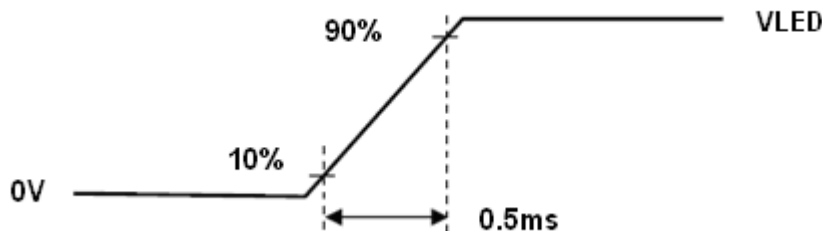

Fig10: LED Rush Current Measure Condition

## 6 QUALITY ASSURANCE SPECIFICATION

### 6.1 DELIVERY INSPECTION STANDARDS

#### Inspection Conditions

Inspection distance: 30 cm ± 2 cm  
Viewing angle: ±45°

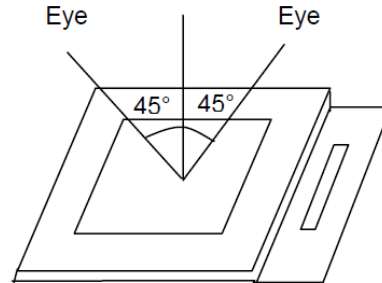

#### Environmental Conditions

Ambient temperature: 23°C ±5°C  
Ambient humidity: 55±10% RH  
Ambient illumination: 1000~1500 lux

#### Sampling Conditions

1. Lot size: quantity of shipment lot per model
2. Sampling method:

Sampling Plan		ANSI / ASQC Z1.4-1993
		Normal inspection, Single Sampling
AQL	Major Defect	0.65%
	Minor Defect	1.5%

#### Definition of Area

A zone: active area  
B zone: viewing area

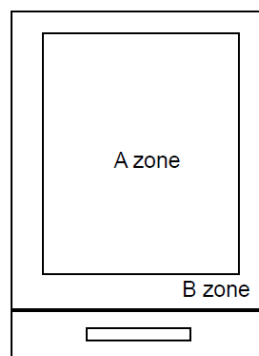

#### Basic Principle

A set of sample to indicate the limit of acceptable quality level shall be discussed should a dispute occur.

**Inspection Criteria**

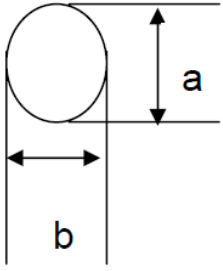
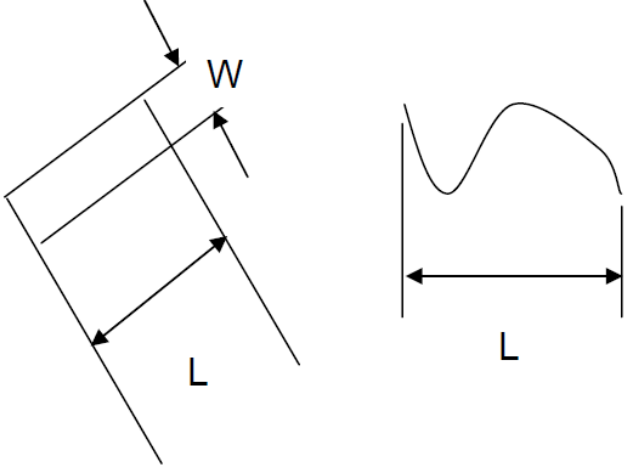
No.	Item	Criteria (Unit: mm)																		
01	Black / White spot Foreign material (Round type) Pinholes Stain Particles inside cell. (Minor defect)	 <table border="1" data-bbox="853 443 1380 801"> <thead> <tr> <th>Size</th> <th>Area</th> <th>Acc. Qty</th> </tr> </thead> <tbody> <tr> <td><math>\varphi \leq 0.10</math></td> <td></td> <td>Ignore</td> </tr> <tr> <td><math>0.10 &lt; \varphi \leq 0.15</math></td> <td></td> <td>2</td> </tr> <tr> <td><math>0.15 &lt; \varphi \leq 0.25</math></td> <td></td> <td>1</td> </tr> <tr> <td><math>0.25 &lt; \varphi</math></td> <td></td> <td>0</td> </tr> <tr> <td><b>Total</b></td> <td></td> <td>2 no include <math>\varphi \leq 0.10</math></td> </tr> </tbody> </table> <p><math>\varphi = (a + b) / 2</math></p> <p>Distance between 2 defects should more than 3mm apart.</p>	Size	Area	Acc. Qty	$\varphi \leq 0.10$		Ignore	$0.10 < \varphi \leq 0.15$		2	$0.15 < \varphi \leq 0.25$		1	$0.25 < \varphi$		0	<b>Total</b>		2 no include $\varphi \leq 0.10$
Size	Area	Acc. Qty																		
$\varphi \leq 0.10$		Ignore																		
$0.10 < \varphi \leq 0.15$		2																		
$0.15 < \varphi \leq 0.25$		1																		
$0.25 < \varphi$		0																		
<b>Total</b>		2 no include $\varphi \leq 0.10$																		
02	Black and White line Scratch Foreign material (Line type) (Minor defect)																			

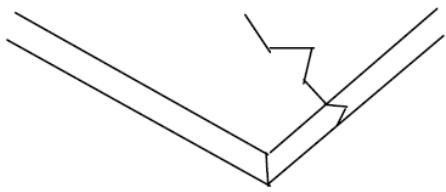
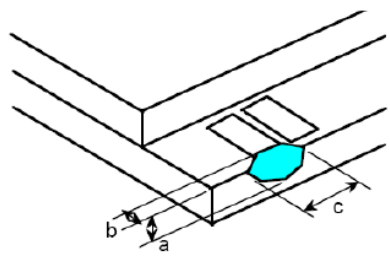
		<table border="1"> <thead> <tr> <th>Length</th> <th>Width</th> <th>Acc. Qty</th> </tr> </thead> <tbody> <tr> <td>/</td> <td><math>W \leq 0.03</math></td> <td>Ignore</td> </tr> <tr> <td><math>L \leq 2.5</math></td> <td><math>0.03 &lt; W \leq 0.05</math></td> <td>3</td> </tr> <tr> <td><math>L \leq 2.5</math></td> <td><math>0.05 &lt; W \leq 0.10</math></td> <td>2</td> </tr> <tr> <td>/</td> <td><math>0.1 &lt; W</math></td> <td>0</td> </tr> <tr> <td colspan="2">Total</td> <td>3</td> </tr> </tbody> </table> <p>Distance between 2 defects should more than 3mm apart. Scratches not viewable through the back of the display are acceptable.</p>	Length	Width	Acc. Qty	/	$W \leq 0.03$	Ignore	$L \leq 2.5$	$0.03 < W \leq 0.05$	3	$L \leq 2.5$	$0.05 < W \leq 0.10$	2	/	$0.1 < W$	0	Total		3
Length	Width	Acc. Qty																		
/	$W \leq 0.03$	Ignore																		
$L \leq 2.5$	$0.03 < W \leq 0.05$	3																		
$L \leq 2.5$	$0.05 < W \leq 0.10$	2																		
/	$0.1 < W$	0																		
Total		3																		
03	Glass Crack (Minor defect)	 <p>Crack is potential to enlarge, any type is not allowed.</p>																		
04	Glass Chipping Pad Area: (Minor defect)	 <table border="1"> <thead> <tr> <th>Length and Width</th> <th>Acc. Qty</th> </tr> </thead> <tbody> <tr> <td><math>c &gt; 3.0, b &lt; 1.0</math></td> <td>1</td> </tr> <tr> <td><math>c &lt; 3.0, b &lt; 1.0</math></td> <td>3</td> </tr> <tr> <td colspan="2"><math>a &lt; \text{Glass Thickness}</math></td> </tr> </tbody> </table>	Length and Width	Acc. Qty	$c > 3.0, b < 1.0$	1	$c < 3.0, b < 1.0$	3	$a < \text{Glass Thickness}$											
Length and Width	Acc. Qty																			
$c > 3.0, b < 1.0$	1																			
$c < 3.0, b < 1.0$	3																			
$a < \text{Glass Thickness}$																				

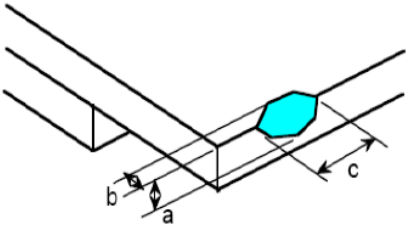
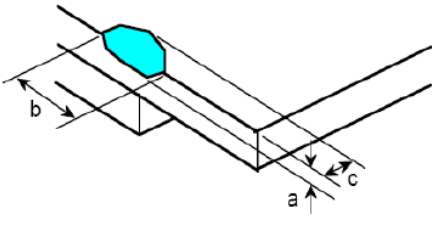
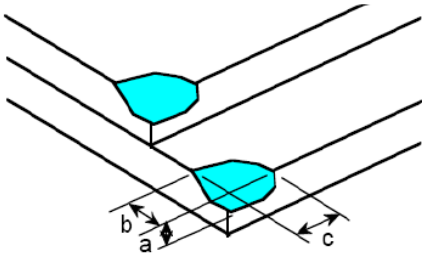
<p>05</p>	<p>Glass Chipping Rear of Pad Area: (Minor defect)</p> 	<table border="1"> <thead> <tr> <th>Length and Width</th> <th>Acc. Qty</th> </tr> </thead> <tbody> <tr> <td><math>c &gt; 3.0, b &lt; 1.0</math></td> <td>1</td> </tr> <tr> <td><math>c &lt; 3.0, b &lt; 1.0</math></td> <td>2</td> </tr> <tr> <td><math>c &lt; 3.0, b &lt; 0.5</math></td> <td>4</td> </tr> <tr> <td colspan="2" style="text-align: center;"><math>a &lt; \text{Glass Thickness}</math></td> </tr> </tbody> </table>	Length and Width	Acc. Qty	$c > 3.0, b < 1.0$	1	$c < 3.0, b < 1.0$	2	$c < 3.0, b < 0.5$	4	$a < \text{Glass Thickness}$	
Length and Width	Acc. Qty											
$c > 3.0, b < 1.0$	1											
$c < 3.0, b < 1.0$	2											
$c < 3.0, b < 0.5$	4											
$a < \text{Glass Thickness}$												
<p>06</p>	<p>Glass Chipping Except Pad Area: (Minor defect)</p> 	<table border="1"> <thead> <tr> <th>Length and Width</th> <th>Acc. Qty</th> </tr> </thead> <tbody> <tr> <td><math>c &gt; 3.0, b &lt; 1.0</math></td> <td>1</td> </tr> <tr> <td><math>c &lt; 3.0, b &lt; 1.0</math></td> <td>2</td> </tr> <tr> <td><math>c &lt; 3.0, b &lt; 0.5</math></td> <td>4</td> </tr> <tr> <td colspan="2" style="text-align: center;"><math>a &lt; \text{Glass Thickness}</math></td> </tr> </tbody> </table>	Length and Width	Acc. Qty	$c > 3.0, b < 1.0$	1	$c < 3.0, b < 1.0$	2	$c < 3.0, b < 0.5$	4	$a < \text{Glass Thickness}$	
Length and Width	Acc. Qty											
$c > 3.0, b < 1.0$	1											
$c < 3.0, b < 1.0$	2											
$c < 3.0, b < 0.5$	4											
$a < \text{Glass Thickness}$												
<p>07</p>	<p>Glass Corner Chipping: (Minor defect)</p> 	<table border="1"> <thead> <tr> <th>Length and Width</th> <th>Acc. Qty</th> </tr> </thead> <tbody> <tr> <td><math>c &lt; 3.0, b &lt; 3.0</math></td> <td>Ignore</td> </tr> <tr> <td colspan="2" style="text-align: center;"><math>a &lt; \text{Glass Thickness}</math></td> </tr> </tbody> </table>	Length and Width	Acc. Qty	$c < 3.0, b < 3.0$	Ignore	$a < \text{Glass Thickness}$					
Length and Width	Acc. Qty											
$c < 3.0, b < 3.0$	Ignore											
$a < \text{Glass Thickness}$												

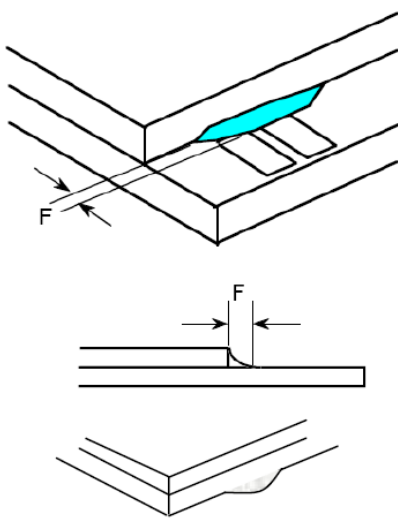
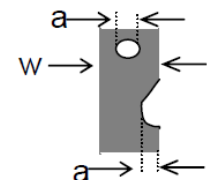
08	<p>Glass Burr: (Minor defect)</p> 	<table border="1" data-bbox="837 555 1305 645"> <thead> <tr> <th>Length</th> <th>Acc. Qty</th> </tr> </thead> <tbody> <tr> <td><math>F &lt; 1.0</math></td> <td>Ignore</td> </tr> </tbody> </table> <p>Glass burr don't affect assemble and module dimension.</p>	Length	Acc. Qty	$F < 1.0$	Ignore				
Length	Acc. Qty									
$F < 1.0$	Ignore									
09	<p>FPC Defect: (Minor defect)</p> 	<p>9.1 Dent, pinhole width <math>a &lt; w/3</math>. (<math>w</math>: circuitry width.)</p> <p>9.2 Open circuit is unacceptable.</p> <p>9.3 No oxidation, contamination and distortion.</p>								
10	<p>Bubble on Polarizer (Minor defect)</p>	<table border="1" data-bbox="715 1438 1182 1610"> <thead> <tr> <th>Diameter</th> <th>Acc. Qty</th> </tr> </thead> <tbody> <tr> <td><math>\varphi \leq 0.20</math></td> <td>Ignore</td> </tr> <tr> <td><math>0.20 &lt; \varphi \leq 0.30</math></td> <td>4</td> </tr> <tr> <td><math>0.30 &lt; \varphi</math></td> <td>None</td> </tr> </tbody> </table>	Diameter	Acc. Qty	$\varphi \leq 0.20$	Ignore	$0.20 < \varphi \leq 0.30$	4	$0.30 < \varphi$	None
Diameter	Acc. Qty									
$\varphi \leq 0.20$	Ignore									
$0.20 < \varphi \leq 0.30$	4									
$0.30 < \varphi$	None									
11	<p>Dent on Polarizer (Minor defect)</p>	<table border="1" data-bbox="715 1680 1182 1852"> <thead> <tr> <th>Diameter</th> <th>Acc. Qty</th> </tr> </thead> <tbody> <tr> <td><math>\varphi \leq 0.20</math></td> <td>Ignore</td> </tr> <tr> <td><math>0.20 &lt; \varphi \leq 0.30</math></td> <td>4</td> </tr> <tr> <td><math>0.30 &lt; \varphi</math></td> <td>None</td> </tr> </tbody> </table>	Diameter	Acc. Qty	$\varphi \leq 0.20$	Ignore	$0.20 < \varphi \leq 0.30$	4	$0.30 < \varphi$	None
Diameter	Acc. Qty									
$\varphi \leq 0.20$	Ignore									
$0.20 < \varphi \leq 0.30$	4									
$0.30 < \varphi$	None									
12	<p>Bezel</p>	<p>12.1 No rust, distortion on the Bezel.</p> <p>12.2 No visible fingerprints, stains or other contamination.</p>								

13	Touch Panel	<p>D: Diameter W: width L: length</p> <p>13.1 Spot: <math>D &lt; 0.25</math> is acceptable <math>0.25 \leq D \leq 0.4</math></p> <p>2dots are acceptable and the distance between defects should more than 10 mm. <math>D &gt; 0.4</math> is unacceptable</p> <p>13.2 Dent: <math>D &gt; 0.40</math> is unacceptable</p> <p>13.3 Scratch: <math>W \leq 0.03</math>, <math>L \leq 10</math> is acceptable, <math>0.03 &lt; W \leq 0.10</math>, <math>L \leq 10</math> is acceptable</p> <p>Distance between 2 defects should more than 10 mm. <math>W &gt; 0.10</math> is unacceptable.</p>
14	PCB	<p>14.1 No distortion or contamination on PCB terminals.</p> <p>14.2 All components on PCB must same as documented on the BOM/component layout.</p> <p>14.3 Follow IPC-A-600F.</p>
15	Soldering	Follow IPC-A-610C standard
16	Electrical Defect (Major defect)	<p>The below defects must be rejected.</p> <p>16.1 Missing vertical / horizontal segment,</p> <p>16.2 Abnormal Display.</p> <p>16.3 No function or no display.</p> <p>16.4 Current exceeds product specifications.</p> <p>16.5 LCD viewing angle defect.</p> <p>16.6 No Backlight.</p> <p>16.7 Dark Backlight.</p> <p>16.8 Touch Panel no function.</p> <p>16.9 Dark Dot –one Allowed.</p> <p>16.10 Bright Dot – one Allowed.</p> <p>Remark:</p> <p>1. A pixel defect is acceptable if one color is none functional and causes a bright dot. The display may have one case where one color is out and cause a dark dot.</p> <p>2. Bright dot caused by scratch and foreign object accords to item 1.</p>

Remark: LCD Panel Broken shall be rejected. Defect out of LCD viewing area is acceptable.

### **Classification of Defects**

Visual defects (except no or wrong label) are treated as minor defects, while electrical defects are treated as major defects.

Two minor defects are equal to one major defect in lot sampling inspection.

### **Identification / marking criteria**

Any unit with illegible / wrong / double or no marking / label shall be rejected.

## **6.2 DEALING WITH CUSTOMER COMPLAINTS**

---

### **Non-conforming analysis**

Purchaser should supply Densitron with detailed data of non-conforming sample.

After accepting it, Densitron should complete the analysis in two weeks from receiving the sample.

If the analysis cannot be completed on time, Densitron must inform the purchaser.

### **Handling of non-conforming displays**

If any non-conforming displays are found during customer acceptance inspection which Densitron is clearly responsible for, return them to Densitron.

Both Densitron and customer should analyse the reason and discuss the handling of non-conforming displays when the reason is not clear.

Equally, both sides should discuss and come to agreement for issues pertaining to modification of Densitron quality assurance standard.



## 7 RELIABILITY SPECIFICATION

### 7.1 RELIABILITY TESTS

Test Item		Test Condition
Durability Test	High Temperature Storage	Ta= 80°C 96h
	Low Temperature Storage	Ta=-30°C 96h
	Temperature Cycle Storage	-20°C for 30 min, then 70°C for 30 min, 20 cycles
	High Temperature Operation	Tp= 70°C 96h
	Low Temperature Operation	Tp= -20°C 96h
	High Temperature & Humidity Operation	Tp= 40°C RH= 90% 96h Non condensing
	Thermal Shock Resistance	The sample should be allowed to stand the following 5 cycles of operation: TSTL for 30 minutes -> normal temperature for 5 minutes -> TSTH for 30 minutes -> normal temperature for 5 minutes, as one cycle, then taking it out and drying it at normal temperature, and allowing it stand for 24 hours

Note: Ta=ambient temperature Tp= Panel temperature

Notes:

1. No dew condensation to be observed.
2. The function test shall be conducted after 4 hours storage at the normal temperature and humidity after removed from the test chamber.
3. No cosmetic or functional defects should be allowed.
4. Total current consumption should be less than twice the initial value.

## 8 HANDLING PRECAUTIONS

### **Safety**

If the LCD panel breaks, be careful not to get the liquid crystal fluid in your mouth or in your eyes. If the liquid crystal touches your skin or clothes, wash it off immediately using soap and plenty of water.

### **Mounting and Design**

Place a transparent plate (e.g. acrylic, polycarbonate or glass) on the display surface to protect the display from external pressure. Leave a small gap between the transparent plate and the display surface.

When assembling with a zebra connector, clean the surface of the pads with alcohol and keep the surrounding air very clean.

Design the system so that no input signal is given unless the power supply voltage is applied.

### **Caution during LCD cleaning**

Lightly wipe the display surface with a soft cloth soaked with Isopropyl alcohol, Ethyl alcohol or Trichlorotrifluoroethane.

Do not wipe the display surface with dry or hard materials that will damage the polariser surface. Do not use aromatic solvents (toluene and xylene), or ketonic solvents (ketone and acetone).

### **Caution against static charge**

As the display uses C-MOS LSI drivers, connect any unused input terminal to VDD or VSS. Do not input any signals before power is turned on. Also, ground your body, work/assembly table and assembly equipment to protect against static electricity.

### **Packaging**

Displays use LCD elements, and must be treated as such. Avoid strong shock and drop from a height. To prevent displays from degradation, do not operate or store them exposed directly to sunshine or high temperature/humidity.

### **Caution during operation**

It is indispensable to drive the display within the specified voltage limit since excessive voltage shortens its life. Direct current causes an electrochemical reaction with remarkable deterioration of the display quality. Give careful consideration to prevent direct current during ON/OFF timing and during operation. Response time is extremely delayed at temperatures lower than the operating temperature range while, at high temperatures, displays become dark. However, this phenomenon is reversible and does not mean a malfunction or a display that has been permanently damaged. If the display area is pushed on hard during operation, some graphics will be abnormally displayed but returns to a normal condition after turning off the display once. Even a small amount of condensation on the contact pads (terminals) can cause an electro-chemical reaction which causes missing rows and columns. Give careful attention to avoid condensation.

### **Storage**

Store the display in a dark place where the temperature is 25°C ± 10°C and the humidity below 50%RH. Store the display in a clean environment, free from dust, organic solvents and corrosive gases.

Do not crash, shake or jolt the display (including accessories).

Product No.	DET150XGNLNTOM-1A	REV. 1.0
-------------	-------------------	----------

Page	26 / 26
------	---------