

5 WIRE RESISITIVE TOUCH PANEL

Product Specification

CUSTOMER	
PRODUCT NUMBER	DTS416-0840-0F Series

INTERNAL APPROVALS		
Product Manager	Engineering	Document Control

TABLE OF CONTENTS

1	MAIN FEATURES	4
2	MECHANICAL DRAWING	5
3	OPTICAL CHARACTERISTICS	6
4	ELECTRICAL CHARACTERISTICS	6
5	MECHANICAL CHARACTERISTICS	7
6	RELIABILITY	7
7	DURABILITY	7
8	INSPECTION METHODS.....	8
9	APPEARANCE INSPECTION	9
10	ATTENTION FOR MOUNTING	10
11	PART NUMBER DESCRIPTION FOR AVAILABLE OPTIONS	11
12	HANDLING PRECAUTIONS	11

REVISION RECORD

Rev.	Date	Page	Par.	Comment	ECN no.
A	07/23/10	--	--	Initial DCA Release	E4333

1 MAIN FEATURES

ITEM	CONTENTS	UNIT
Type	Five-Wire Analog Resistive	--
Input Mode	Stylus or Finger	--
Construction	Glass-Film-Glass	--
Frame Size	186.9 ± 0.30 (W) x 142.3 ± 0.30 (H) x 2.5 ± 0.30 (D)	mm
Top Glass Area	179.6 ± 0.30 (W) x 139.3 ± 0.30 (H)	
Viewing Area	173.8 ± 0.20 (W) x 131.2 ± 0.20 (H)	mm
Active Area	171.4 ± 0.20 (W) x 128.8 ± 0.20 (H)	mm
Tail Length	155.00 ± 6.00	mm
Operation Temperature	-10 ~ +70 (20% RH ~ 90% RH) (note 1.1)	°C
Storage Temperature	-40 ~ +80 (10% RH ~ 90% RH) (note 1.1)	°C
RoHS Compliant	Yes	--

Note 1.1: All terms under 1 atmosphere:

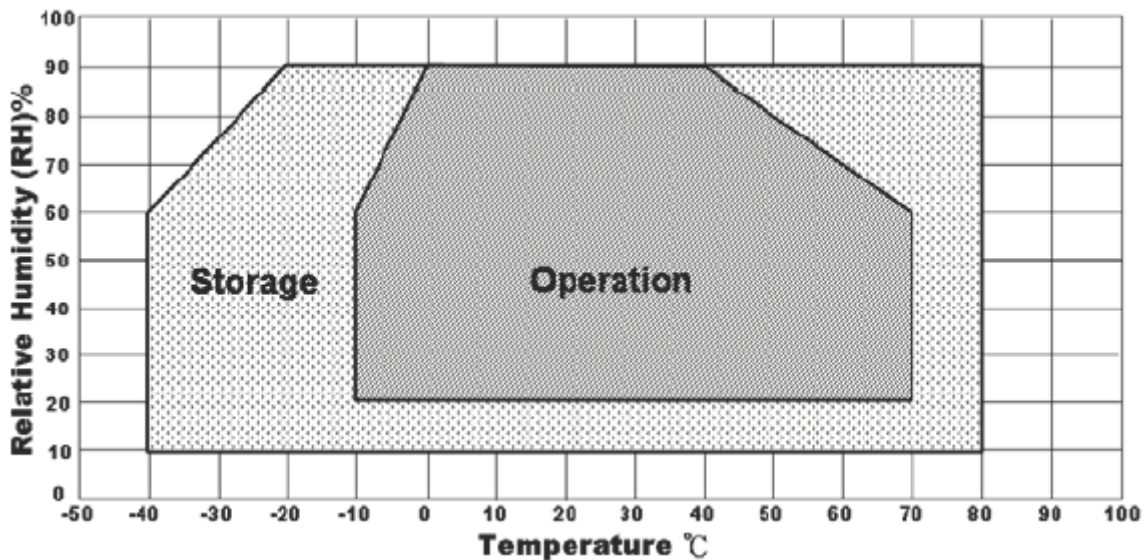

2 MECHANICAL DRAWING

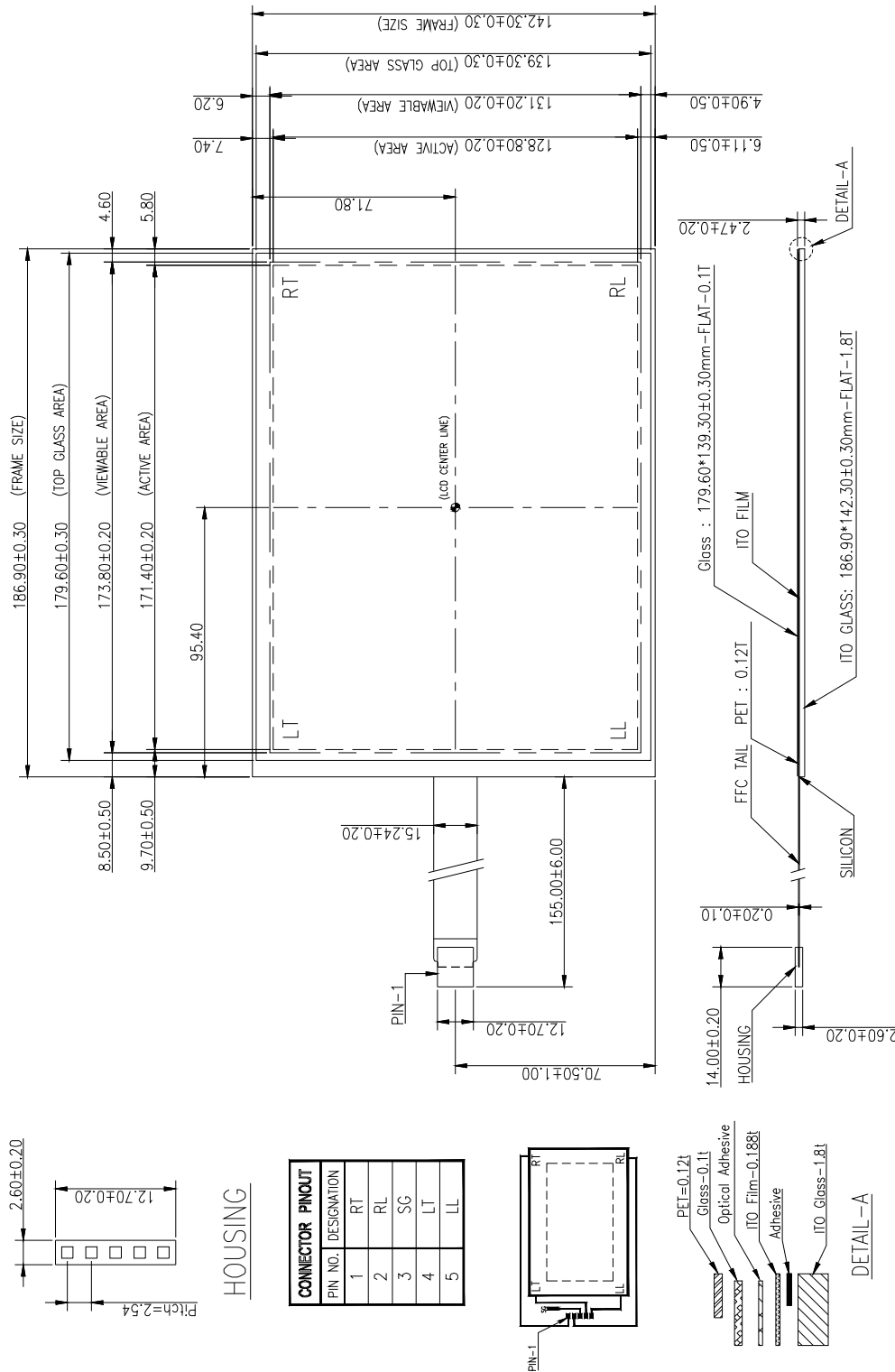

Recommended touch decoder kit:
 Controller: TSC400-12E-000 (USB)
 TSC600-02E-000 (RS-232)
 Cable: TSC-2P30-000 (Pin to Pin Cable)
 TSCC-1E-000 (USB External Cable)
 TSCC-0E-000 (RS-232 External Cable)

Recommended Mating Connector:
 Molex 0015912055
 Molex 0022052051

3 OPTICAL CHARACTERISTICS

Item	Specifications
Transparency	80% ± 3% (clear type measured by BYK-Gardner at 550nm)
Haze	4.5% ± 3%

4 ELECTRICAL CHARACTERISTICS

Item	Specifications
Loop Resistance	X: 20 ~ 500Ω, Y: 20 ~ 500Ω (see note 4.1)
Linearity	$X \leq 1.5\%$, $Y \leq 1.5\%$ (see note 8.1)
Chattering	≤ 15ms
Insulation	≥ 20MΩ / 25V (DC)
Endurance	No acting damage at DC 50V / 60 sec.

Note 4.1:

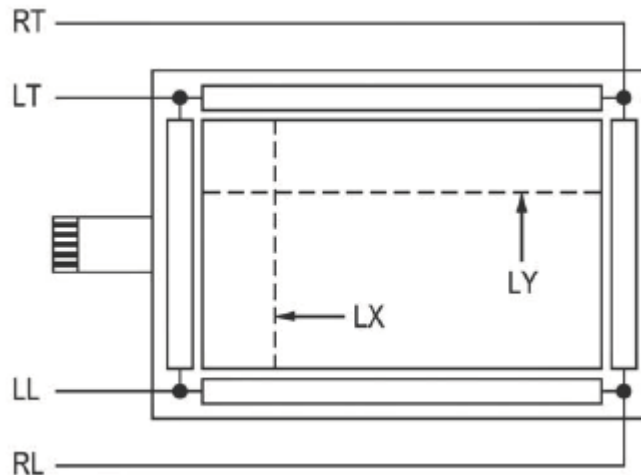

Loop Resistance X = short RT and RL, short LT and LL,
measure the resistance between RT and LT
Loop Resistance Y = short RT and LT, short RL and LL,
measure the resistance between RT and RL

5 MECHANICAL CHARACTERISTICS

Item		Specifications	Condition
Panel	Operating Force	Stylus = R 0.8	≤ 100g
	Impact	25.0 Dia. Steel Ball / 67g Height = 100 cm	1 time, no damage [Impact at center point].
	Static Load	5kg within 10 cm ² area for 30 sec.	Satisfy (1) of item 7 and (1), (2), (4) of item 6.
	Hardness	7 H pencil, pressure 750g / 45°	≥ 7 H
FFC	Peeling	800g by vertical 90°	Satisfy (1) of item 6.
	Bending	90° 10 times Up & Down	Satisfy (1) of item 6.

6 RELIABILITY

Item		Specifications	Condition
Panel	High Temp./ Humidity	70°C/ 90% RH, 240 hrs, allow panel to stay in normal environment for 4 hrs.	Reliability test may cause the film puffed yet the electric characteristics stay intact. (1), (2) of item 5; (1), (4) of item 6; (2) of item 6 satisfies X ≤ 2.5%, Y ≤ 3.0%.
	High Temp.	70°C/ 240 hrs allow panel to stay in normal environment for 4 hrs.	
	Low Temp.	-40°C/ 1000 hrs allow panel to stay in normal environment for 4 hrs.	
	Thermal Cycle	-40°C ~ 70°C [60 min./cycle] x 100 cycles. Allow panel to stay in normal environment for 4 hrs.	

7 DURABILITY

Item		Specifications	Condition
Panel	Knock Test	10,000,000 times	Satisfy (1), (2) of item 5; (1), (4) of item 6; (2) of item 6 satisfies. X ≤ 2.5%, Y ≤ 3.0%

8 INSPECTION METHODS

(1). Linearity

Step 1: Short RT and RL (or short RL and LL).

Step 2: Apply voltage DC 5V.

Step 3: Short LT and LL (or short RT and LT).

Step 4: Apply grounding.

Step 5: Draw points along Lx and Ly at 5.0 mm intervals within pattern area and detect the voltage at SG.

Step 6: Measure the voltage differences between RT and LT (or RT and RL) (see note 8.1 & 8.2)

Note 8.1:

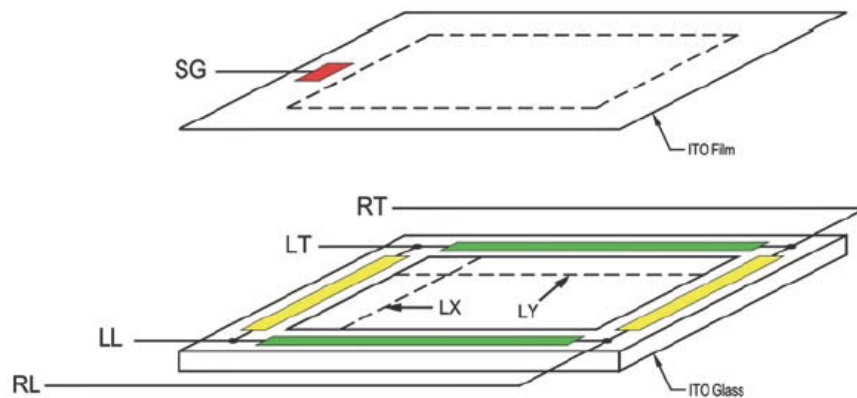

Note 8.2:

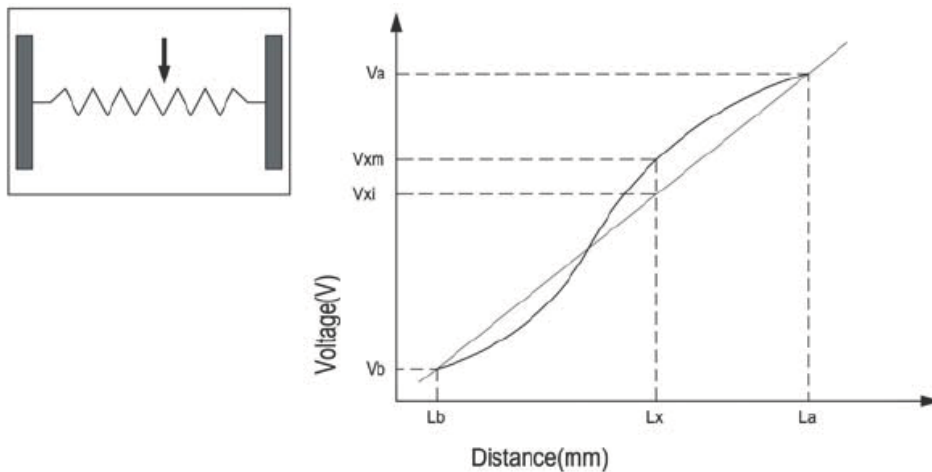

$$\text{Linearity: } [V_{xm} - V_{xi}] / (V_a - V_b) \times 100\%$$

(2) Specification

Linearity must meet the electrical characteristics specified in item 6.

Product No.	DTS416-0840-0F Series	REV. A
-------------	-----------------------	--------

Page	8 / 11
------	--------

9 APPEARANCE INSPECTION

(1) A 17W fluorescent luminant lamp is used for appearance inspection. Detail settings are shown in notes 9.1 & 9.2.

Note 9.1:

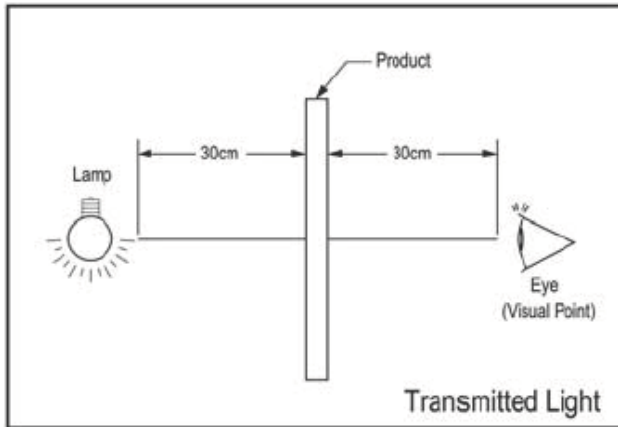

Note 9.2:

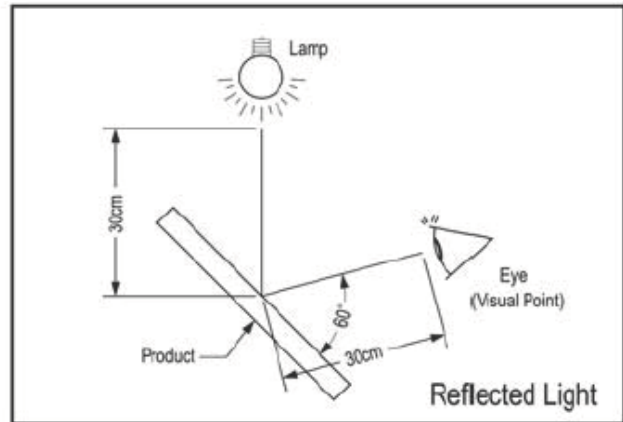

(2) Minor impurities outside viewing area are acceptable unless their existence affect electrical functions.

(3) Glass Flaw:

Item	Picture	Specification
Corner Flaw		$X \leq 3.0 \text{ mm}$ $Y \leq 3.0 \text{ mm}$ $Z \leq T$
Edge Flaw		$X \leq 3.0 \text{ mm}$ $Y \leq 3.0 \text{ mm}$ $Z \leq T$
Progressive Flaw		Not allowed

Note: T = Glass thickness

10 ATTENTION FOR MOUNTING

(1) The gasket support of touch panel must allocate outside of viewable area. Reserve enough clearance between panel surface and enclosure for normal panel operation.

To avoid pressing error, please retain enough space between surface panel and Bezel.

(2) Bezel opening must not touch Viewable Area, Bezel opening must be designed between Viewable Area and Active Area.

(3) We recommend elastic material support.

(4) Due to the conductive characteristic of the panel backside, prevent metal contact after mounting.

(5) Proper grounding of controller at all times assure normal operation.

Note 10.1:

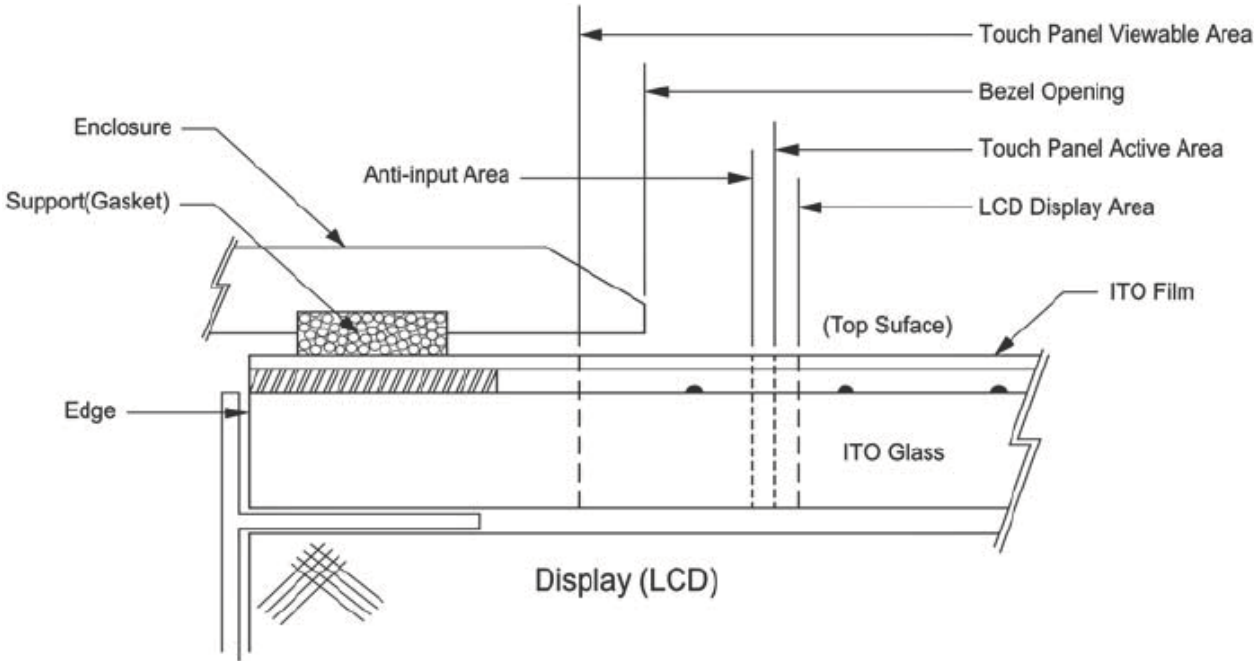

11 PART NUMBER DESCRIPTION FOR AVAILABLE OPTIONS

DTS416-0840-0F①-000

① **Surface Treatment Type**
 X= Clear
 G = Antiglare Finish

12 HANDLING PRECAUTIONS

Storage	Store panel under the temperature and humidity range pre-specified. Direct sunlight exposure or piling should be avoided.
Unpack	Unpack the box with the printed red arrow pointing up.
Handling	(1) Use clean sacks or glove to prevent fingerprints and/or stains left on the panel. Extra attention and carefulness should be taken while handling the glass edge. (2) Avoid touching the viewing area before installation /integration. (3) Holding the panel instead of the tail at all time.
Cleaning	(1) Use neutral detergent or isopropyl alcohol on a clean soft cloth to clean the panel surface. (2) Prevent using any kind of chemical solvent, acidic or alkali solution.
Installing and Assembling	(1) Excessive force or strain to the panel or tail is prohibited. (2) Retain at least 0.3 mm clearance between panel and display module. (3) Gasket or cushion pads around the edge of the panel may segregate water and/or dust contamination.
Operating	(1) Touch the panel with your finger or stylus only to assure normal operation. Any sharp edged or hard objects are prohibited. (2) Operate the panel in a steady environment. Abrupt variation on temperature and humidity may cause malfunction of the panel.
Others	(1) Keep the panel surface clean. Prevent any kind of adhesive applied on the surface. (2) Avoid high voltage and/or static charge.