

# LIQUID CRYSTAL DISPLAY MODULE

## Standard Product Specification

<b>PRODUCT NUMBER</b>	<b>LR4434</b>
-----------------------	---------------

INTERNAL APPROVALS		
Product Manager	Engineering	Document Control
Date:	Date:	Date:

## TABLE OF CONTENTS

<b>1</b>	<b>MAIN FEATURES.....</b>	<b>4</b>
<b>2</b>	<b>MECHANICAL SPECIFICATION.....</b>	<b>5</b>
2.1	MECHANICAL CHARACTERISTICS.....	5
2.2	LABELLING & MARKING.....	5
2.3	MECHANICAL DRAWING.....	6
<b>3</b>	<b>ELECTRICAL SPECIFICATION.....</b>	<b>7</b>
3.1	ABSOLUTE MAXIMUM RATINGS.....	7
3.2	ELECTRICAL CHARACTERISTICS.....	7
3.3	RECOMMENDED LC DRIVE VOLTAGE (Vo-Vss).....	7
3.4	INTERFACE PIN ASSIGNMENT.....	8
3.5	BLOCK DIAGRAM.....	9
3.6	POWER SUPPLY CIRCUIT.....	9
3.7	TIMING CHARACTERISTICS.....	9
<b>4</b>	<b>OPTICAL SPECIFICATION.....</b>	<b>10</b>
4.1	OPTICAL CHARACTERISTICS.....	10
<b>5</b>	<b>BACKLIGHT SPECIFICATION.....</b>	<b>12</b>
5.1	BACKLIGHT CHARACTERISTICS.....	12
<b>6</b>	<b>QUALITY ASSURANCE SPECIFICATION.....</b>	<b>13</b>
6.1	CONFORMITY.....	13
6.2	DELIVERY ASSURANCE.....	13
<b>7</b>	<b>RELIABILITY SPECIFICATION.....</b>	<b>17</b>
7.1	RELIABILITY TESTS.....	17
7.2	LIFE TIME.....	17
<b>8</b>	<b>PART NUMBER DESCRIPTIONS FOR AVAILABLE OPTIONS.....</b>	<b>18</b>
<b>9</b>	<b>HANDLING PRECAUTIONS.....</b>	<b>19</b>

**REVISION RECORD**

Rev.	Date	Page	Chap.	Comment	ECN no.
A	07/07/09	--	--	Initial DCA Release, ROHS	E4128

## 1 MAIN FEATURES

ITEM		CONTENTS	REMARK
Display Format		4 Line x 20 Characters	
Colour		Monochrome	
Overall Dimensions		98.8 (W) x 60.2 (H) x 12.8 Max. (D)	
Viewing Area		76.0 (W) x 25.5 (H)	
LCD Type		STN	
Mode		Transflective / Positive Transmissive / Negative	
Viewing Angle		6 o'clock	
Duty Ratio		1/16	
Driver IC/Controller		ST7066	
Backlight Type		LED	
Backlight Colour		Yellow-Green	
DC/DC Converter		Built-In	
Operating Temperature	Normal	0°C ~ +50°C	Note 1
	Wide	-20°C ~ +70°C	
Storage Temperature	Normal	-20°C ~ +70°C	Note 2
	Wide	-30°C ~ +80°C	
ROHS Compliant		Yes	

Note 1: Background colour changes slightly depending on ambient temperature. This phenomenon is reversible.

Ta ≤ 70°C: 75% RH max.

Ta > 70°C: absolute humidity must be lower than the humidity of 75%RH at 70°C

Note 2: Ta -30°C will be <48hrs, at 80°C will be <120hrs.

Product No.	LR4434	REV. A
-------------	--------	--------

Page	4 / 19
------	--------

## 2 MECHANICAL SPECIFICATION

### 2.1 MECHANICAL CHARACTERISTICS

---

ITEM	CHARACTERISTIC	UNIT
Display Format	4 Line x 20 Characters	--
Character Font Format	5 (W) x 7 (H) with attached cursor	--
Overall Dimensions	98.8 (W) x 60.2 (H) x 12.8 Max. (D)	mm
Viewing Area	76.0 (W) x 25.5 (H)	mm
Active Area	70.4 (W) x 20.8 (H)	mm
Dot Size	0.55 (W) x 0.55 (H)	mm
Dot Pitch	0.60 (W) x 0.60 (H)	mm
IC Controller/Driver	ST7066	

### 2.2 LABELLING & MARKING

---

DENSITRON LR4434 TAIWAN YYMM
------------------------------------

2.3 MECHANICAL DRAWING

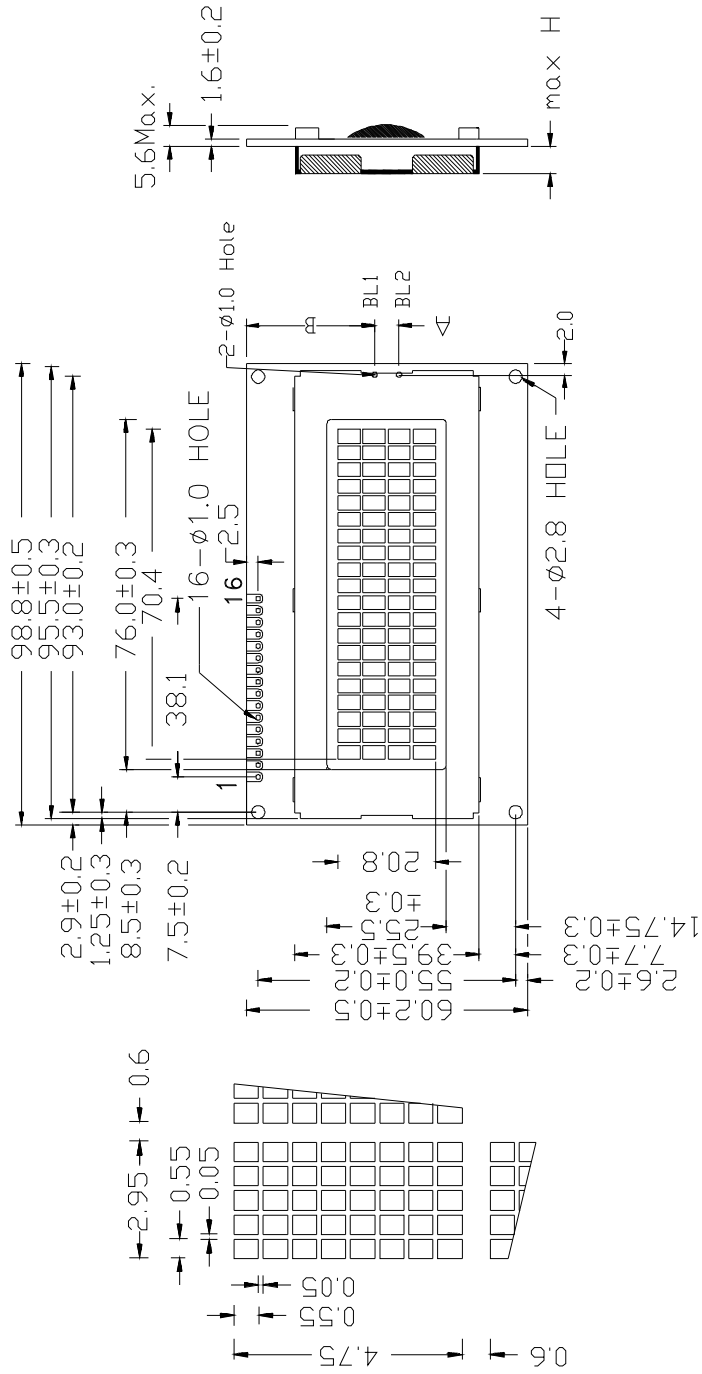

MODULE	H	A	B
LED EDGE	7.2	7.62	27.56

UNIT:mm

### 3 ELECTRICAL SPECIFICATION

#### 3.1 ABSOLUTE MAXIMUM RATINGS

VSS = 0 V, Ta = 25 °C

Item	Symbol	Min	Max	Unit	Note
Power Supply Voltage	V <sub>DD</sub> -V <sub>SS</sub>	0	6	V	
Input voltage	V <sub>in</sub>	0	V <sub>dd</sub>	V	
LCD driving Voltage	V <sub>dd</sub> -V <sub>o</sub>	4	10	V	
Static Electricity	Be sure that you are grounded when handling displays.				

#### 3.2 ELECTRICAL CHARACTERISTICS

VSS = 0 V, Ta = 25 °C

Item	Symbol	Condition	Min	Typ	Max	Unit
Power Supply for Logic	V <sub>DD</sub> -V <sub>SS</sub>	Ta = 25°C	4.5	5.0	5.5	V
Input Voltage	V <sub>IH</sub>	Ta = 25°C	2.4	--	V <sub>DD</sub>	V
	V <sub>IL</sub>	Ta = 25°C	--	--	1.0	V
Current Consumption	* I <sub>DD</sub>	V <sub>DD</sub> = 5.0V	--	3	--	mA

- I<sub>DD</sub> measurement condition is for all pattern ON

#### 3.3 RECOMMENDED LC DRIVE VOLTAGE (V<sub>o</sub>-V<sub>SS</sub>)

Temperature	STN	STN-H
Ta= -20°C	--	4.5
Ta= 0°C	4.4	4.4
Ta= 25°C	4.4	4.4
Ta= 50°C	4.4	4.4
Ta= 70°C	--	4.3

### 3.4 INTERFACE PIN ASSIGNMENT

Pin No.	Symbol	Level	Description
1	V <sub>SS/LED(-)</sub>	--	Ground (0V) and Cathode of LED B/L
2	V <sub>DD</sub>	--	Logic Supply Voltage (+5V)
3	V <sub>O</sub>	--	LC Drive voltage for contrast adjustment
4	RS	I	Register Select 0: Instruction Register 1: Data Register
5	R/W	I	Read / Write 0: Data Write (Module ← MPU) 1: Data Read (Module → MPU)
6	E	I	Enable Signal Active High (H→L)
7	DB0	I/O	Bi-directional data bus line 0
8	DB1	I/O	Bi-directional data bus line 1
9	DB2	I/O	Bi-directional data bus line 2
10	DB3	I/O	Bi-directional data bus line 3
11	DB4	I/O	Bi-directional data bus line 4
12	DB5	I/O	Bi-directional data bus line 5
13	DB6	I/O	Bi-directional data bus line 6
14	DB7	I/O	Bi-directional data bus line 7
15	BL1	--	Anode of LED B/L, V <sub>LED+</sub>
16	BL2	--	Cathode of LED B/L. V <sub>LED-</sub>
BL1	VLED+	--	Anode (+): LED backlight input voltage
BL2	VLED-	--	Cathode (-): LED backlight input voltage



### 3.5 BLOCK DIAGRAM

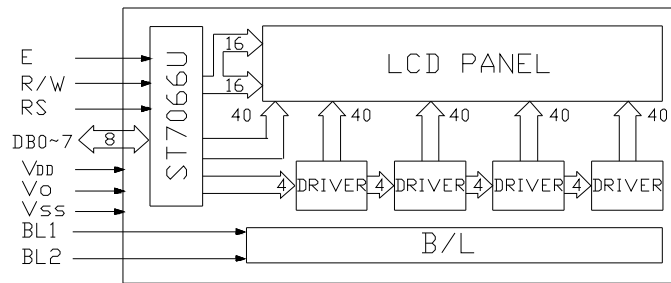

### 3.6 POWER SUPPLY CIRCUIT

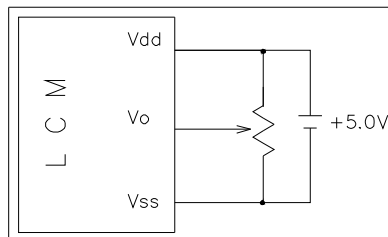

RECOMMENDED R : 10 K ohm ~ 20 K ohm

### 3.7 TIMING CHARACTERISTICS

Please reference the manufacture's specifications for the ST7066 controller.

Product No.	LR4434	REV. A
-------------	--------	--------

Page	9 / 19
------	--------

## 4 OPTICAL SPECIFICATION

### 4.1 OPTICAL CHARACTERISTICS

Ta = 25 °C

Item		Symbol	Condition	Min	Typ	Max	Unit	Note
Viewing Angle		θ1	CR≥2	--	45	--	deg	1
		θ2	CR≥2	--	35	--	deg	1
		θ3	CR≥2	--	35	--	deg	2
		θ4	CR≥2	--	35	--	deg	2
Contrast Ratio	STN	CR	Ta = 25°C	--	7.0	--	--	3
Response Time		Tr	Ta = 25°C	--	60	300	ms	4
		Tf	Ta = 25°C	--	100	300		
Driving Method		Duty	1/16					
Viewing Direction		6 o'clock						

Note 1: definition of viewing angle  $\theta_1$  &  $\theta_2$

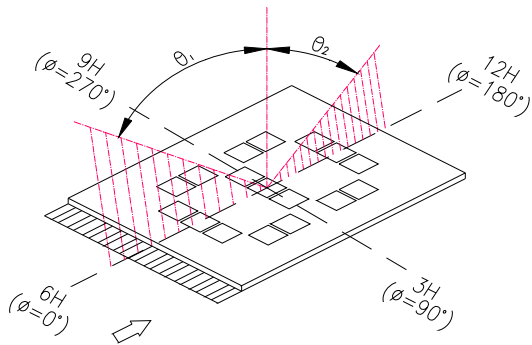

Note 2: definition of viewing angle  $\theta_3$  &  $\theta_4$

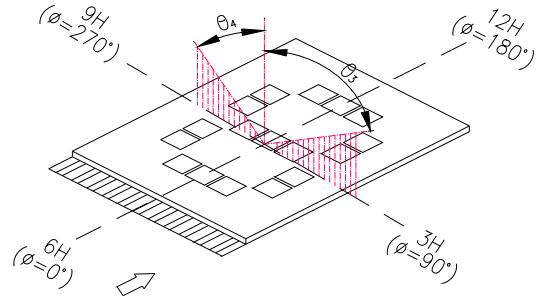

Note 3: definition of contrast ratio (CR)

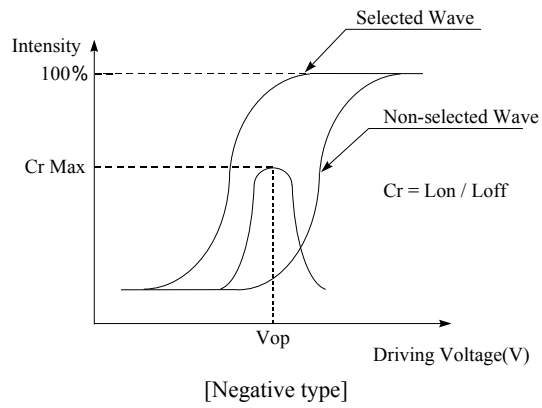
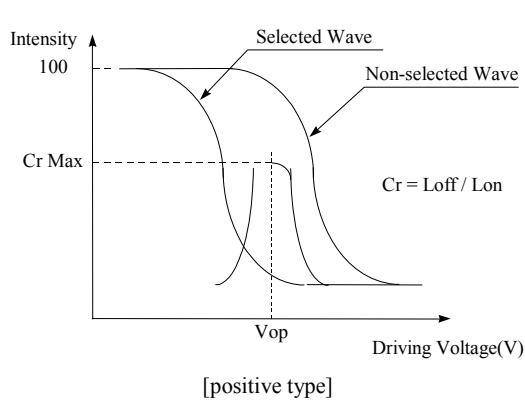

Note 4: definition of response time

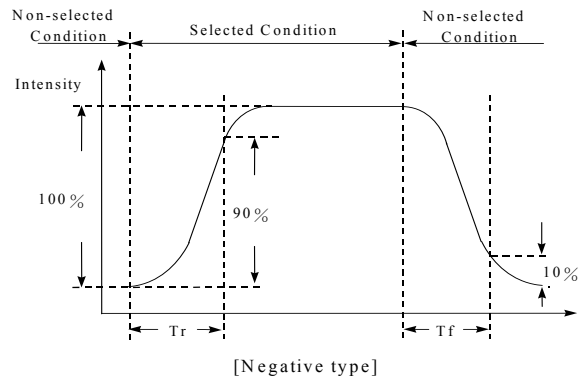
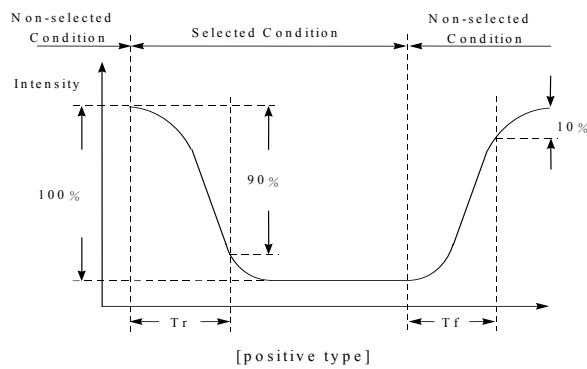

## 5 BACKLIGHT SPECIFICATION

### 5.1 BACKLIGHT CHARACTERISTICS

Item	Conditions	Standard			Unit
		Min.	Typ.	Max.	
Input voltage	Ta = 25 C	---	5.0	---	V(DC)
Current consumption	Ta = 25 C	---	56	---	mA
Average brightness (B/L only) (Ta = 25 C, IL = 56 mA)	Test when connecting after 3 min. Ta = 25 C (max. contrast)				cd/m2 (Note 3)
	Yellow-green array B/L	---	6	---	
Brightness uniformity	Ta = 25 C , IL = 56 mA	80	---	---	% (Note 4)
Lamp life	Ta = 25 C , IL = 56 mA Humidity : 30%RH ~ 85%RH	---	50,000	---	Hrs (Note 5)
Operating Temp.	Humidity : 30%RH ~ 85%RH	-20	---	70	C
Storage Temp.	Humidity : 30%RH ~ 85%RH	-30	---	80	C
limit resistor (R1)	Ta = 25 C	---	13	---	OHM (Note 1)

Note 1 : Built-in BL current limit resistor on LCM.

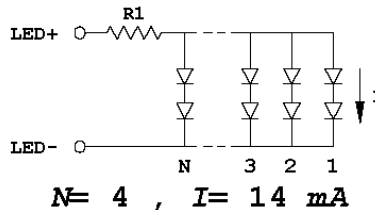

Note 3: Average brightness of 3 point when B/L is used at the beginning.

Note 4: Brightness uniformity = (MIN/MAX) x 100%

Note 5: Half of the original average brightness.

## 6 QUALITY ASSURANCE SPECIFICATION

### 6.1 CONFORMITY

---

The performance, function and reliability of the shipped products conform to the Product Specification.

### 6.2 DELIVERY ASSURANCE

---

#### 6.2.1 Delivery inspection standards

- IPC-AA610, class 2 electronic assemblies standard

#### 6.2.2 Zone definition

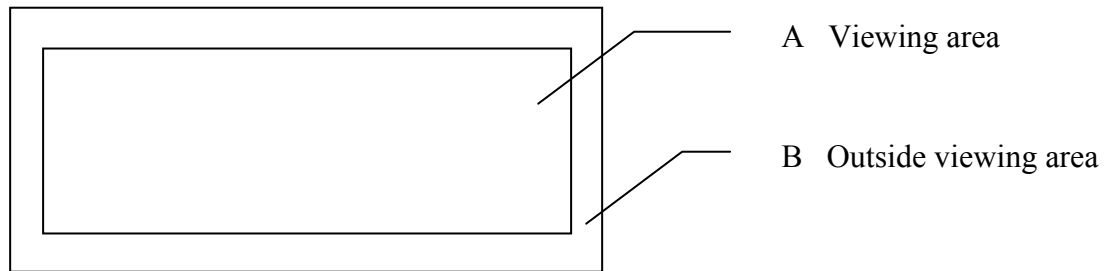

#### 6.2.3 Visual inspection

- Inspect under 2x20W or 40W fluorescent lamp (approximately 3000 lux) leaving 25 to 30 cm between the module and the lamp and 30 cm between the module and the eye (measuring position).
- Appearance is inspected at the best contrast voltage (best contrast is adjusted considering clearness and crosstalk on screen).
- Inspect the module at 45° right and left, top and bottom.
- Use the optimum viewing angle during the contrast inspection.

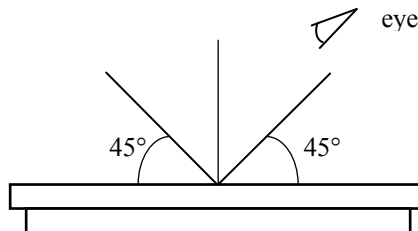

Product No.	LR4434	REV. A
-------------	--------	--------

Page	13 / 19
------	---------

### 6.2.3.1 Standard of appearance inspection

Units: mm

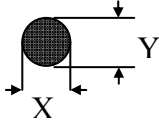
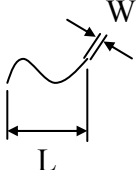
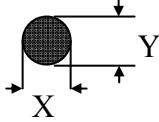
Class	Item	Criteria																																			
Minor	Packing & Label	Outside & inside package   Presence of product no., lot no., quantity																																			
Critical		Product must not be mixed with others and quantity must not be different from that indicated on the label																																			
Major	Dimension	Product dimensions must be according to specification and drawing																																			
Major	Electrical	Product electrical characteristics must be according to specification																																			
Critical	LCD Display	Missing lines or wrong patterns on LCD display are not allowed																																			
Minor	Black spot, white spot, dust	<p>Round type: as per following drawing  <math>\varnothing = (X+Y)/2</math></p>  <table border="1" style="margin-left: auto; margin-right: auto;"> <thead> <tr> <th colspan="3">Acceptable quantity</th> </tr> <tr> <th>Size</th> <th>Zone A</th> <th>Zone B</th> </tr> </thead> <tbody> <tr> <td><math>\varnothing &lt; 0.1</math></td> <td>Any number</td> <td rowspan="4">Any number</td> </tr> <tr> <td><math>0.1 &lt; \varnothing &lt; 0.2</math></td> <td>2</td> </tr> <tr> <td><math>0.2 &lt; \varnothing &lt; 0.25</math></td> <td>1</td> </tr> <tr> <td><math>0.25 &lt; \varnothing</math></td> <td>0</td> </tr> </tbody> </table> <p>Line type: as per following drawing</p>  <table border="1" style="margin-left: auto; margin-right: auto;"> <thead> <tr> <th colspan="4">Acceptable quantity</th> </tr> <tr> <th>Length</th> <th>Width</th> <th>Zone A</th> <th>Zone B</th> </tr> </thead> <tbody> <tr> <td>--</td> <td><math>W \leq 0.02</math></td> <td>Any number</td> <td rowspan="4">Any number</td> </tr> <tr> <td><math>L \leq 3.0</math></td> <td><math>0.02 &lt; W \leq 0.03</math></td> <td rowspan="2">2</td> </tr> <tr> <td><math>L \leq 2.5</math></td> <td><math>0.03 &lt; W \leq 0.05</math></td> </tr> <tr> <td>--</td> <td><math>0.05 &lt; W</math></td> <td>As round type</td> </tr> </tbody> </table> <p style="text-align: center;">Total acceptable quantity: 3</p>	Acceptable quantity			Size	Zone A	Zone B	$\varnothing < 0.1$	Any number	Any number	$0.1 < \varnothing < 0.2$	2	$0.2 < \varnothing < 0.25$	1	$0.25 < \varnothing$	0	Acceptable quantity				Length	Width	Zone A	Zone B	--	$W \leq 0.02$	Any number	Any number	$L \leq 3.0$	$0.02 < W \leq 0.03$	2	$L \leq 2.5$	$0.03 < W \leq 0.05$	--	$0.05 < W$	As round type
Acceptable quantity																																					
Size	Zone A	Zone B																																			
$\varnothing < 0.1$	Any number	Any number																																			
$0.1 < \varnothing < 0.2$	2																																				
$0.2 < \varnothing < 0.25$	1																																				
$0.25 < \varnothing$	0																																				
Acceptable quantity																																					
Length	Width	Zone A	Zone B																																		
--	$W \leq 0.02$	Any number	Any number																																		
$L \leq 3.0$	$0.02 < W \leq 0.03$	2																																			
$L \leq 2.5$	$0.03 < W \leq 0.05$																																				
--	$0.05 < W$	As round type																																			
Minor	Polariser scratch	Scratch on protective film is permitted Scratch on polariser: same as No. 1																																			
Minor	Polariser bubble	<p><math>\varnothing = (X+Y)/2</math></p>  <table border="1" style="margin-left: auto; margin-right: auto;"> <thead> <tr> <th colspan="3">Acceptable quantity</th> </tr> <tr> <th>Size</th> <th>Zone A</th> <th>Zone B</th> </tr> </thead> <tbody> <tr> <td><math>\varnothing &lt; 0.2</math></td> <td>Any number</td> <td rowspan="4">Any number</td> </tr> <tr> <td><math>0.2 &lt; \varnothing &lt; 0.5</math></td> <td>2</td> </tr> <tr> <td><math>0.5 &lt; \varnothing &lt; 1.0</math></td> <td>1</td> </tr> <tr> <td><math>1.0 &lt; \varnothing</math></td> <td>0</td> </tr> </tbody> </table> <p style="text-align: center;">Total acceptable quantity: 3</p>	Acceptable quantity			Size	Zone A	Zone B	$\varnothing < 0.2$	Any number	Any number	$0.2 < \varnothing < 0.5$	2	$0.5 < \varnothing < 1.0$	1	$1.0 < \varnothing$	0																				
Acceptable quantity																																					
Size	Zone A	Zone B																																			
$\varnothing < 0.2$	Any number	Any number																																			
$0.2 < \varnothing < 0.5$	2																																				
$0.5 < \varnothing < 1.0$	1																																				
$1.0 < \varnothing$	0																																				

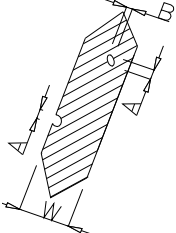
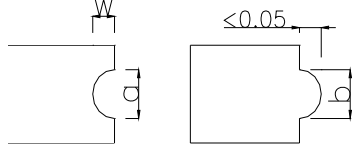
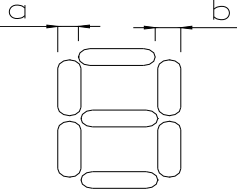
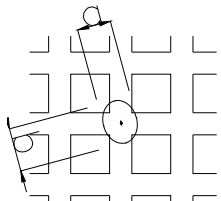
Class	Item	Criteria																												
Minor	Segment deformation	<p>1.a. Pin hole on segmented display</p> <p>W: segment width  <math>\varnothing = (A+B)/2</math></p>  <table border="1" style="margin-left: auto; margin-right: auto;"> <thead> <tr> <th colspan="2">Acceptable quantity</th> </tr> <tr> <th>Width</th> <th><math>\varnothing</math></th> </tr> </thead> <tbody> <tr> <td><math>W \leq 0.4</math></td> <td><math>\varnothing \leq 0.2</math> and <math>\varnothing \leq 1/2W</math></td> </tr> <tr> <td><math>W &gt; 0.4</math></td> <td><math>\varnothing \leq 0.25</math> and <math>\varnothing \leq 1/3W</math></td> </tr> </tbody> </table> <p>Total acceptable quantity: 1 defect per segment  Pin holes with <math>\varnothing</math> under 0.10 mm are acceptable</p>	Acceptable quantity		Width	$\varnothing$	$W \leq 0.4$	$\varnothing \leq 0.2$ and $\varnothing \leq 1/2W$	$W > 0.4$	$\varnothing \leq 0.25$ and $\varnothing \leq 1/3W$																				
Acceptable quantity																														
Width	$\varnothing$																													
$W \leq 0.4$	$\varnothing \leq 0.2$ and $\varnothing \leq 1/2W$																													
$W > 0.4$	$\varnothing \leq 0.25$ and $\varnothing \leq 1/3W$																													
Minor	Segment deformation	<p>1b. Pin hole on dot matrix display</p>  <table border="1" style="margin-left: auto; margin-right: auto;"> <thead> <tr> <th colspan="2">Acceptable quantity</th> </tr> <tr> <th>Size</th> <th></th> </tr> </thead> <tbody> <tr> <td><math>a, b &lt; 0.1</math></td> <td>Any number</td> </tr> <tr> <td><math>(a+b)/2 \leq 0.1</math></td> <td>Any number</td> </tr> <tr> <td><math>0.5 &lt; \varnothing &lt; 1.0</math></td> <td>3</td> </tr> </tbody> </table> <p>Total acceptable quantity: 7</p> <p>2. Segments / dots with different width</p>  <table border="1" style="margin-left: auto; margin-right: auto;"> <thead> <tr> <th colspan="2">Acceptable</th> </tr> <tr> <th><math>a \geq b</math></th> <th><math>a/b \leq 4/3</math></th> </tr> <tr> <th><math>a &lt; b</math></th> <th><math>a/b &gt; 4/3</math></th> </tr> </thead> </table> <p>3. Alignment layer defect</p> <p><math>\varnothing = (a+b)/2</math></p>  <table border="1" style="margin-left: auto; margin-right: auto;"> <thead> <tr> <th colspan="2">Acceptable quantity</th> </tr> <tr> <th>Size</th> <th></th> </tr> </thead> <tbody> <tr> <td><math>\varnothing \leq 0.4</math></td> <td>Any number</td> </tr> <tr> <td><math>0.4 &lt; \varnothing \leq 1.0</math></td> <td>5</td> </tr> <tr> <td><math>1.0 &lt; \varnothing \leq 1.5</math></td> <td>3</td> </tr> <tr> <td><math>1.5 &lt; \varnothing \leq 2.0</math></td> <td>2</td> </tr> </tbody> </table> <p>Total acceptable quantity: 7</p>	Acceptable quantity		Size		$a, b < 0.1$	Any number	$(a+b)/2 \leq 0.1$	Any number	$0.5 < \varnothing < 1.0$	3	Acceptable		$a \geq b$	$a/b \leq 4/3$	$a < b$	$a/b > 4/3$	Acceptable quantity		Size		$\varnothing \leq 0.4$	Any number	$0.4 < \varnothing \leq 1.0$	5	$1.0 < \varnothing \leq 1.5$	3	$1.5 < \varnothing \leq 2.0$	2
Acceptable quantity																														
Size																														
$a, b < 0.1$	Any number																													
$(a+b)/2 \leq 0.1$	Any number																													
$0.5 < \varnothing < 1.0$	3																													
Acceptable																														
$a \geq b$	$a/b \leq 4/3$																													
$a < b$	$a/b > 4/3$																													
Acceptable quantity																														
Size																														
$\varnothing \leq 0.4$	Any number																													
$0.4 < \varnothing \leq 1.0$	5																													
$1.0 < \varnothing \leq 1.5$	3																													
$1.5 < \varnothing \leq 2.0$	2																													
Minor	Colour uniformity	Level of sample for approval set as limit sample																												
Critical	Backlight	The backlight colour should correspond to the product specification																												
Critical		Flashing and or unlit backlight is not allowed																												
Minor		Dust larger than 0.25 mm is not allowed																												
Major	COB	Exposed wire bond pad is not allowed																												
Major		Insufficient covering with resin is not allowed (wire bond line exposed)																												
Minor		Dust or bubble on the resin are not allowed																												

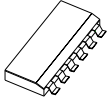
Class	Item	Criteria													
Major	 PCB	No unmelted solder paste should be present on PCB													
Critical		Cold solder joints, missing solder connections, or oxidation are not allowed													
Minor		No residue or solder balls on PCB are allowed													
Critical		Short circuits on components are not allowed													
Minor	Tray particles	<table border="1"> <thead> <tr> <th></th> <th>Size</th> <th>Quantity</th> </tr> </thead> <tbody> <tr> <td rowspan="2">On tray</td> <td><math>\varnothing &lt; 0.2</math></td> <td>Any number</td> </tr> <tr> <td><math>\varnothing &gt; 0.25</math></td> <td>4</td> </tr> <tr> <td rowspan="2">On display</td> <td><math>\varnothing \geq 0.25</math></td> <td>2</td> </tr> <tr> <td><math>L = 3</math></td> <td>1</td> </tr> </tbody> </table>		Size	Quantity	On tray	$\varnothing < 0.2$	Any number	$\varnothing > 0.25$	4	On display	$\varnothing \geq 0.25$	2	$L = 3$	1
	Size	Quantity													
On tray	$\varnothing < 0.2$	Any number													
	$\varnothing > 0.25$	4													
On display	$\varnothing \geq 0.25$	2													
	$L = 3$	1													



## 7 RELIABILITY SPECIFICATION

### 7.1 RELIABILITY TESTS

Test Item	Test Condition	Evaluation and assessment
Operation at High Temperature and Humidity	40°C±2°C 90% RH for 240 hours	No abnormalities in function* and appearance**
High Temperature Operation	70°C±2°C for 240 hours	No abnormalities in function* and appearance**
Low Temperature Operation	-20°C±2°C for 240 hours	No abnormalities in function* and appearance**
High Temperature Storage	80°C±2°C for 240 hours	No abnormalities in function* and appearance**
Low Temperature Storage	-30°C±2°C for 240 hours	No abnormalities in function* and appearance**
Heat Shock	-30°C (30 min)→ 25°C (5min)→ +80 (30min)→ 25°C (5 min) 10 cycles	No abnormalities in function* and appearance**
Vibration	Sweep for 1 minute at 10Hz, 55Hz, 10Hz, amplitude 1.5mm for 15 minutes in the X, Y and Z directions.	No abnormalities in function* and appearance**
Drop Shock	One angle, three edges and six sides. 75cm above ground (no weight difference).	No abnormalities in function* and appearance**

\* Current consumption < 2 times initial value

\*\* Contrast > ½ initial value

### 7.2 LIFE TIME

Item	Description
1	Function, performance, appearance, etc. shall be free from remarkable deterioration within 50,000 hours under ordinary operating and storage conditions of room temperature (25±10 °C), normal humidity (45±20% RH), and in area not exposed to direct sunlight.

## 8 PART NUMBER DESCRIPTIONS FOR AVAILABLE OPTIONS

### ALPHANUMERIC PART NUMBERING DESCRIPTION

**LR4434 ①②4C20③④⑤**

#### Model Number 4/5 Digits

##### ① POLARISER OPTIONS

B = Transflective: light background, with backlight.  
(EL or LED backlight).  
E = Transmissive: dark background, with backlight.

##### ② LED BACKLIGHT COLOR

G = Yellow-green

#### FORMAT: (4C20=4X20 module format)

##### ③ FLUID TYPE AND POWER SUPPLY

D = STN/NTN with +5VDC or ±5VDC operation.  
S = STN/NTN with +5VDC operation  
H = Extended temp with +5VDC operation

##### ④ FLUID TYPE AND TN VIEWING ANGLE

N = STN/NTN

##### ⑤ TN TEMPERATURE RANGE OR STN/NTN

###### BACKGROUND COLOUR

Y = Yellow mode STN/NTN (with B polarisers)  
G = Grey mode STN/NTN (with B polarisers)  
B = Blue mode STN/NTN (with E polarisers)

Product No.	LR4434	REV. A
-------------	--------	--------

Page	18 / 19
------	---------

## 9 HANDLING PRECAUTIONS

### *Safety*

If the LCD panel breaks, be careful not to get the liquid crystal fluid in your mouth or in your eyes.  
If the liquid crystal touches your skin or clothes, wash it off immediately using soap and plenty of water.

### *Mounting and Design*

Place a transparent plate (e.g. acrylic, polycarbonate or glass) on the display surface to protect the display from external pressure. Leave a small gap between the transparent plate and the display surface.  
When assembling with a zebra connector, clean the surface of the pads with alcohol and keep the surrounding air very clean. Design the system so that no input signal is given unless the power supply voltage is applied.

### *Caution during LCD cleaning*

Lightly wipe the display surface with a soft cloth soaked with Isopropyl alcohol, Ethyl alcohol or Trichlorotrifluoromethane. Do not wipe the display surface with dry or hard materials that will damage the polariser surface. Do not use aromatic solvents (toluene and xylene), or ketonic solvents (ketone and acetone).

### *Caution against static charge*

As the display uses C-MOS LSI drivers, connect any unused input terminal to VDD or VSS. Do not input any signals before power is turned on. Also, ground your body, work/assembly table and assembly equipment to protect against static electricity.

### *Packaging*

Displays use LCD elements, and must be treated as such. Avoid strong shock and drop from a height. To prevent displays from degradation, do not operate or store them exposed directly to sunshine or high temperature/humidity.

### *Caution during operation*

It is indispensable to drive the display within the specified voltage limit since excessive voltage shortens its life. Direct current causes an electrochemical reaction with remarkable deterioration of the display quality. Give careful consideration to prevent direct current during ON/OFF timing and during operation. Response time is extremely delayed at temperatures lower than the operating temperature range while, at high temperatures, displays become dark. However, this phenomenon is reversible and does not mean a malfunction or a display that has been permanently damaged. If the display area is pushed on hard during operation, some graphics will be abnormally displayed but returns to a normal condition after turning off the display once. Even a small amount of condensation on the contact pads (terminals) can cause an electro-chemical reaction which causes missing rows and columns. Give careful attention to avoid condensation.

### *Storage*

Store the display in a dark place where the temperature is 25°C ± 10°C and the humidity below 50%RH. Store the display in a clean environment, free from dust, organic solvents and corrosive gases. Do not crash, shake or jolt the display (including accessories).

Product No.	LR4434	REV. A
-------------	--------	--------

Page	19 / 19
------	---------