

LIQUID CRYSTAL DISPLAY MODULE

Product Specification

PRODUCT NUMBER	84-0221-000
PRODUCT DESCRIPTION	480x110 LCD MODULE, TRMNS, WHT B/L, MVA, RipDraw[®] Lite GPU, USB, SPI, RoHS IN PLASTIC CARRIER

Document Control	Engineering

TABLE OF CONTENTS

1	GENERAL SPECIFICATIONS	4
2	FEATURES.....	4
3	MECHANICAL DRAWING.....	5
4	ELECTRICAL CHARACTERISTICS.....	6
4.1	ABSOLUTE MAXIMUM RATINGS	6
4.2	RECOMMENDED OPERATING CONDITION.....	6
4.3	BACKLIGHT	6
5	INTERFACE PIN ASSIGNMENT.....	7
5.1	USB CONNECTOR.....	7
5.2	EXTERNAL 5V	7
5.3	SPI CONNECTOR.....	8
6	RIPDRAW® LITE COMMAND SET REV 1.0 PRELIMINARY	8
6.1	SYSTEM COMMANDS	8
6.2	FLASH COMMANDS.....	8
6.3	TEXT COMMANDS.....	9
6.4	IMAGE COMMANDS.....	10
6.5	LAYER RENDER COMMANDS	10
6.6	INITIALIZE STRUCTURE COMMANDS.....	10
7	OPTICAL CHARACTERISTICS	11
8	RELIABILITY TEST	14
9	QUALITY ASSURANCE.....	15
9.1	CONFORMITY.....	15
9.2	QUALITY SPECIFICATION	15
9.3	ZONE DEFINITION	15
9.4	INSPECTION CRITERIA.....	16
10	HANDLING PRECAUTIONS	20

REVISION RECORD

Rev.	Date	Page	Par.	Comment	ECN no.
A	12/18/14	--	--	New DCA Release	
B	2/23/15	5,7-10	--	Enhance Command Set, Update Mechanical Drawing, Add Connectors	

1 GENERAL SPECIFICATIONS

ITEM	DESCRIPTION	UNIT
Outline Dimension	133.74 (W) x 34.0 (H) x 14.0 (D) (Not including cable)	mm
Display Mode	Transmissive, Normally Black	-
LCD Surface Treatment	None	-
Viewing Area	95.24 (W) x 21.85 (H)	mm
Viewing Angle	Full View Angle (VA)	O' Clock
Pixel Pitch	0.198 x 0.198	mm
Pixel Arrangement	RGB Stripe	-
Technology Type	a-Si color TFT, MVA	-
Size	3.85	inch
Resolution	480 RGB x 110	pixels
Interface	USB 2.0 or SPI	-
Viewing Angle	70,70,70,70	
With/Without TSP	Without TSP	-
LED Numbers	10	-
RoHS Compliant	Yes	-

2 FEATURES

- The display module is a 1U rack mount supported TFT-LCD and can display 16 million collars.

3 MECHANICAL DRAWING

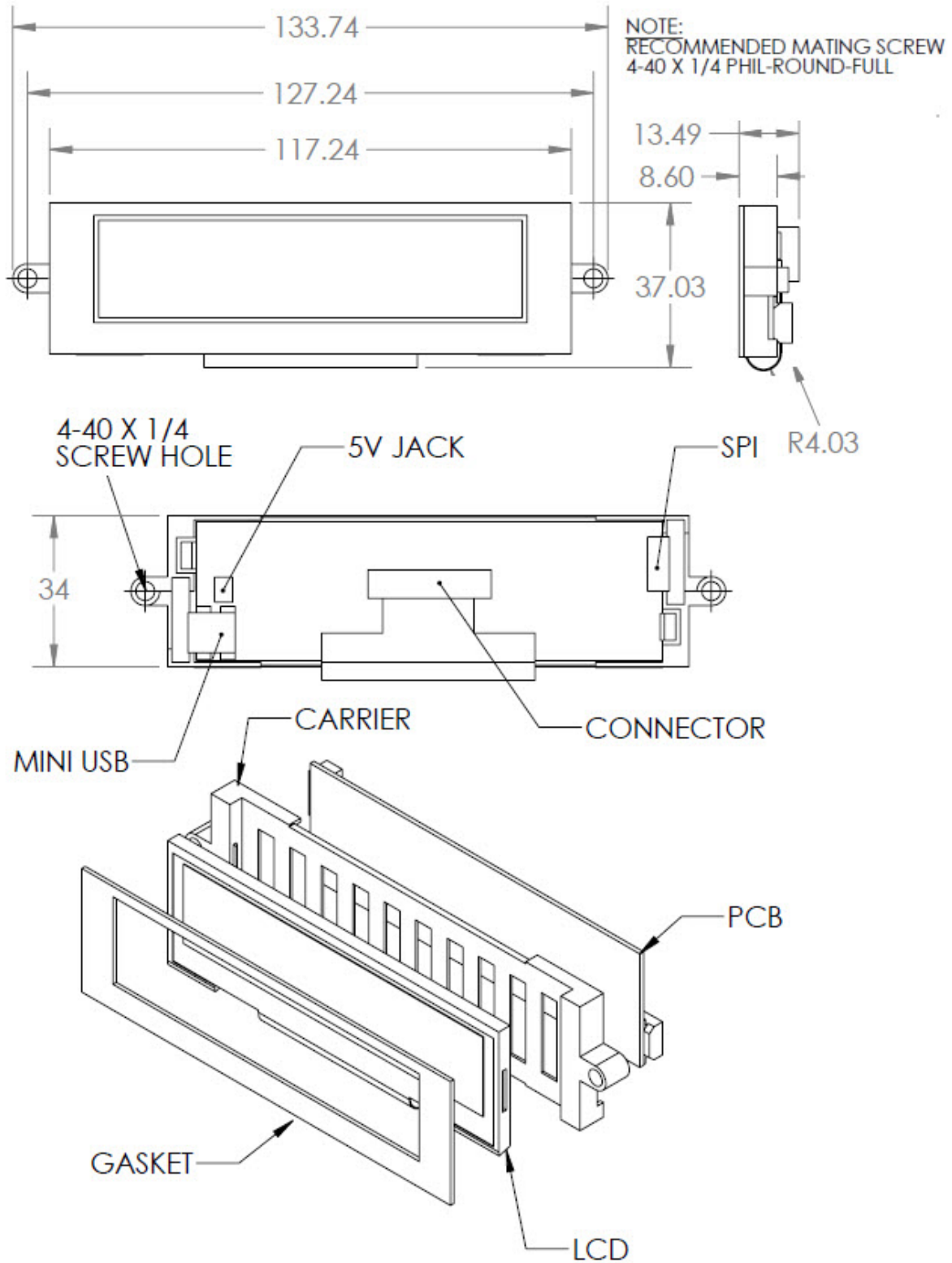

Solidworks Model available upon request: ripdraw@densitron.com

Product No.	84-0221-000	REV. B
-------------	-------------	--------

Page	5 / 20
------	--------

4 ELECTRICAL CHARACTERISTICS

4.1 Absolute Maximum Ratings

AGND = GND = 0V, Ta = 25°C

Item	Symbol	Min.	Max.	Unit	Remark
Power Voltage	V _{CC}	-4.85	5.15	V	-
Operating Temperature	T _{OPR}	-30	85	°C	-
Storage Temperature	T _{STG}	-40	90	°C	-

The absolute maximum rating values of this product are not allowed to be exceeded at any time. Should a module be used with any of the absolute maximum ratings exceeded, the characteristics of the module may not be recovered, or in an extreme case, the module may be permanently destroyed.

4.2 Recommended Operating Condition

AGND = GND = 0V, Ta = 25°C

Item	Symbol	Min.	Typ.	Max.	Unit
Power Voltage	V _{CC}	4.9	5.0	5.15	V
Input Logic High Voltage	V _{IH}	TBD V _{CC}	TBD V _{CC}	TBD V _{CC}	V
Input Logic Low Voltage	V _{IL}	TBD V _{CC}	TBD V _{CC}	TBD V _{CC}	V

4.3 Backlight

Ta = 25°C

Item	Symbol	Min.	Typ.	Max.	Unit	Note
Luminous Intensity	L _V	8,000	-	-	cd/m ²	
Chromaticity Coordinate	X	X=0.26	-	X=0.32	-	
	Y	Y=0.26	-	Y=0.32	-	
Operating Life Time	-	20,000			hours	2

Notes:

- The LED supply voltage is defined by the number of LED at Ta=25°C and I_F = 40mA.
- The “Operating Life Time” is defined as the module brightness decrease to 50% original brightness at Ta=25°C and I_F = 40mA. The LED lifetime could be decreased if operating I_F is larger than 40 mA.

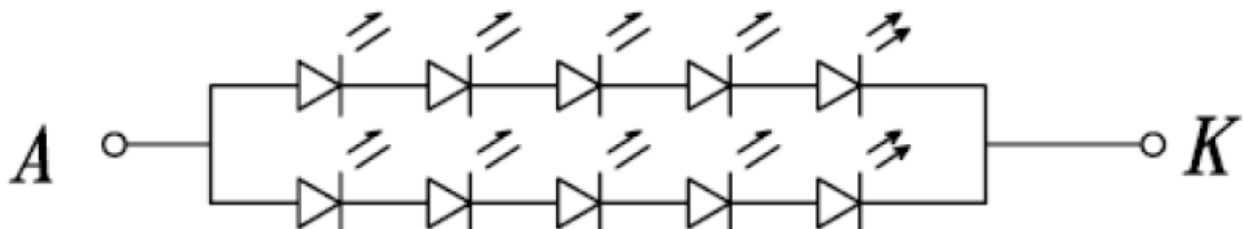

5 Interface Pin Assignment

External 5V * Development **

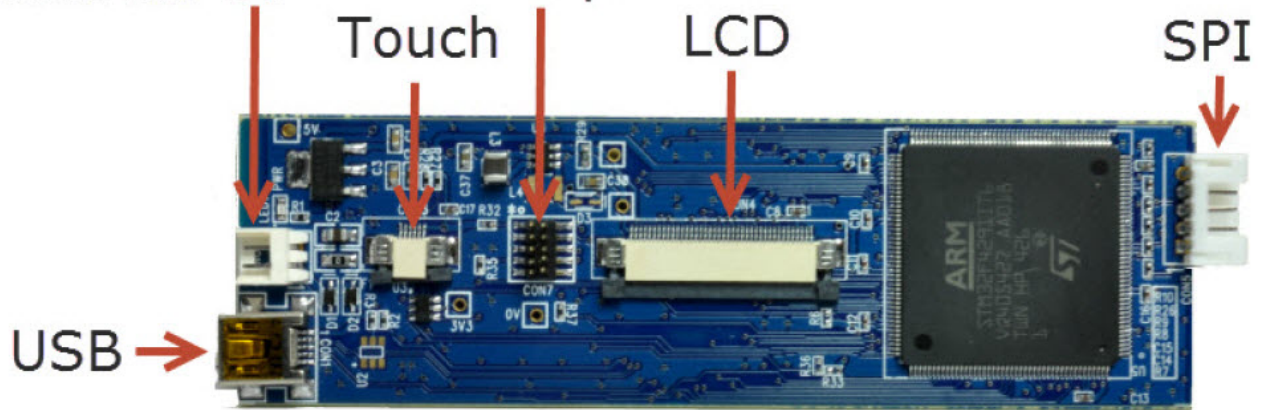

*5V Not required with USB driven from powered 2.0 host

** Optional install, Not required for normal operation

Reference	Value	PCB Footprint	Manufacturer	Manufacturer Part #
CON 1	Mini-B USB	MUSB-05-X-B-SM-A	Molex Inc	675031020
CON 2	5 Volt	SIP-2P	Molex Inc	532540270
CON 5	SPI	SIP-5P	Molex Inc	894010510

5.1 USB Connector

Pin No	Symbol	Description
1	VCC	+5 VDC
2	D-	Data -
3	D+	Data +
4	N/C	Unused
5	GND	Ground

5.2 External 5V

Pin No	Symbol	Description
1	VCC	+5 VDC (Unused when USB Powered from 2.0 Powered Host)
2	GND	Ground

5.3 SPI Connector

Pin No	Symbol	Description
1	CS	Slave Select (active low, output from master)
2	CK	SCK Serial Clock Serial Clock (output from master)
3	SO	MISO Master Input, Slave Output (output from slave)
4	SI	MOSI Master Output, Slave Input (output from master)
5	0V	Ground

6 RipDraw® Lite Command Set Rev 1.0 Preliminary

6.1 System Commands

// Get Max BackLight Brightness

```
RdStatus RdGetMaxBackLightBrightness(RdInterface* rdi, RdUWord* maxBacklightBrightness);
```

// Get BackLight Brightness

```
RdStatus RdGetBackLightBrightness(RdInterface* rdi, RdUWord* backlightBrightness);
```

// Set BackLight Brightness

```
RdStatus RdSetBackLightBrightness(RdInterface* rdi, RdUWord backlightBrightness);
```

// Information command

```
RdStatus RdSystemInfo(RdInterface* rdi, RdSystemInfoType type, char** output);
```

// Reset all

```
RdStatus RdReset(RdInterface* rdi);
```

// Free data

```
RdStatus RdFreeData(void* data);
```

6.2 FLASH Commands

// Set FlashWrite Enable

```
RdStatus RdFlashWriteEnable(RdInterface* rdi, RdFlag enable);
```

// Start file transfer

// Returns Transfer id

```
RdStatus RdFlashImage(RdInterface* rdi, RdUWord type, const char* filename, RdUInt32 length, RdId* transferId);
```

Product No.	84-0221-000	REV. B
-------------	-------------	--------

Page	8 / 20
------	--------

```
// File transfer chunk
RdStatus RdFlashData(RdInterface* rdi, RdId transferId, RdUWord type, const char* data,
RdUWord len);
```

```
// File delete
RdStatus RdFlashDelete(RdInterface* rdi, RdUWord type, const char* filename);
```

```
// File delete all
RdStatus RdFlashDeleteAll(RdInterface* rdi);
```

6.3 Text Commands

```
// Font Load
RdStatus RdFontLoad(RdInterface* rdi, const char* fontLabel, RdUWord* fontId);
```

```
// Font Release
RdStatus RdFontRelease(RdInterface* rdi, RdId fontId);
```

```
// Font padding
RdStatus RdSetFontPadding(RdInterface* rdi, RdId fontId, const RdByte padding);
```

```
// String write
RdStatus RdStringWrite(RdInterface* rdi, RdId layerId, RdPosition position, RdId fontId, RdColor
color, RdHDirection hDirection, const char* data, RdId* stringWriteId);
```

```
// String Replace
RdStatus RdStringReplace(RdInterface* rdi, RdId stringWriteId, const char* data);
```

```
// String delete
RdStatus RdStringDelete(RdInterface* rdi, RdId stringWriteId);
```

```
// Character write
RdStatus RdCharacterWrite(RdInterface* rdi, RdId layerId, RdPosition position, RdId contId,
RdColor color, RdByte c, RdId* characterWriteId);
```

```
// Character replace
RdStatus RdCharacterReplace(RdInterface* rdi, RdId characterWriteId, RdByte c);
```

```
// Character delete
RdStatus RdCharacterDelete(RdInterface* rdi, RdId characterWriteId);
```

```
// Create text window
RdStatus RdTextWindowCreate(RdInterface* rdi, RdId layerId, RdPosition position, RdSize size,
RdId fontId, RdColor fontColor, RdHDirection scrollDirection, RdUWord* textWindowId);
```

```
// Insert point for text window
```

Product No.	84-0221-000	REV. B
-------------	-------------	--------

Page	9 / 20
------	--------

```
RdStatus RdTextWindowSetInsertionPoint(RdInterface* rdi, RdId textWindowId, RdPosition position);
```

```
// Insert text in text window
```

```
RdStatus RdTextWindowInsertText(RdInterface* rdi, RdId textWindowId, const char* stringData);
```

```
// text window delete
```

```
RdStatus RdTextWindowDelete(RdInterface* rdi, RdId textWindowId);
```

6.4 Image Commands

```
// Load image of given name
```

```
// Returns image id of newly loaded image
```

```
RdStatus RdImageLoad(RdInterface* rdi, const char* imageLabel, RdId* imageId);
```

```
// Image Release
```

```
RdStatus RdImageRelease(RdInterface* rdi, RdId imageId);
```

```
// Image write
```

```
RdStatus RdImageWrite(RdInterface* rdi, RdId layerId, RdId imageId, RdPosition position, RdId* imageWriteId);
```

```
// Image Delete
```

```
RdStatus RdImageDelete(RdInterface* rdi, RdId imageWriteId);
```

```
// Image Move
```

```
RdStatus RdImageMove(RdInterface* rdi, RdId imageWriteId, RdPosition position);
```

6.5 Layer Render Commands

```
// Set Layer Enable
```

```
RdStatus RdSetLayerEnable(RdInterface* rdi, RdId layerId, RdFlag enable);
```

```
// Compose all Layers
```

```
RdStatus RdComposeLayersToPage(RdInterface* rdi, RdId pageId);
```

```
// shows page to screen
```

```
RdStatus RdPageToScreen(RdInterface* rdi, RdId pageId);
```

6.6 Initialize Structure Commands

```
RdPosition RdCreatePosition(RdUWord x, RdUWord y);
```

```
RdSize RdCreateSize(RdUWord width, RdUWord height);
```

```
RdColor RdCreateColor(RdByte red, RdByte green, RdByte blue, RdByte alpha);
```

```
int RdInitialize(RdInterface* rdi, int argc, char **argv);
```

```
int RdClose(RdInterface* rdi);
```

Product No.	84-0221-000	REV. B
-------------	-------------	--------

Page	10 / 20
------	---------

7 OPTICAL CHARACTERISTICS

Ta = 25°C

Item	Symbol	Condition	Min.	Typ.	Max.	Unit	Note
Viewing Angle	θT	CR \geq 10	-	70		deg	2
	θB		-	70	-	deg	
	θL		-	70	-	deg	
	θR		-	70	-	deg	
Contrast Ratio	CR	$\theta = 0^\circ$	-	500	-	-	1, 3
Response Time	T _{ON} + T _{OFF}	Ta = 25°C	-	35	-	ms	1, 4
Chromaticity	W _x	x	-	0.117	0.137	0.157	1, 5
	W _y	y	-	0.113	0.133	0.153	
Uniformity	U	-	80	-	-	%	5
Luminance	L	-	420	-	-	cd/m ²	1, 5

Test Conditions:

1. I_F = 40 mA (Backlight current), VCC = 3.3 V, the ambient temperature is 25°C.
2. The test systems refer to Note 2.

Note 1: Definition of optical measurement system.

The optical characteristics should be measured in dark room. After 5 Minutes operation, the optical properties are measured at the center point of the LCD screen. All input terminals LCD panel must be ground when measuring the center area of the panel.

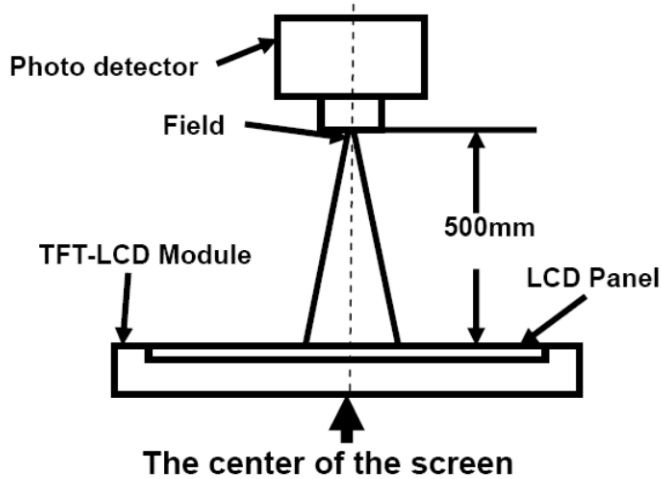

Item	Photo detector	Field
Contrast Ratio	BM-5A	1°
Luminance		
Lum Uniformity	SR-3A	
Chromaticity		
Response Time	TRD100	-

Note 2: Definition of viewing angle range and measurement system.

viewing angle is measured at the center point of the LCD by CONOSCOPE(ergo-80).

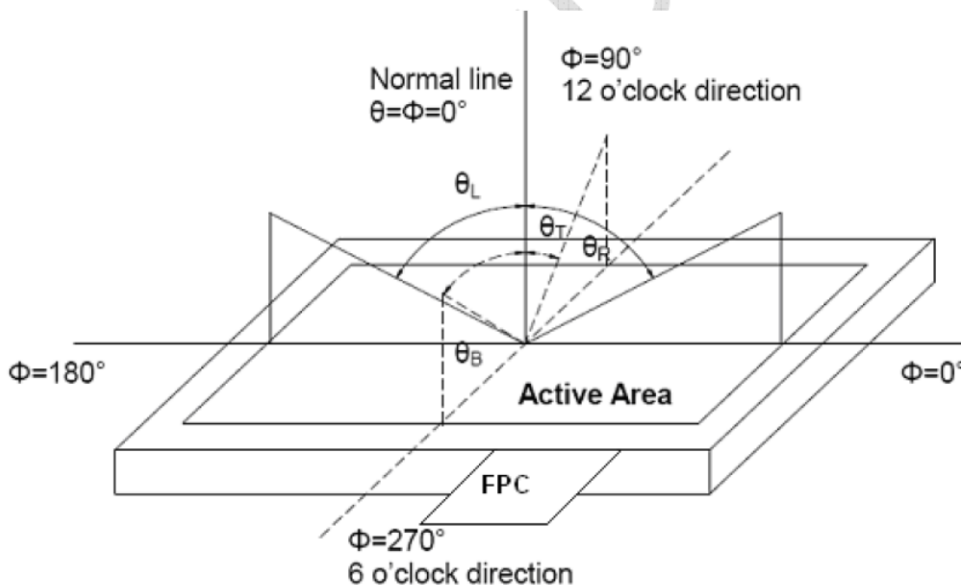

Note 3: Definition of contrast ratio

$$\text{Contrast ratio (CR)} = \frac{\text{Luminance measured when LCD is on the "White" state}}{\text{Luminance measured when LCD is on the "Black" state}}$$

"White state": The state is that the LCD should drive by V_{white} .

"Black state": The state is that the LCD should drive by V_{black} .

V_{white} : To be determined V_{black} : To be determined.

Note 4: Definition of Response time

The response time is defined as the LCD optical switching time interval between “White” state and “Black” state. Rise time (T_{ON}) is the time between photo detector output intensity changed from 90% to 10%. And fall time (T_{OFF}) is the time between photo detector output intensity changed from 10% to 90%.

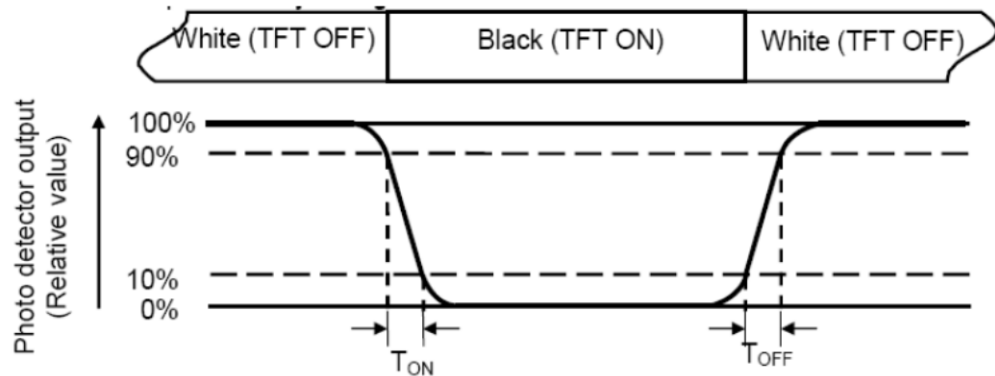

Note 5: Definition of color chromaticity (CIE1931)

Color coordinates measured at center point of LCD.

Note 6: Definition of Luminance Uniformity

Active area is divided into 9 measuring areas (Refer Fig. 2). Every measuring point is placed at the center of each measuring area.

$$\text{Luminance Uniformity (U)} = L_{\min} / L_{\max}$$

L-----Active area length W----- Active area width

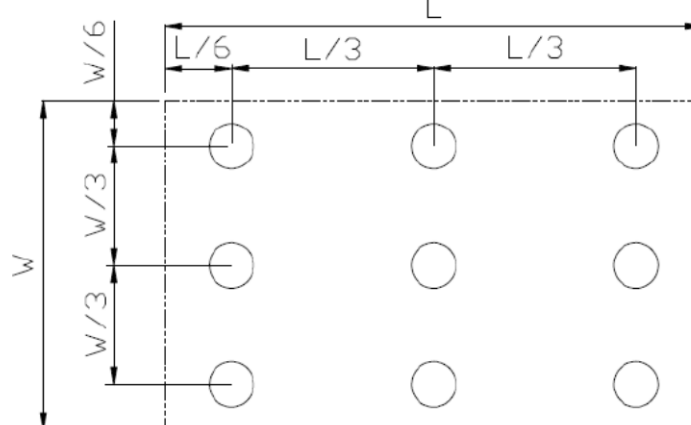

L_{\max} : The measured Maximum luminance of all measurement position.

L_{\min} : The measured Minimum luminance of all measurement position.

Note 7: Definition of Luminance:

Measure the luminance of white state at center point.

8 RELIABILITY TEST

No.	Test Item	Test Condition	Inspection after Test
1	High Temperature Storage	90 ± 2°C / 240 hours	Inspection after 2~4hours storage at room temperature, the sample shall be free from these defects: 1. Air bubble in the LCD 2. Seal leak 3. Non-display 4. Missing segments 5. Glass crack 6. Current IDD is twice as high as the initial value.
2	Low Temperature Storage	-30 ± 2°C / 240 hours	
3	High Temperature Operating	80 ± 2°C / 240 hours	
4	Low Temperature Operating	-30 ± 2°C / 240 hours	
5	Temperature Cycle	-30°C~25°C~ 80°C X 10cycles (60min) (5min) (60min)	
6	Damp Proof Test	60°C ± 5°C X 90%RH / 240hours	
7	Vibration Test	Frequency: 10Hz ~ 55Hz ~ 10Hz Amplitude: 1.5mm, X, Y, Z direction for total	
8	Drop Test	Drop from 1m height, once, each side of carton. (Packing condition)	
9	ESD Test	Voltage: ±6KV R: 330. C: 150pF Air discharge, 10times	

Remark:

1. The test samples should be applied to only one test item.
2. Sample size for each test item is 5~10pcs.
3. For Damp Proof Test, Pure water (Resistance > 10MΩ) should be used.
4. In case of malfunction defect caused by ESD damage, if it would be recovered to normal state after resetting, it would be judge as a good part.
5. EL evaluation should be accepted from reliability test with humidity and temperature: Some defects such as black spot/blemish can happen by natural chemical reaction with humidity and Fluorescence EL has.
6. Failure Judgment Criterion: Basic Specification, Electrical Characteristic, Mechanical Characteristic, Optical Characteristic.
7. Please use automatic switch menu (or roll menu) testing mode when test operating mode.

9 QUALITY ASSURANCE

9.1 Conformity

1. Test must be performed under 40W fluorescent light and the distance of view must be at 30 ± 10 cm.
2. Room temperature: $25 \pm 5^{\circ}\text{C}$
Humidity: $(60 \pm 10) \% \text{RH}$

9.2 Quality Specification

Quality specification shall be based on GB2828-87, inspection level II.

	Item	Check Level	AQL
MAJOR (MA)	<ol style="list-style-type: none"> 1. Liquid crystal leakage 2. Wrong polarizer 3. Outside dimension 4. Bright dot, Dark dot 5. Display abnormal 6. Class crack 	II	0.25
MINOR (MI)	<ol style="list-style-type: none"> 1. Spot Defect (Including black spot, white spot, pinhole, foreign particle, bubbles, damage) 2. Fragment 3. Line Defect (Including black line, white line, scratch) 4. Incision defect 5. Newton's ring 6. Other visual defects 	II	1.0

9.3 Zone Definition

- I Area: Viewing Area
II Area: Outside Viewing Area

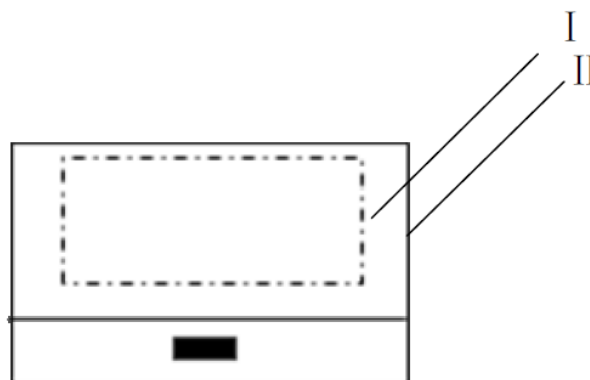

9.4 Inspection Criteria

8.4.1 Bright / Dark Dots Definition

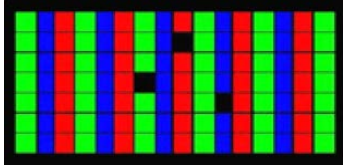
Name	Explanation	Definition
Bright Dot	Dots appear bright and unchanged in size in which LCD panel is displaying under black pattern 	The definition of dot: The size of a defective dot over 1/2 of single pixel dot is regarded as one defective dot. Note: One pixel consists of 3 sub-pixels, including R, G, and B dot. (Sub-pixel = Dot)
Dark Dot	Dots appear dark and unchanged in size in which LCD panel is displaying under pure red, green, blue pattern. 	
Adjacent Dot	Adjacent two sub-pixel are defect (define two dot defect)	

8.4.2 Inspection Standard

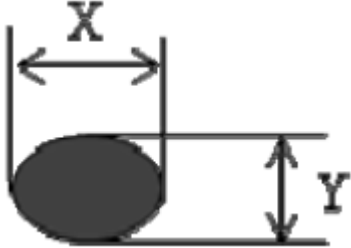
No.	Items	Criterion		Check Procedure	Defect Class
1	Bright / Dark Dot	Under 6" (Contain 6")	Bright dot: no Dark dot: N≤3 Note: be more than 5mm apart	Visual Examination	MAJ
		6" – 12"	Bright dot: N≤4 Dark dot: N≤5 Total Bright and Dark Dots: N≤8 Note: 1. Two bright dot defects (red, green, blue, and white) should be larger than 15mm ; 2. The distance between black dot defects or black and bright dot defects should be more than 5mm apart.		
2	Spot Defect (Including black spot, white spot, Pinhole, foreign particle, bubbles, damage)  $D=(X+Y)/2$	Under 6" (Contain 6")	D≤0.1 Ignore 0.1 < D ≤ 0.35 N≤3 0.35 < D N=0	Visual Examination	MIN
		6" – 12"	D≤0.3 Ignore 0.3 < D ≤ 0.6 N≤4 0.6 < D N=0		

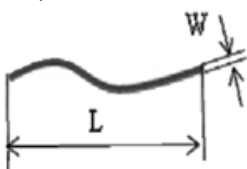
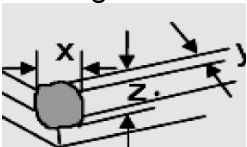
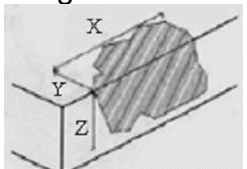
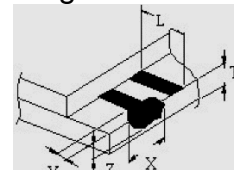
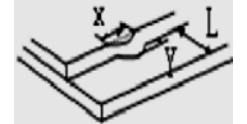
No.	Items	Criterion		Check Procedure	Defect Class
3	Line Defect (Including black line, white line, scratch) 	Under 6" (Contain 6")	W ≤ 0.02 Ignore 0.02 < W ≤ 0.04 L ≤ 5 N ≤ 2 0.04 < W ≤ 0.06 L ≤ 5 N ≤ 1 W > 0.06 N = 0	Visual Examination	MIN
		6" – 12"	W ≤ 0.07 Ignore 0.07 < W ≤ 0.1 L ≤ 10 N ≤ 4 W > 0.1 N = 0		
4	Display abnormal	Not allowed		Visual Examination	MAJ
5	Outside Dimension	According to drawing		Visual Examination	MAJ
6	Glass crack	Not allowed		Visual Examination	MAJ
7	Leak	Not allowed		Visual Examination	MAJ
8	Corner Fragment 	X ≤ 3 Y ≤ 3 Z ≤ T Ignore Note: 1. No hurt identifying wire, seal 2. T: Glass thickness X: Length Y: Width Z: thickness		Visual Examination	MIN
9	Side Fragment 	Y ≤ 1 Z ≤ T Ignore Note: 1. No hurt identifying wire, seal 2. T: Glass thickness X: Length Y: Width Z: thickness		Visual Examination	MIN
	Step Fragment 	Y ≤ 1 and Y ≤ 1/4 L		Visual Examination	MIN
	Incision Defect 	Y ≤ 1 and accord with outside dimension		Visual Examination	MIN

No.	Items	Criterion		Check Procedure	Defect Class
10	Newton's ring (CTP or Cover board)  $D=(X+Y)/2$	Under 6" (Contain 6")	$W \leq 0.02$ Ignore $0.02 < W \leq 0.04$ $L \leq 5$ $N \leq 2$ $0.04 < W \leq 0.06$ $L \leq 5$ $N \leq 1$ $W > 0.06$ $N = 0$	Visual Examination	MIN
		6" – 12"	$W \leq 0.07$ Ignore $0.07 < W \leq 0.1$ $L \leq 10$ $N \leq 4$ $W > 0.1$ $N =$		

10 HANDLING PRECAUTIONS

Safety

If the LCD panel breaks, be careful not to get the liquid crystal fluid in your mouth or in your eyes. If the liquid crystal touches your skin or clothes, wash it off immediately using soap and plenty of water.

Mounting and Design

Place a transparent plate (e.g. acrylic, polycarbonate or glass) on the display surface to protect the display from external pressure. Leave a small gap between the transparent plate and the display surface. When assembling with a zebra connector, clean the surface of the pads with alcohol and keep the surrounding air very clean. Design the system so that no input signal is given unless the power supply voltage is applied.

Caution during LCD cleaning

Lightly wipe the display surface with a soft cloth soaked with Isopropyl alcohol, Ethyl alcohol or Trichlorotrifluoroethane. Do not wipe the display surface with dry or hard materials that will damage the polarizer surface. Do not use aromatic solvents (toluene and xylene), or ketonic solvents (ketone and acetone).

Caution against static charge

As the display uses C-MOS LSI drivers, connect any unused input terminal to VDD or VSS. Do not input any signals before power is turned on. Also, ground your body, work/assembly table and assembly equipment to protect against static electricity.

Packaging

Displays use LCD elements, and must be treated as such. Avoid strong shock and drop from a height. To prevent displays from degradation, do not operate or store them exposed directly to sunshine or high temperature/humidity.

Caution during operation

It is indispensable to drive the display within the specified voltage limit since excessive voltage shortens its life. Direct current causes an electrochemical reaction with remarkable deterioration of the display quality. Give careful consideration to prevent direct current during ON/OFF timing and during operation. Response time is extremely delayed at temperatures lower than the operating temperature range while, at high temperatures, displays become dark. However, this phenomenon is reversible and does not mean a malfunction or a display that has been permanently damaged. If the display area is pushed on hard during operation, some graphics will be abnormally displayed but returns to a normal condition after turning off the display once. Even a small amount of condensation on the contact pads (terminals) can cause an electro-chemical reaction which causes missing rows and columns. Give careful attention to avoid condensation.

Storage

Store the display in a dark place where the temperature is $25^{\circ}\text{C} \pm 10^{\circ}\text{C}$ and the humidity below 50%RH. Store the display in a clean environment, free from dust, organic solvents and corrosive gases. Do not crash, shake or jolt the display (including accessories).

Product No.	84-0221-000	REV. B
-------------	-------------	--------

Page	20 / 20
------	---------