

LIQUID CRYSTAL DISPLAY MODULE

Standard Product Specification

PRODUCT NUMBER	LMR2048
---------------------------	----------------

Product Mgr	Quality Mgr	Engineering	Document Control
Date:	Date:	Date:	Date:

- Approval for Specification only**
- Approval for Specification and Sample**

Sample no.:

Date:

ISIR no.:

Product No.	LMR2048	REV. A
-------------	---------	--------

Page	1 / 23
------	--------

TABLE OF CONTENTS

1	MAIN FEATURES	4
2	MECHANICAL SPECIFICATION.....	5
2.1	MECHANICAL CHARACTERISTICS	5
2.2	LABELLING & MARKING.....	5
2.3	MECHANICAL DRAWING	6
3	ELECTRICAL SPECIFICATION.....	7
3.1	ABSOLUTE MAXIMUM RATINGS	7
3.2	ELECTRICAL CHARACTERISTICS	7
3.3	RECOMMENDED LC DRIVE VOLTAGE (VDD-VO).....	8
3.4	INTERFACE PIN ASSIGNMENT	8
3.5	BLOCK DIAGRAM	9
3.6	POWER SUPPLY CIRCUIT	9
3.7	TIMING CHARACTERISTICS	10
3.8	CHARACTER FONT	12
4	OPTICAL SPECIFICATION.....	13
4.1	OPTICAL CHARACTERISTICS.....	13
5	QUALITY ASSURANCE SPECIFICATION.....	15
5.1	CONFORMITY	15
5.2	DELIVERY ASSURANCE	15
5.3	DEALING WITH CUSTOMER COMPLAINTS	20
6	RELIABILITY SPECIFICATION	21
6.1	RELIABILITY TESTS	21
6.2	LIFE TIME.....	21
7	PART NUMBER DESCRIPTIONS FOR AVAILABLE OPTIONS.....	22
8	HANDLING PRECAUTIONS.....	23

REVISION RECORD

Rev.	Date	Page	Chapt.	Comment	ECN no.
A	11/08/10	--	--	Standard Specification Release, ROHS compliant	E4370

1 MAIN FEATURES

UNIT=MM

ITEM	CONTENTS
Display Format	2 Line x 16 Characters
Colour	Monochrome
Overall Dimensions	65.0 (W) x 19.5 (H) x 5.3 (D)
Viewing Area	60.0 (W) x 11.5 (H)
LCD Type	STN
Mode	Transflective - Positive
Viewing Angle	6:00
Duty Ratio	1/16 duty , ¼ Bias drive
Controller IC	Sitronix ST7066
Operating Temperature	-20°C~+70°C
Storage Temperature	-30°C~+80°C
ROHS Compliant	Yes

2 MECHANICAL SPECIFICATION

2.1 MECHANICAL CHARACTERISTICS

ITEM	CHARACTERISTIC	UNIT
Display Format	2 Line x 16 Characters	
Character Format	5 (W) x 7 (H) with attached cursor	--
Overall Dimensions	65.0 (W) x 19.5 (H) x 5.3 (D)	mm
Viewing Area	60.0 (W) x 11.5 (H)	mm
Active Area	54.7 (W) x 9.0 (H)	mm
Character Size	2.95 (W) x 4.35 (H)	mm
Character Pitch	3.45 (W) x 4.69 (H)	mm
Dot Size	0.55 (W) x 0.50 (H)	mm
Dot Pitch	0.60 (W) x 0.55 (H)	mm
IC Controller/Driver	Sitronix ST7066	

2.2 LABELLING & MARKING

DENSITRON LMR2048 TAIWAN YYMM

2.3 MECHANICAL DRAWING

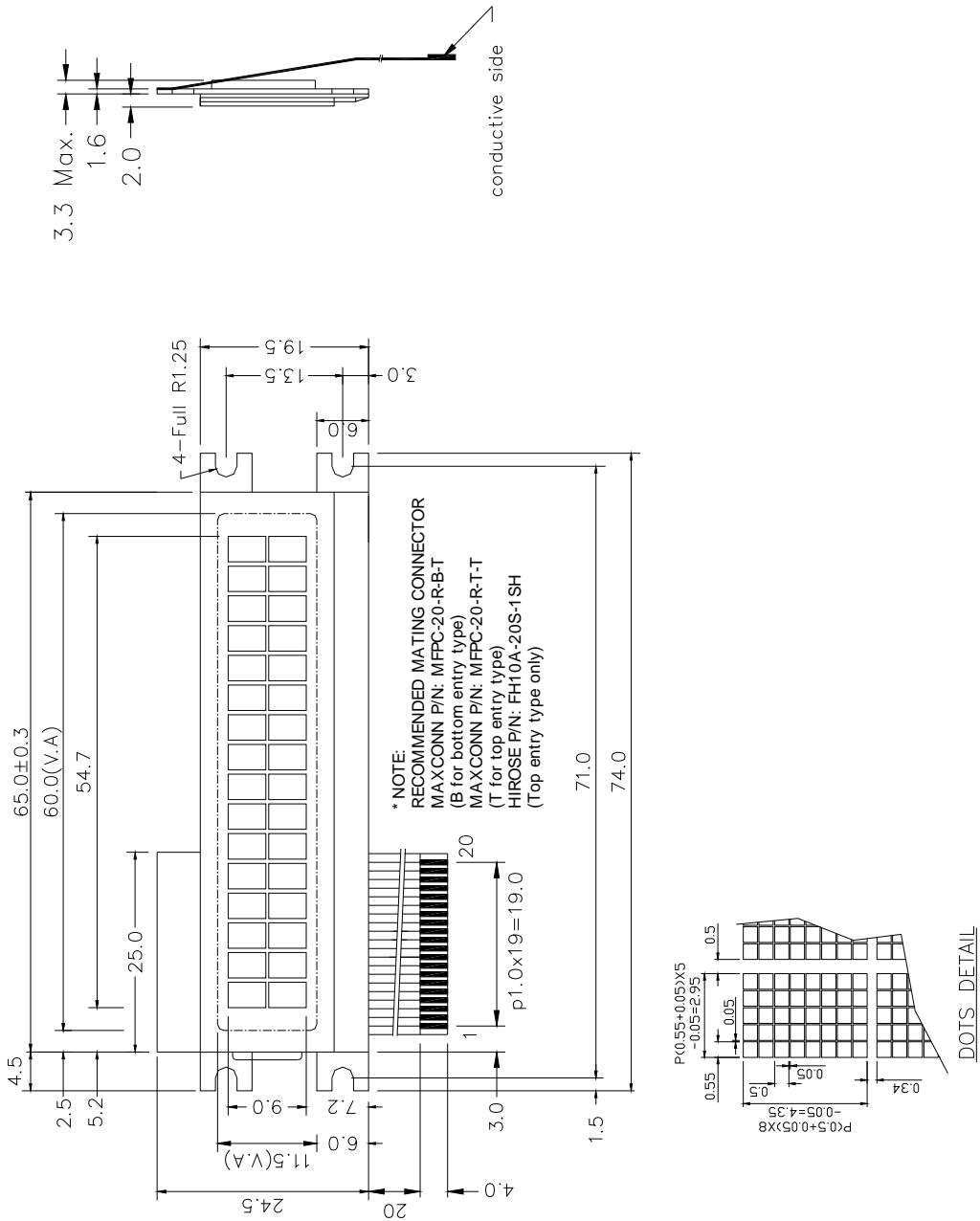

Product No.	LMR2048	REV. A
-------------	---------	--------

Page	6 / 23
------	--------

3 ELECTRICAL SPECIFICATION

3.1 ABSOLUTE MAXIMUM RATINGS

VSS = 0 V, Ta = 25 °C

Item	Symbol	Min	Max	Unit	Note
Power Supply Voltage	V _{DD} -V _{SS}	0	7.0	V	
LC Driver Supply Voltage	V _{DD} -V _O	0	13.0	V	
Operating Temperature	Top	-20	+70	°C	Note 1
Storage Temperature	Tst	-30	+80	°C	Note 2
Static Electricity	Be sure that you are grounded when handling displays.				

Note 1: Background colour changes slightly depending on ambient temperature. This phenomenon is reversible. Ta ≤ 70 °C: 75% RH max

Note 2: Ta ≤ 80 °C: 75% RH max

3.2 ELECTRICAL CHARACTERISTICS

VSS = 0 V, Ta = 25 °C

Item	Symbol	Condition	Min	Typ	Max	Unit
Power Supply for Logic	V _{DD} -V _{SS}	Ta = 25°C	4.75	--	5.25	V
Input Voltage	V _{IH}	Ta = 25°C	0.7V _{dd}	--	V _{DD}	V
	V _{IL}	Ta = 25°C	0	--	0.6	V
LCD driving voltage	V _{dd} -V _o	--	3.0	--	10.0	V
Supply current	I _{dd}	V _{dd} -V _{ss} =5V	--	1	--	mA

3.3 RECOMMENDED LC DRIVE VOLTAGE (VDD-VO)

VDD=5.0±0.25V

Temperature	STN-H
T _a = -20°C	4.5
T _a = 0°C	4.5
T _a = 25°C	4.5
T _a = 50°C	4.5
T _a =70°C	4.5

3.4 INTERFACE PIN ASSIGNMENT

Pin No.	Symbol	I/O	Function
1	N/C	-	No Connection
2	N/C	-	No Connection
3	V _{SS}	-	Ground (0V)
4	V _{DD}	-	Logic Supply Voltage (+5V) / (+3V)
5	V _O	-	LC Drive voltage for contrast adjustment
6	RS	I	Register Select 0: Instruction Register 1: Data Register
7	R/W	I	Read / Write 0: Data Write (Module←MPU) 1: Data Read (Module→MPU)
8	E	I	Enable Signal Active High (H → L)
9	DB0	I/O	Bi-directional data bus line 0
10	DB1	I/O	Bi-directional data bus line 1
11	DB2	I/O	Bi-directional data bus line 2
12	DB3	I/O	Bi-directional data bus line 3
13	DB4	I/O	Bi-directional data bus line 4
14	DB5	I/O	Bi-directional data bus line 5
15	DB6	I/O	Bi-directional data bus line 6
16	DB7	I/O	Bi-directional data bus line 7
17	N/C	-	No Connection
18	N/C	-	No Connection
19	V _{EE}	-	Negative voltage output for models with on-board negative voltage generators
20	N/C	-	No Connection

3.5 BLOCK DIAGRAM

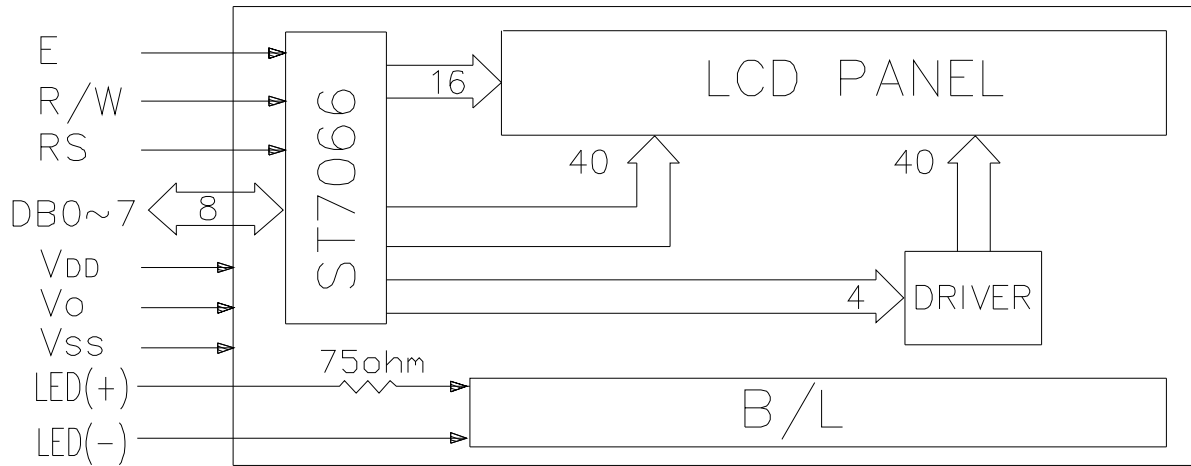

3.6 POWER SUPPLY CIRCUIT

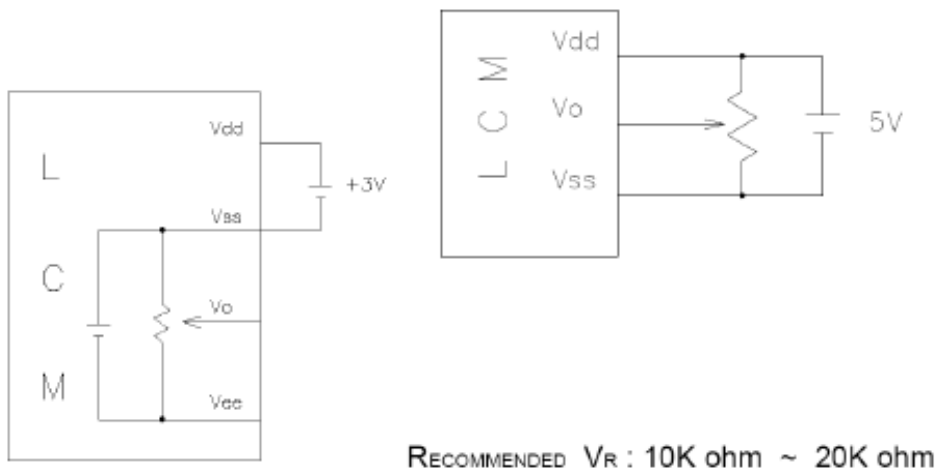

3.7 TIMING CHARACTERISTICS

AC Characteristics

Symbol	Characteristics	Test Condition	Min.	Typ.	Max.	Unit
<i>Write Mode (Writing data from MPU to ST7066U)</i>						
T _C	Enable Cycle Time	Pin E	1200	-	-	ns
T _{FW}	Enable Pulse Width	Pin E	140	-	-	ns
T _{R,T_F}	Enable Rise/Fall Time	Pin E	-	-	25	ns
T _{AS}	Address Setup Time	Pins: RS,RW,E	0	-	-	ns
T _{AH}	Address Hold Time	Pins: RS,RW,E	10	-	-	ns
T _{DSW}	Data Setup Time	Pins: DB0 - DB7	40	-	-	ns
T _H	Data Hold Time	Pins: DB0 - DB7	10	-	-	ns
<i>Read Mode (Reading Data from ST7066U to MPU)</i>						
T _C	Enable Cycle Time	Pin E	1200	-	-	ns
T _{FW}	Enable Pulse Width	Pin E	140	-	-	ns
T _{R,T_F}	Enable Rise/Fall Time	Pin E	-	-	25	ns
T _{AS}	Address Setup Time	Pins: RS,RW,E	0	-	-	ns
T _{AH}	Address Hold Time	Pins: RS,RW,E	10	-	-	ns
T _{DOR}	Data Setup Time	Pins: DB0 - DB7	-	-	100	ns
T _H	Data Hold Time	Pins: DB0 - DB7	10	-	-	ns

3.8 CHARACTER FONT

h7-h4 h3-h0	0000	0001	0010	0011	0100	0101	0110	0111	1000	1001	1010	1011	1100	1101	1110	1111
0000				0	1	P	'	F				-	タ	ミ	%	p
0001			!	1	A	Q	a	q			。	ア	チ	△	△	q
0010			"	2	B	R	b	r			「	イ	ツ	×	⊖	⊖
0011			#	3	C	S	c	s			」	ウ	テ	⊕	⊕	⊕
0100			\$	4	D	T	d	t			、	エ	ト	⊕	⊕	⊕
0101			%	5	E	U	e	u			・	オ	ナ	⊕	⊕	⊕
0110			&	6	F	V	f	v			ヲ	カ	ニ	ヨ	⊕	⊕
0111			'	7	G	W	g	w			ヲ	キ	ヌ	ラ	⊕	⊕
1000			<	8	H	X	h	x			イ	ク	ネ	リ	⊕	⊕
1001			>	9	I	Y	i	y			ウ	ケ	ノ	ル	'	⊕
1010			* :	J	Z	j	z				エ	コ	ノ	レ	⊕	⊕
1011			+ ;	K	L	k	l				オ	サ	ヒ	ロ	'	⊕
1100			、 <	L	¥	l	l				カ	シ	フ	ワ	⊕	⊕
1101			- =	M	J	m	›				ユ	ス	ノ	シ	⊕	⊕
1110			。 >	N	^	n	→				ヨ	セ	ホ	ノ	⊕	⊕
1111			/ ?	O	o	←					ッ	ソ	マ	”	〇	■

4 OPTICAL SPECIFICATION

4.1 OPTICAL CHARACTERISTICS

Ta = 25 °C

Item	Symbol	Condition	Min	Typ	Max	Unit	Note	
Viewing Angle	θ1	CR≥2	--	45	--	deg	1	
	θ2	CR≥2	--	30	--	deg	1	
	θ3	CR≥2	--	30	--	deg	2	
	θ4	CR≥2	--	30	--	deg	2	
Contrast Ratio	STN(-H)	CR	Ta = 25°C	2	4	--	-	3
Response Time	Tr	Ta = 25°C	--	150	250	ms	4	
	Tf	Ta = 25°C	--	150	250			
Driving Method	Duty	1/16						
LCD Type	STN – Transflective - Positive							
Viewing Direction	6:00							

Note 1: definition of viewing angle θ_1 & θ_2

Note 2: definition of viewing angle θ_3 & θ_4

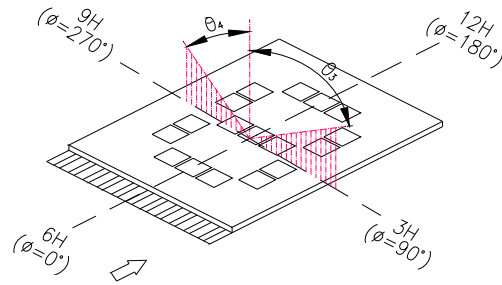
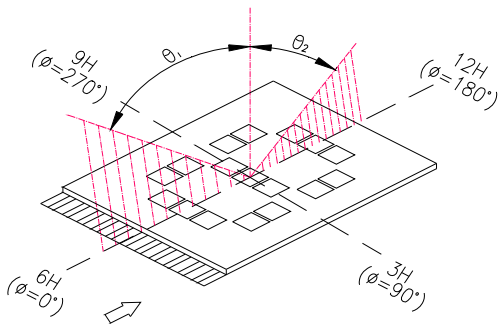

Note 3: definition of contrast ratio (CR)

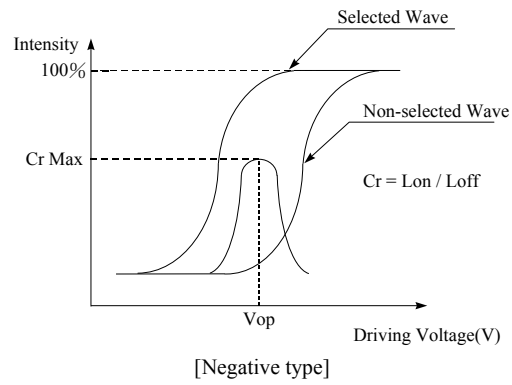
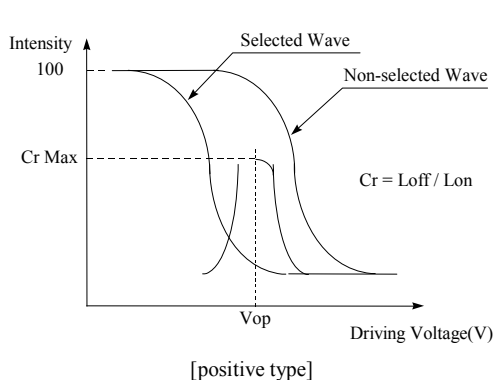

Note 4: definition of response time

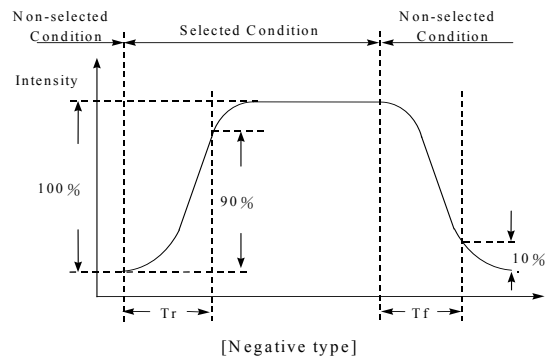
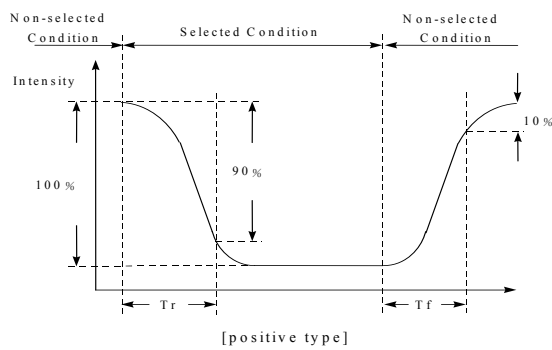

5 QUALITY ASSURANCE SPECIFICATION

5.1 CONFORMITY

The performance, function and reliability of the shipped products conform to the Product Specification.

5.2 DELIVERY ASSURANCE

5.2.1 Delivery inspection standards

- MIL-STD-105E, general inspection level II, single sampling level;
- IPC-AA610 rev. C, class 2 electronic assemblies standard

The quality assurance levels are shown below:

Class	AQL (%)
Critical defect	0.5%
Major defect	1.0%
Minor defect	1.5%
TOTAL	2.0%

5.2.2 Zone definition

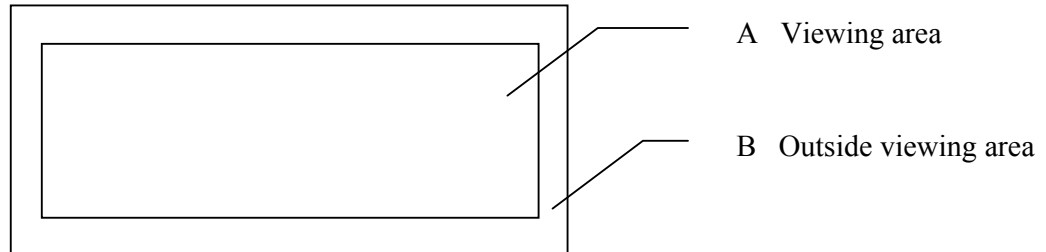

5.2.3 Visual inspection

- Inspect under 2x20W or 40W fluorescent lamp (approximately 3000 lux) leaving 25 to 30 cm between the module and the lamp and 30 cm between the module and the eye (measuring position).
- Appearance is inspected at the best contrast voltage (best contrast is adjusted considering clearness and crosstalk on screen).
- Inspect the module at 45° right and left, top and bottom.
- Use the optimum viewing angle during the contrast inspection.

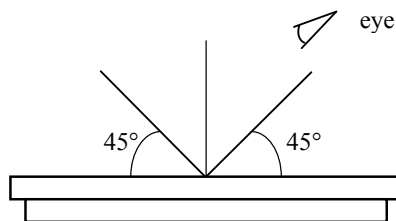

5.2.3.1 Standard of appearance inspection

Units: mm

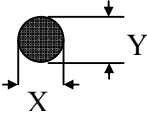
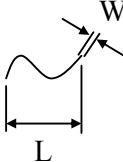
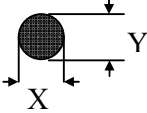
Class	Item	Criteria																																				
Minor	Packing & Label	Outside & inside package Presence of product no., lot no., quantity																																				
Critical		Product must not be mixed with others and quantity must not be different from that indicated on the label																																				
Major	Dimension	Product dimensions must be according to specification and drawing																																				
Major	Electrical	Product electrical characteristics must be according to specification																																				
Critical	LCD Display	Missing lines or wrong patterns on LCD display are not allowed																																				
Minor	Black spot, white spot, dust	<p>Round type: as per following drawing $\varnothing = (X+Y)/2$</p>  <table border="1" style="margin-left: 200px;"> <thead> <tr> <th colspan="3">Acceptable quantity</th> </tr> <tr> <th>Size</th> <th>Zone A</th> <th>Zone B</th> </tr> </thead> <tbody> <tr> <td>$\varnothing < 0.1$</td> <td>Any number</td> <td rowspan="4">Any number</td> </tr> <tr> <td>$0.1 < \varnothing < 0.2$</td> <td>2</td> </tr> <tr> <td>$0.2 < \varnothing < 0.25$</td> <td>1</td> </tr> <tr> <td>$0.25 < \varnothing$</td> <td>0</td> </tr> </tbody> </table> <p>Line type: as per following drawing</p>  <table border="1" style="margin-left: 200px;"> <thead> <tr> <th colspan="4">Acceptable quantity</th> </tr> <tr> <th>Length</th> <th>Width</th> <th>Zone A</th> <th>Zone B</th> </tr> </thead> <tbody> <tr> <td>--</td> <td>$W \leq 0.02$</td> <td>Any number</td> <td rowspan="3">Any number</td> </tr> <tr> <td>$L \leq 3.0$</td> <td>$0.02 < W \leq 0.03$</td> <td rowspan="2">2</td> </tr> <tr> <td>$L \leq 2.5$</td> <td>$0.03 < W \leq 0.05$</td> </tr> <tr> <td>--</td> <td>$0.05 < W$</td> <td>As round type</td> <td></td> </tr> </tbody> </table> <p style="text-align: center;">Total acceptable quantity: 3</p>	Acceptable quantity			Size	Zone A	Zone B	$\varnothing < 0.1$	Any number	Any number	$0.1 < \varnothing < 0.2$	2	$0.2 < \varnothing < 0.25$	1	$0.25 < \varnothing$	0	Acceptable quantity				Length	Width	Zone A	Zone B	--	$W \leq 0.02$	Any number	Any number	$L \leq 3.0$	$0.02 < W \leq 0.03$	2	$L \leq 2.5$	$0.03 < W \leq 0.05$	--	$0.05 < W$	As round type	
Acceptable quantity																																						
Size	Zone A	Zone B																																				
$\varnothing < 0.1$	Any number	Any number																																				
$0.1 < \varnothing < 0.2$	2																																					
$0.2 < \varnothing < 0.25$	1																																					
$0.25 < \varnothing$	0																																					
Acceptable quantity																																						
Length	Width	Zone A	Zone B																																			
--	$W \leq 0.02$	Any number	Any number																																			
$L \leq 3.0$	$0.02 < W \leq 0.03$	2																																				
$L \leq 2.5$	$0.03 < W \leq 0.05$																																					
--	$0.05 < W$	As round type																																				
Minor	Polariser scratch	Scratch on protective film is permitted Scratch on polariser: same as No. 1																																				
Minor	Polariser bubble	<p>$\varnothing = (X+Y)/2$</p>  <table border="1" style="margin-left: 200px;"> <thead> <tr> <th colspan="3">Acceptable quantity</th> </tr> <tr> <th>Size</th> <th>Zone A</th> <th>Zone B</th> </tr> </thead> <tbody> <tr> <td>$\varnothing < 0.2$</td> <td>Any number</td> <td rowspan="4">Any number</td> </tr> <tr> <td>$0.2 < \varnothing < 0.5$</td> <td>2</td> </tr> <tr> <td>$0.5 < \varnothing < 1.0$</td> <td>1</td> </tr> <tr> <td>$1.0 < \varnothing$</td> <td>0</td> </tr> </tbody> </table> <p style="text-align: center;">Total acceptable quantity: 3</p>	Acceptable quantity			Size	Zone A	Zone B	$\varnothing < 0.2$	Any number	Any number	$0.2 < \varnothing < 0.5$	2	$0.5 < \varnothing < 1.0$	1	$1.0 < \varnothing$	0																					
Acceptable quantity																																						
Size	Zone A	Zone B																																				
$\varnothing < 0.2$	Any number	Any number																																				
$0.2 < \varnothing < 0.5$	2																																					
$0.5 < \varnothing < 1.0$	1																																					
$1.0 < \varnothing$	0																																					

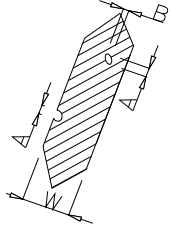
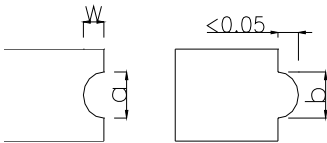
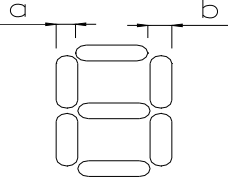
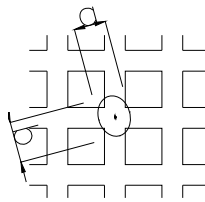
Class	Item	Criteria																												
Minor	Segment deformation	<p>1.a. Pin hole on segmented display</p> <p>W: segment width $\varnothing = (A+B)/2$</p>  <table border="1" style="margin-left: auto; margin-right: auto;"> <thead> <tr> <th colspan="2">Acceptable quantity</th> </tr> <tr> <th>Width</th> <th>\varnothing</th> </tr> </thead> <tbody> <tr> <td>$W \leq 0.4$</td> <td>$\varnothing \leq 0.2$ and $\varnothing \leq 1/2W$</td> </tr> <tr> <td>$W > 0.4$</td> <td>$\varnothing \leq 0.25$ and $\varnothing \leq 1/3W$</td> </tr> </tbody> </table> <p>Total acceptable quantity: 1 defect per segment Pin holes with \varnothing under 0.10 mm are acceptable</p>	Acceptable quantity		Width	\varnothing	$W \leq 0.4$	$\varnothing \leq 0.2$ and $\varnothing \leq 1/2W$	$W > 0.4$	$\varnothing \leq 0.25$ and $\varnothing \leq 1/3W$																				
Acceptable quantity																														
Width	\varnothing																													
$W \leq 0.4$	$\varnothing \leq 0.2$ and $\varnothing \leq 1/2W$																													
$W > 0.4$	$\varnothing \leq 0.25$ and $\varnothing \leq 1/3W$																													
Minor	Segment deformation	<p>1b. Pin hole on dot matrix display</p>  <table border="1" style="margin-left: auto; margin-right: auto;"> <thead> <tr> <th colspan="2">Acceptable quantity</th> </tr> <tr> <th>Size</th> <th></th> </tr> </thead> <tbody> <tr> <td>$a, b < 0.1$</td> <td>Any number</td> </tr> <tr> <td>$(a+b)/2 \leq 0.1$</td> <td>Any number</td> </tr> <tr> <td>$0.5 < \varnothing < 1.0$</td> <td>3</td> </tr> </tbody> </table> <p>Total acceptable quantity: 7</p> <p>2. Segments / dots with different width</p>  <table border="1" style="margin-left: auto; margin-right: auto;"> <thead> <tr> <th colspan="2">Acceptable</th> </tr> </thead> <tbody> <tr> <td>$a \geq b$</td> <td>$a/b \leq 4/3$</td> </tr> <tr> <td>$a < b$</td> <td>$a/b > 4/3$</td> </tr> </tbody> </table> <p>3. Alignment layer defect</p> <p>$\varnothing = (a+b)/2$</p>  <table border="1" style="margin-left: auto; margin-right: auto;"> <thead> <tr> <th colspan="2">Acceptable quantity</th> </tr> <tr> <th>Size</th> <th></th> </tr> </thead> <tbody> <tr> <td>$\varnothing \leq 0.4$</td> <td>Any number</td> </tr> <tr> <td>$0.4 < \varnothing \leq 1.0$</td> <td>5</td> </tr> <tr> <td>$1.0 < \varnothing \leq 1.5$</td> <td>3</td> </tr> <tr> <td>$1.5 < \varnothing \leq 2.0$</td> <td>2</td> </tr> </tbody> </table> <p>Total acceptable quantity: 7</p>	Acceptable quantity		Size		$a, b < 0.1$	Any number	$(a+b)/2 \leq 0.1$	Any number	$0.5 < \varnothing < 1.0$	3	Acceptable		$a \geq b$	$a/b \leq 4/3$	$a < b$	$a/b > 4/3$	Acceptable quantity		Size		$\varnothing \leq 0.4$	Any number	$0.4 < \varnothing \leq 1.0$	5	$1.0 < \varnothing \leq 1.5$	3	$1.5 < \varnothing \leq 2.0$	2
Acceptable quantity																														
Size																														
$a, b < 0.1$	Any number																													
$(a+b)/2 \leq 0.1$	Any number																													
$0.5 < \varnothing < 1.0$	3																													
Acceptable																														
$a \geq b$	$a/b \leq 4/3$																													
$a < b$	$a/b > 4/3$																													
Acceptable quantity																														
Size																														
$\varnothing \leq 0.4$	Any number																													
$0.4 < \varnothing \leq 1.0$	5																													
$1.0 < \varnothing \leq 1.5$	3																													
$1.5 < \varnothing \leq 2.0$	2																													
Minor	Colour uniformity	Level of sample for approval set as limit sample																												
Critical	Backlight	The backlight colour should correspond to the product specification																												
Critical		Flashing and or unlit backlight is not allowed																												
Minor		Dust larger than 0.25 mm is not allowed																												
Major	COB	Exposed wire bond pad is not allowed																												
Major		Insufficient covering with resin is not allowed (wire bond line exposed)																												
Minor		Dust or bubble on the resin are not allowed																												

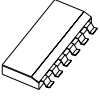
Class	Item	Criteria													
Major	 PCB	No unmelted solder paste should be present on PCB													
Critical		Cold solder joints, missing solder connections, or oxidation are not allowed													
Minor		No residue or solder balls on PCB are allowed													
Critical		Short circuits on components are not allowed													
Minor	Tray particles	<table border="1"> <thead> <tr> <th></th> <th>Size</th> <th>Quantity</th> </tr> </thead> <tbody> <tr> <td rowspan="2">On tray</td> <td>$\varnothing < 0.2$</td> <td>Any number</td> </tr> <tr> <td>$\varnothing > 0.25$</td> <td>4</td> </tr> <tr> <td rowspan="2">On display</td> <td>$\varnothing \geq 0.25$</td> <td>2</td> </tr> <tr> <td>L = 3</td> <td>1</td> </tr> </tbody> </table>		Size	Quantity	On tray	$\varnothing < 0.2$	Any number	$\varnothing > 0.25$	4	On display	$\varnothing \geq 0.25$	2	L = 3	1
		Size	Quantity												
On tray		$\varnothing < 0.2$	Any number												
		$\varnothing > 0.25$	4												
On display	$\varnothing \geq 0.25$	2													
	L = 3	1													

5.3 DEALING WITH CUSTOMER COMPLAINTS

5.3.1 Non-conforming analysis

Purchaser should supply Densitron with detailed data of non-conforming sample. After accepting it, Densitron should complete the analysis in two weeks from receiving the sample.

If the analysis cannot be completed on time, Densitron must inform the purchaser.

5.3.2 Handling of non-conforming displays

If any non-conforming displays are found during customer acceptance inspection which Densitron is clearly responsible for, return them to Densitron.

Both Densitron and customer should analyse the reason and discuss the handling of non-conforming displays when the reason is not clear.

Equally, both sides should discuss and come to agreement for issues pertaining to modification of Densitron quality assurance standard.

6 RELIABILITY SPECIFICATION

6.1 RELIABILITY TESTS

Test Item	Test Condition	Evaluation and assessment
High Temperature Operation	70°C±2°C, 240 HR	No abnormalities in function* and appearance
Low Temperature Operation	-20°C±2°C, 240 HR	No abnormalities in function* and appearance
High Temperature Storage	80°C±2°C, 240 HR	No abnormalities in function* and appearance
Low Temperature Storage	-30°C±2°C, 240 HR	No abnormalities in function* and appearance
Thermal Shock Storage	-30°C (30 min)->25°C (5 min) ->80°C (30 min)->25°C (5 min) 5 cycles	No abnormalities in function* and appearance
Vibration	10 Hz~55Hz 0.3mm / 1 Octave 55 Hz~500 Hz 3g / 1 Octave 20 cycles per axis	No abnormalities in function* and appearance

6.2 LIFE TIME

Item	Description
1	Function, performance, appearance, etc. shall be free from remarkable deterioration within 50,000 hours under ordinary operating and storage conditions of room temperature (25±10 °C), normal humidity (45±20% RH), and in area not exposed to direct sunlight.

7 PART NUMBER DESCRIPTIONS FOR AVAILABLE OPTIONS

LMR2048①②**2C16**③④⑤⑥

- ① **Polarizer Type**
B = Transflective: light background no backlight
- ② **Not applicable- LEAVE BLANK**
- ③ **Fluid Type and Power Supply**
H = STN-H with +5VDC
- ④ **Fluid Type**
N = STN-H
- ⑤ **Background Color for NTN**
G = Gray background
- ⑥ **Supply Voltage**
/3=3VDC Supply Voltage
/5 = 5VDC Supply Voltage

8 HANDLING PRECAUTIONS

Safety

If the LCD panel breaks, be careful not to get the liquid crystal fluid in your mouth or in your eyes. If the liquid crystal touches your skin or clothes, wash it off immediately using soap and plenty of water.

Mounting and Design

Place a transparent plate (e.g. acrylic, polycarbonate or glass) on the display surface to protect the display from external pressure. Leave a small gap between the transparent plate and the display surface. When assembling with a zebra connector, clean the surface of the pads with alcohol and keep the surrounding air very clean. Design the system so that no input signal is given unless the power supply voltage is applied.

Caution during LCD cleaning

Lightly wipe the display surface with a soft cloth soaked with Isopropyl alcohol, Ethyl alcohol or Trichlorotrifluoroethane. Do not wipe the display surface with dry or hard materials that will damage the polariser surface. Do not use aromatic solvents (toluene and xylene), or ketonic solvents (ketone and acetone).

Caution against static charge

As the display uses C-MOS LSI drivers, connect any unused input terminal to VDD or VSS. Do not input any signals before power is turned on.

Also, ground your body, work/assembly table and assembly equipment to protect against static electricity.

Packaging

Displays use LCD elements, and must be treated as such. Avoid strong shock and drop from a height. To prevent displays from degradation, do not operate or store them exposed directly to sunshine or high temperature/humidity.

Caution during operation

It is indispensable to drive the display within the specified voltage limit since excessive voltage shortens its life. Direct current causes an electrochemical reaction with remarkable deterioration of the display quality. Give careful consideration to prevent direct current during ON/OFF timing and during operation. Response time is extremely delayed at temperatures lower than the operating temperature range while, at high temperatures, displays become dark. However, this phenomenon is reversible and does not mean a malfunction or a display that has been permanently damaged. If the display area is pushed on hard during operation, some graphics will be abnormally displayed but returns to a normal condition after turning off the display once. Even a small amount of condensation on the contact pads (terminals) can cause an electro-chemical reaction which causes missing rows and columns. Give careful attention to avoid condensation.

Storage

Store the display in a dark place where the temperature is $25^{\circ}\text{C} \pm 10^{\circ}\text{C}$ and the humidity below 50%RH. Store the display in a clean environment, free from dust, organic solvents and corrosive gases. Do not crash, shake or jolt the display (including accessories).