

# SKT 10



**Stud Thyristor**

## Line Thyristor

### SKT 10

#### Features

- Hermetic metal case with glass insulator
- Threaded stud ISO M5
- International standard case

#### Typical Applications

- DC motor control (e. g. for machine tools)
- Controlled rectifiers (e. g. for battery charging)
- AC controllers (e. g. for temperature control)
- Recommended snubber network  
e.g. for  $V_{VRMS} \leq 400$  V:  
 $R = 100 \Omega/5$  W,  $C = 0,1 \mu F$

$V_{RSM}$ V	$V_{RRM}, V_{DRM}$ V	$I_{TRMS} = 30$ A (maximum value for continuous operation) $I_{TAV} = 10$ A (sin. 180; $T_c = 111$ °C)	
700	600	SKT 10/06D	
900	800	SKT 10/08D	
1300	1200	SKT 10/12E	

Symbol	Conditions	Values	Units
$I_{TAV}$	sin. 180; $T_c = 100$ (85) °C	14 (19)	A
$I_D$	K9; $T_a = 45$ °C; B2 / B6	12 / 16,5	A
	K5; $T_a = 45$ °C; B2 / B6	17 / 24	A
$I_{RMS}$	K9; $T_a = 45$ °C; W1C	13	A
$I_{TSM}$	$T_{vj} = 25$ °C; 10 ms	250	A
	$T_{vj} = 130$ °C; 10 ms	210	A
$i^2t$	$T_{vj} = 25$ °C; 8,35 ... 10 ms	310	A <sup>2</sup> s
	$T_{vj} = 130$ °C; 8,35 ... 10 ms	220	A <sup>2</sup> s
$V_T$	$T_{vj} = 25$ °C; $I_T = 30$ A	max. 1,6	V
$V_{T(TO)}$	$T_{vj} = 130$ °C	max. 1	V
$r_T$	$T_{vj} = 130$ °C	max. 18	mΩ
$I_{DD}, I_{RD}$	$T_{vj} = 130$ °C; $V_{RD} = V_{RRM}, V_{DD} = V_{DRM}$	max. 4	mA
$t_{gd}$	$T_{vj} = 25$ °C; $I_G = 1$ A; $di_G/dt = 1$ A/μs	1	μs
$t_{gr}$	$V_D = 0,67 * V_{DRM}$	2	μs
$(di/dt)_{cr}$	$T_{vj} = 125$ °C	max. 50	A/μs
$(dv/dt)_{cr}$	$T_{vj} = 125$ °C; SKT ...D / SKT ...E	max. 500 / 1000	V/μs
$t_q$	$T_{vj} = 130$ °C	80	μs
$I_H$	$T_{vj} = 25$ °C; typ. / max.	80 / 150	mA
$I_L$	$T_{vj} = 25$ °C; typ. / max.	150 / 300	mA
$V_{GT}$	$T_{vj} = 25$ °C; d.c.	min. 3	V
$I_{GT}$	$T_{vj} = 25$ °C; d.c.	min. 100	mA
$V_{GD}$	$T_{vj} = 130$ °C; d.c.	max. 0,25	V
$I_{GD}$	$T_{vj} = 130$ °C; d.c.	max. 3	mA
$R_{th(j-c)}$	cont.	1,2	K/W
$R_{th(j-c)}$	sin. 180	1,3	K/W
$R_{th(j-c)}$	rec. 120	1,35	K/W
$R_{th(c-s)}$		1	K/W
$T_{vj}$		- 40 ... + 130	°C
$T_{stg}$		- 40 ... + 150	°C
$V_{isol}$		-	V~
$M_s$	to heatsink	2,0	Nm
$a$		5 * 9,81	m/s <sup>2</sup>
$m$	approx.	7	g
Case		B 1	



**SKT**

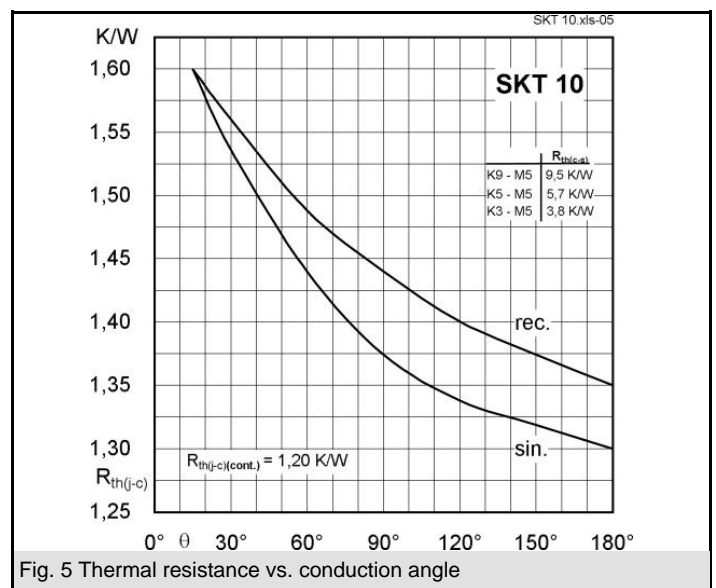
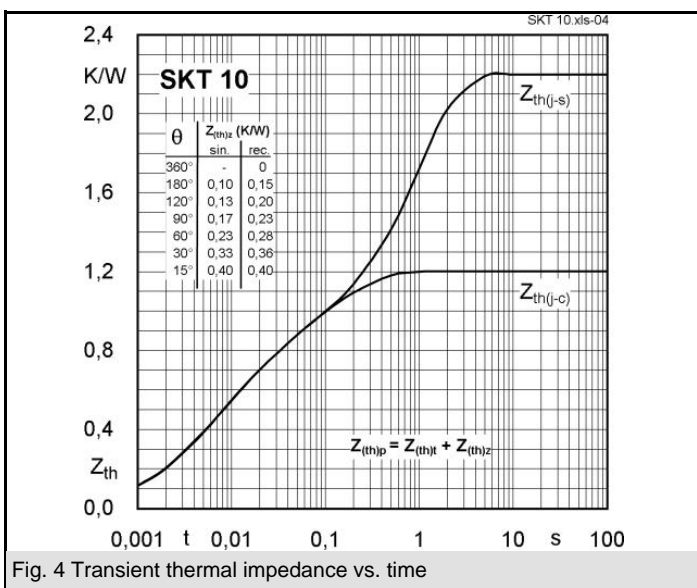
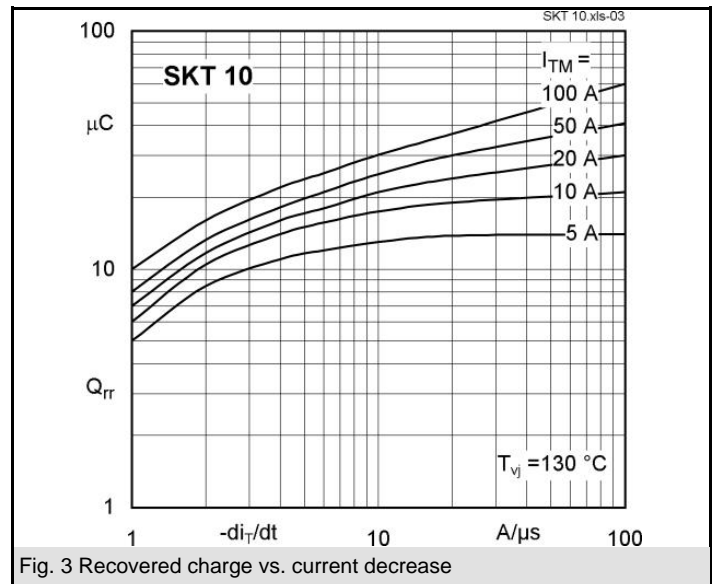
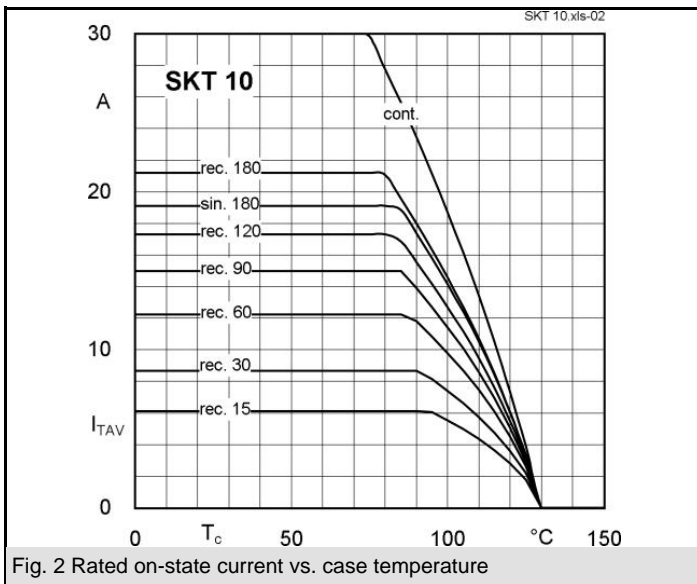
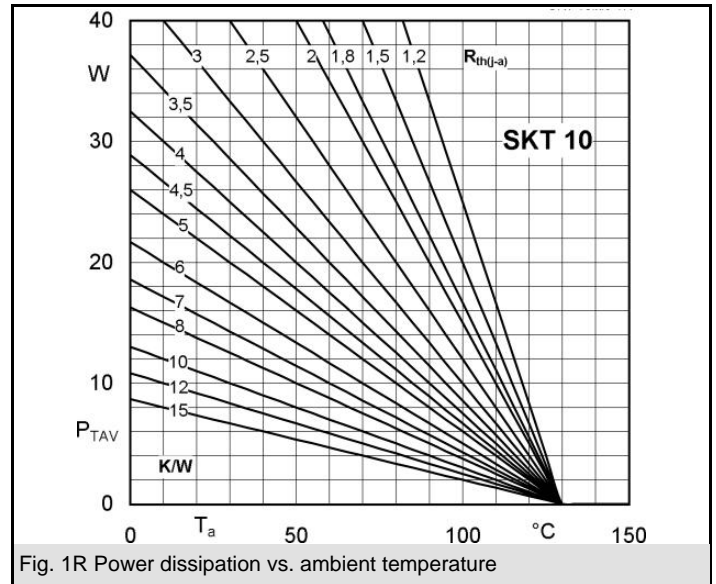
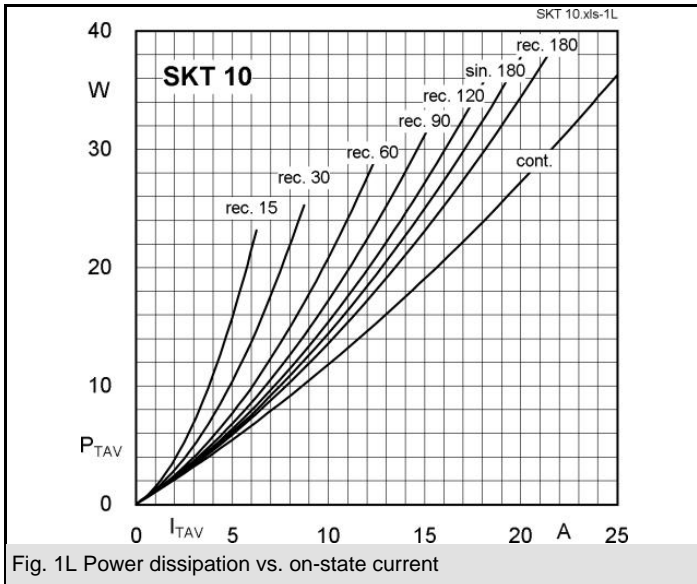

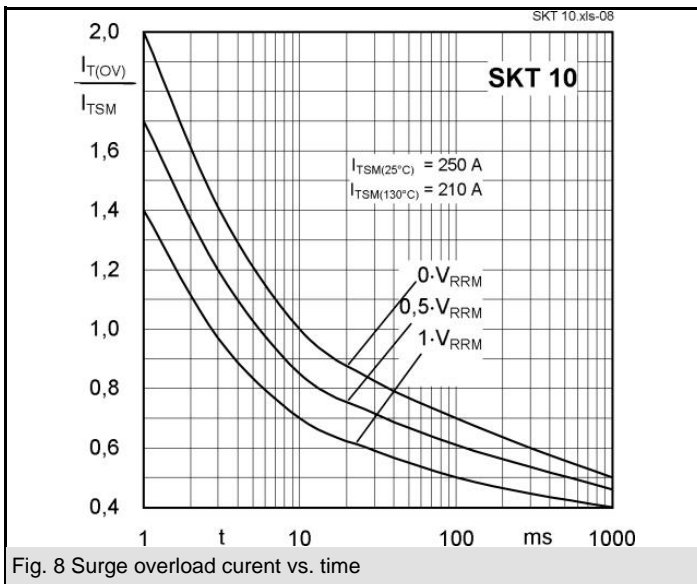
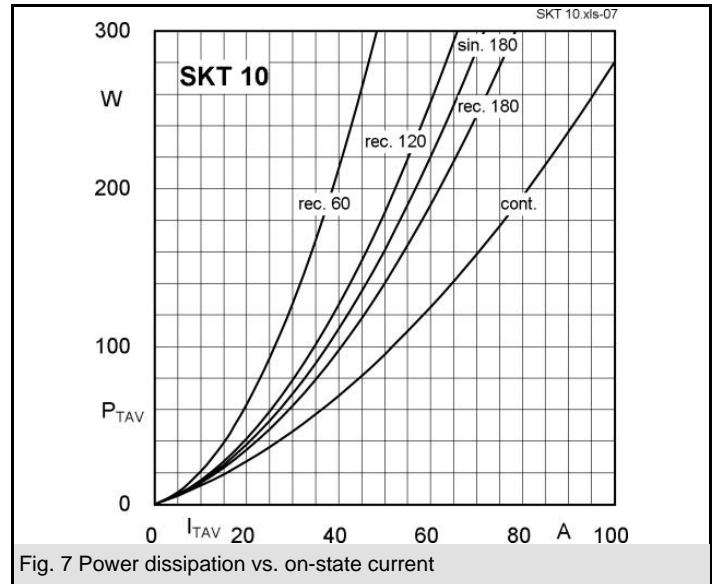
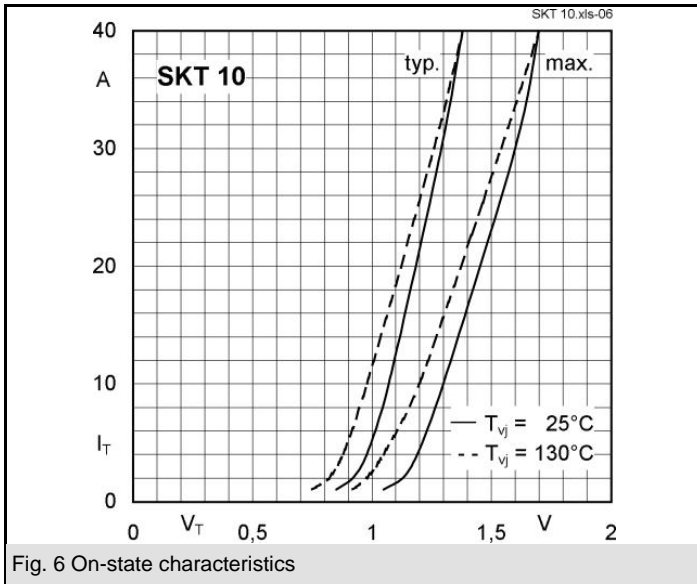

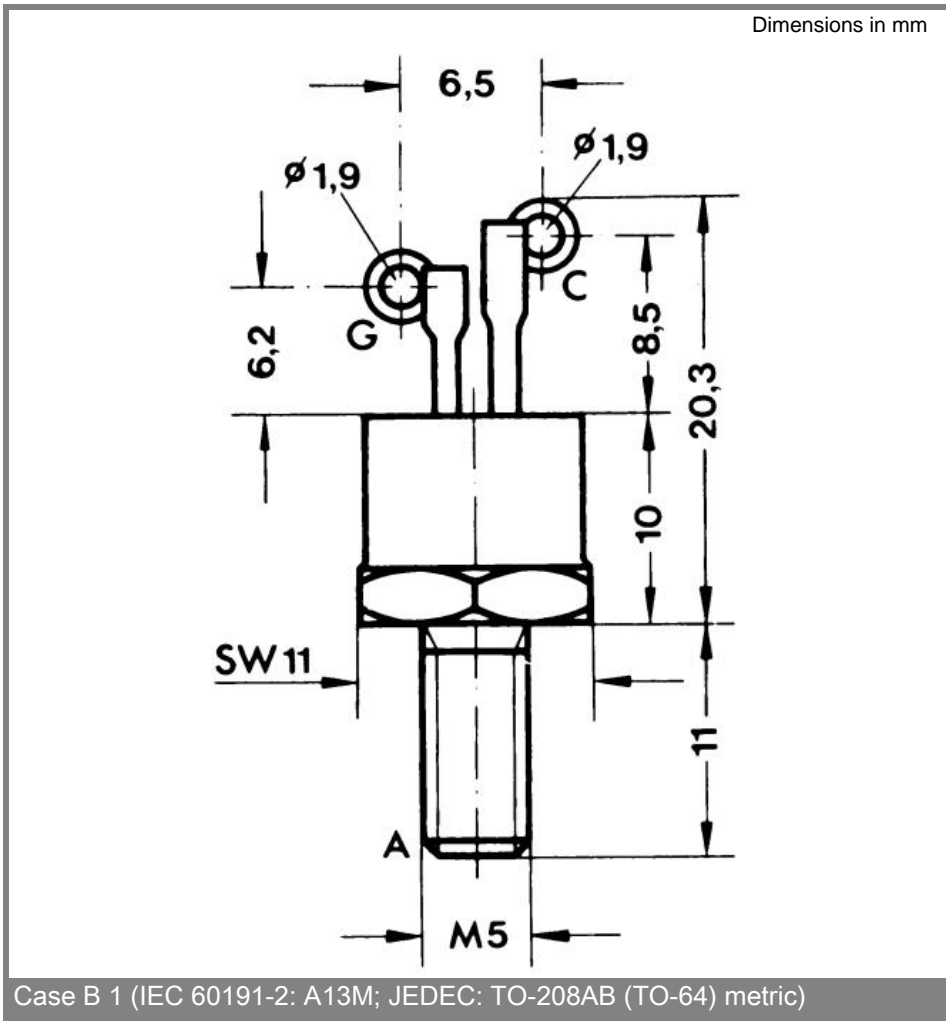
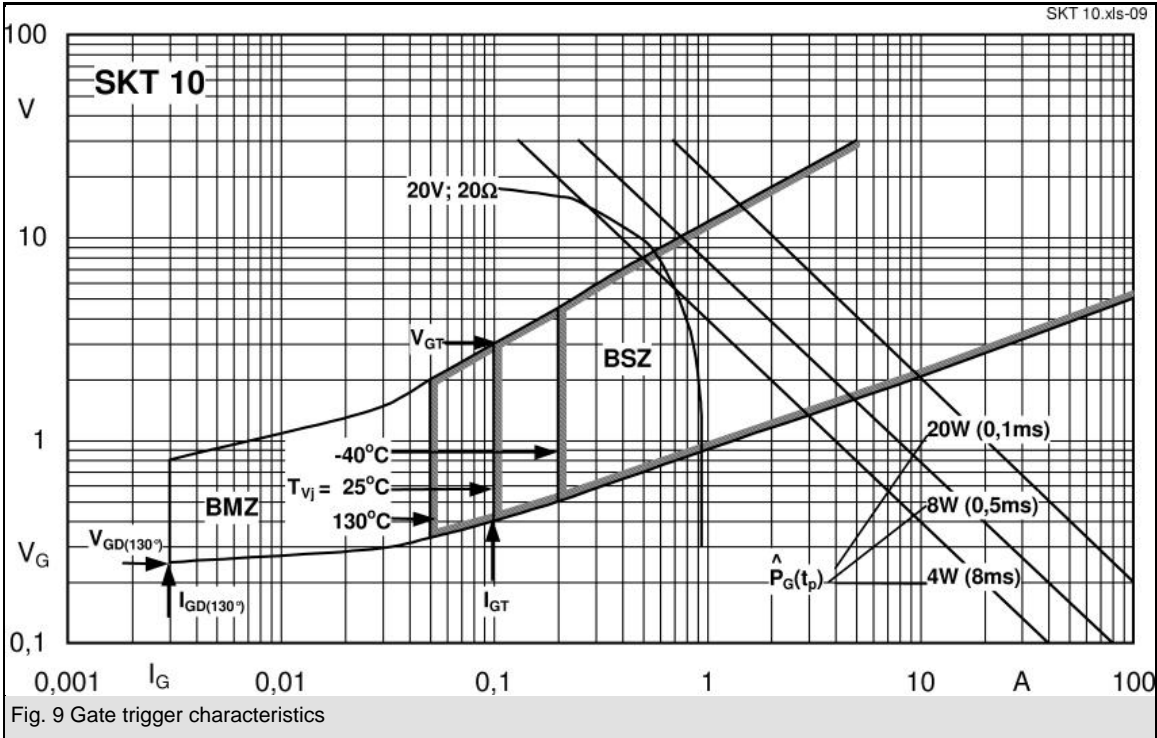

This technical information specifies semiconductor devices but promises no characteristics. No warranty or guarantee expressed or implied is made regarding delivery, performance or suitability.