

LIQUID CRYSTAL DISPLAY MODULE

Product Specification

CUSTOMER	Standard
CUSTOMER PART NUMBER	
PRODUCT NUMBER	DET040WVNMNT0S-2A

Product Mgr	Design Eng
Bruno Recaldini	Sunny
Date: 15-Nov-14	Date: 15-Nov-14

TABLE OF CONTENTS

1	MAIN FEATURES	4
2	MECHANICAL SPECIFICATION	5
2.1	MECHANICAL CHARACTERISTICS.....	5
2.2	MECHANICAL DRAWING.....	6
3	ELECTRICAL SPECIFICATION	7
3.1	ABSOLUTE MAXIMUM RATINGS.....	7
3.2	DC ELECTRICAL CHARACTERISTICS	7
3.3	INTERFACE PIN ASSIGNMENT	8
3.4	TIMING CHARACTERISTICS	10
3.5	RESET TIMING CHARACTERISTICS	13
4	OPTICAL SPECIFICATION	14
4.1	OPTICAL CHARACTERISTICS	14
5	BACKLIGHT SPECIFICATION	16
5.1	LED DRIVING CONDITIONS	16
5.2	LED CIRCUIT	16
6	QUALITY ASSURANCE SPECIFICATION	17
6.1	DELIVERY INSPECTION STANDARDS	17
6.2	DEALING WITH CUSTOMER COMPLAINTS.....	23
7	RELIABILITY SPECIFICATION	24
7.1	RELIABILITY TESTS.....	24
8	HANDLING PRECAUTIONS	25

REVISION RECORD

Rev.	Date	Page	Chapt.	Comment	ECN no.
1.0	15-Nov.-14			Initial Release	

1 MAIN FEATURES

ITEM	CONTENTS
Screen Size	4.0" Diagonal
Display Format	480 x RGB x 800 Dots
N° of Colour	65K/262K/16.7M
Active Area	51.84 mm (H) x 86.4 mm (V)
LCD Type	TFT
Mode	IPS Transmissive / Normally Black
Viewing Direction	Full view
Interface	3-SPI+ 16/18/24 RGB interface
Driver IC	ILI9806E
Backlight Type	LED
Operating Temperature	-20°C ~ +70°C
Storage Temperature	-30°C ~ +80°C
RoHS compliant	Yes

2 MECHANICAL SPECIFICATION

2.1 MECHANICAL CHARACTERISTICS

ITEM	CHARACTERISTIC	UNIT
Display Format	480 x RGB x 800 Dots	Dots
Overall Dimensions	58.26 mm (H) x 98.10 mm (V) x 2.2 mm (D)	mm
Active Area	51.84 mm (H) x 86.4 mm (V)	mm
pixel Pitch	0.108 (H) x 0.108 (V)	mm
Weight	20	G

2.2 MECHANICAL DRAWING

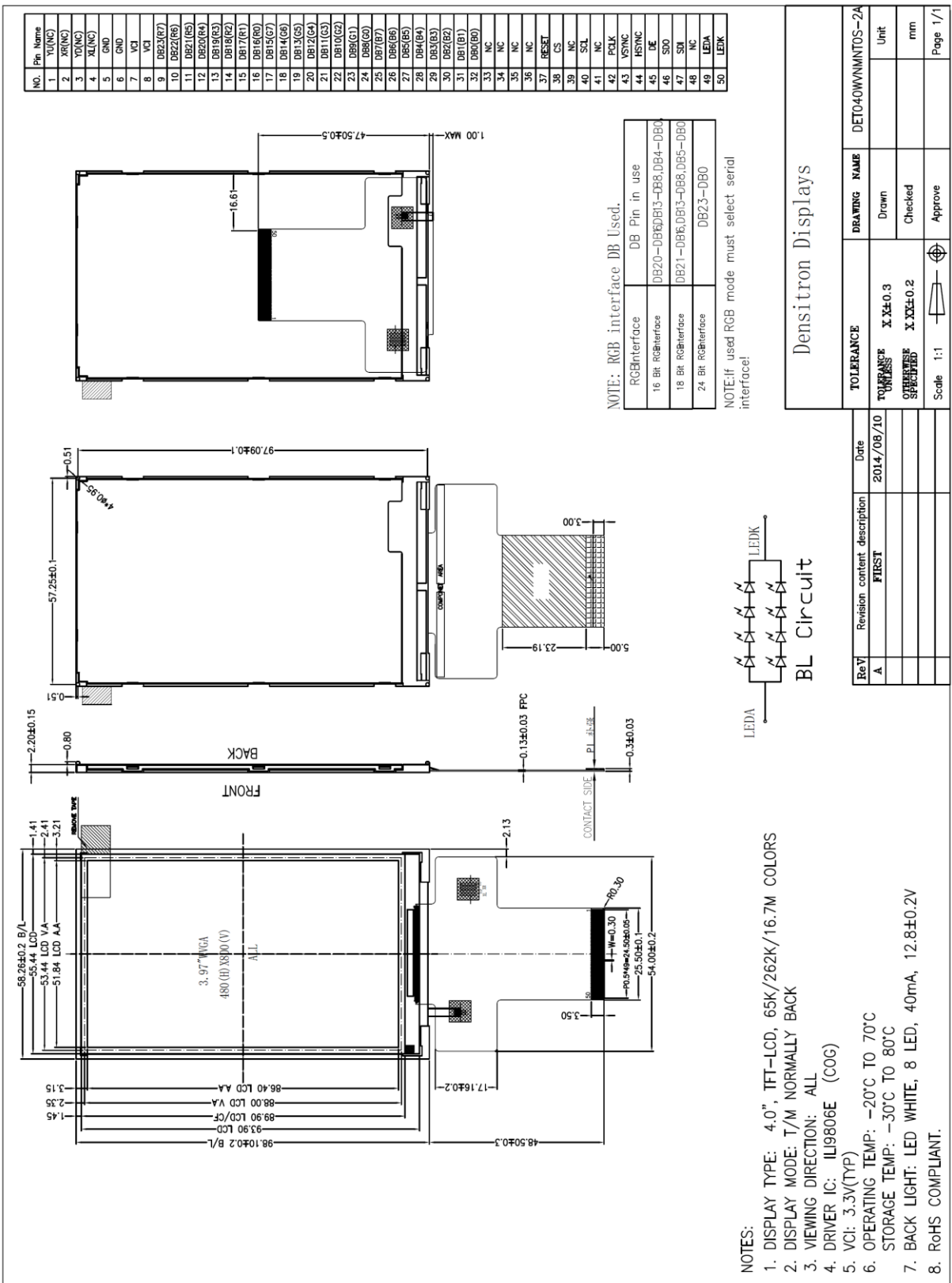

3 ELECTRICAL SPECIFICATION

3.1 ABSOLUTE MAXIMUM RATINGS

Item	Symbol	Condition	Min	Max	Unit	Note
Power Supply Voltage	VCI	Ta=25°C	-0.3	5.0	V	
Operating Temperature	TOP		-20	70	°C	1
Storage Temperature	TST		-30	80	°C	1,2,3

Note 1. 90 % RH Max for Ta<50 °C, and 60% RH for Ta≥50°C.

Note 2. In case of below 0°C, the response time of liquid crystal (LC) becomes slower and the colour of panel becomes darker than normal one. Level of retardation depends on temperature, because of LC's characteristic.

Note 3. Only operation is guaranteed at operating temperature. Contrast, response time, another display quality are evaluated at +25°C.

3.2 DC ELECTRICAL CHARACTERISTICS

Item	Symbol	Condition	Min	Typ	Max	Unit	Note
Supply Voltage	VCI		3.0	3.3	4.2	V	
Input Voltage for Logic	VIH		0.7VCI	-	VCI	V	
	VIL		GND	-	0.3VCI	V	
Output Voltage for Logic	VOH		VCI-0.4	-	-	V	
	VOL		GND	-	GND+0.4	V	
Current Consumption	ICC		-	30		mA	1

Note 1: The specified power consumption is under the conditions of VCI=3.3V, FV=60Hz.

3.3 INTERFACE PIN ASSIGNMENT

3.3.1 LCM PIN ASSIGNMENT

Pin NO.	Symbol	Function
1	YU (NC)	
2	XR (NC)	
3	YD (NC)	
4	XL (NC)	
5	GND	Ground
6	GND	
7	VCI	Analogue power supply, 3.3V.
8	VCI	
9-32	DB23-DB0	<p>Data bus PINS -RGB data bus used. 16-bit bus: use DB20-DB16,DB13-DB8,DB4-DB0 18-bit bus: use DB21-DB16,DB13-DB8,DB5-DB0 24-bit bus: use DB23-DB0 If not used PINS, please must connect to GND.</p>
33-36	NC	
37	RESET	Reset pin, Setting either pin low initializes the LSI. Must be rest after power is supplied.
38	CS	Chip select signal. Low: chip can be accessed; High: chip cannot be accessed.
39	NC	
40	SCL	Serial clock input

Pin NO.	Symbol	Function
41	NC	
42	PCLK	Dot clock signal
43	VSYNC	Frame synchronizing signal.
44	HSYNC	Frame synchronizing signal.
45	DE	Data enable signal.
46	SDO	Serial data output pin used for the SPI interface. Leave the pin to open when not in use.
47	SDI	Serial data input pin used for SPI interface
48	NC	NC
49	LEDA	Anode pin of backlight
50	LEDK	Cathode pin of backlight

3.4 TIMING CHARACTERISTICS

3.4.1 Display Serial Interface Timing Characteristics (3-line SPI system)

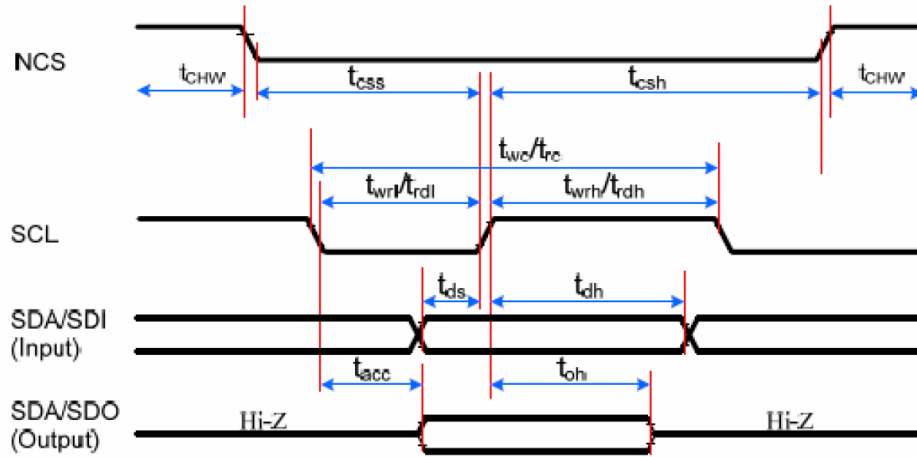

Signal	Symbol	Parameter	min	max	Unit	Description
CSX	t _{CSS}	Chip select time (Write)	15	-	ns	
	t _{CSH}	Chip select hold time (Read)	15	-	ns	
	t _{CHW}	CS "H" pulse width	40	-	ns	
SCL	t _{WC}	Serial clock cycle (Write)	30	-	ns	
	t _{WRH}	SCL "H" pulse width (Write)	10	-	ns	
	t _{WRL}	SCL "L" pulse width (Write)	10	-	ns	
	t _{RC}	Serial clock cycle (Read)	150	-	ns	
	t _{RDH}	SCL "H" pulse width (Read)	60	-	ns	
SDA/SDO (Output)	t _{ACC}	Access time (Read)	10	100	ns	For maximum CL=30pF
	t _{OH}	Output disable time (Read)	15	100	ns	For minimum CL=8pF
SDA/SDI (Input)	t _{DS}	Data setup time (Write)	10	-	ns	
	t _{DH}	Data hold time (Write)	10	-	ns	

Note:

1. Ta = -30 to 70 °C, IOVCC=1.65V to 3.6V, VCI=2.5V to 3.6V, T=10+/-0.5ns.
2. Does not include signal rise and fall times.

3.4.2 Parallel 24/18/16 – bit RGB Interface Timing Characteristics

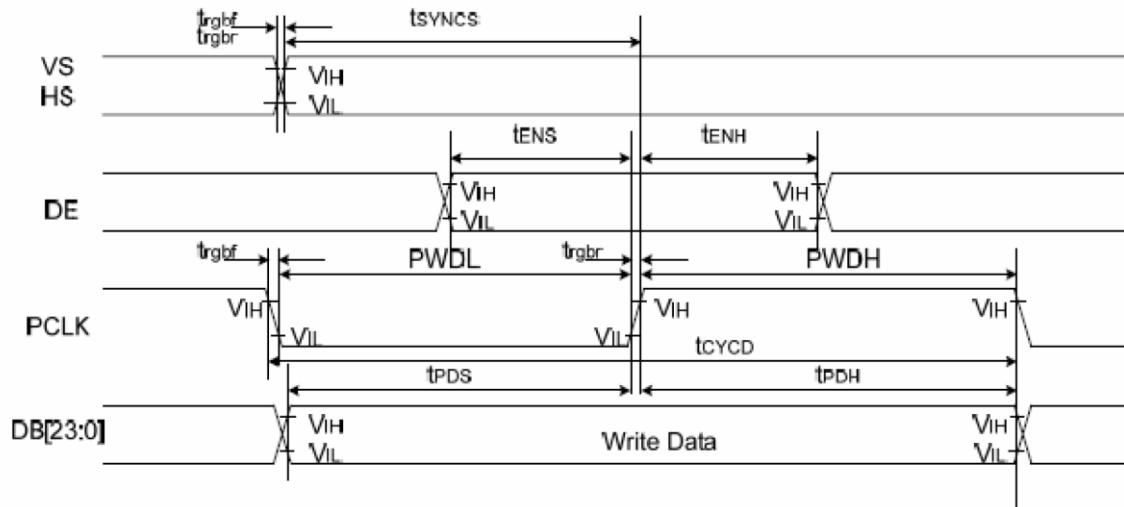

Signal	Symbol	Parameter	min	max	Unit	Description
VS/ HS	t_{SYNCS}	VS/HS setup time	5	-	ns	24/18/16-bit bus RGB interface mode
	t_{SYNCH}	VS/HS hold time	5	-	ns	
DE	t_{ENS}	DE setup time	5	-	ns	
	t_{ENH}	DE hold time	5	-	ns	
DB[23:0]	t_{POS}	Data setup time	5	-	ns	
	t_{PDH}	Data hold time	5	-	ns	
PCLK	PWDH	PCLK high-level period	13	-	ns	
	PWDL	PCLK low-level period	13	-	ns	
	t_{CYCD}	PCLK cycle time	28	-	ns	
	t_{rghf}, t_{rgbr}	PCLK,HS,VS rise/fall time	-	15	ns	

Note: $T_a = -30$ to 70 °C, $IOVCC=1.65V$ to $3.6V$, $VCI=2.5V$ to $3.6V$, $DGND=0V$

3.4.3 DPI interface Timing

The timing chart of 24-/18-/16-bit DPI (RGB) interface mode is illustrated in Figure.

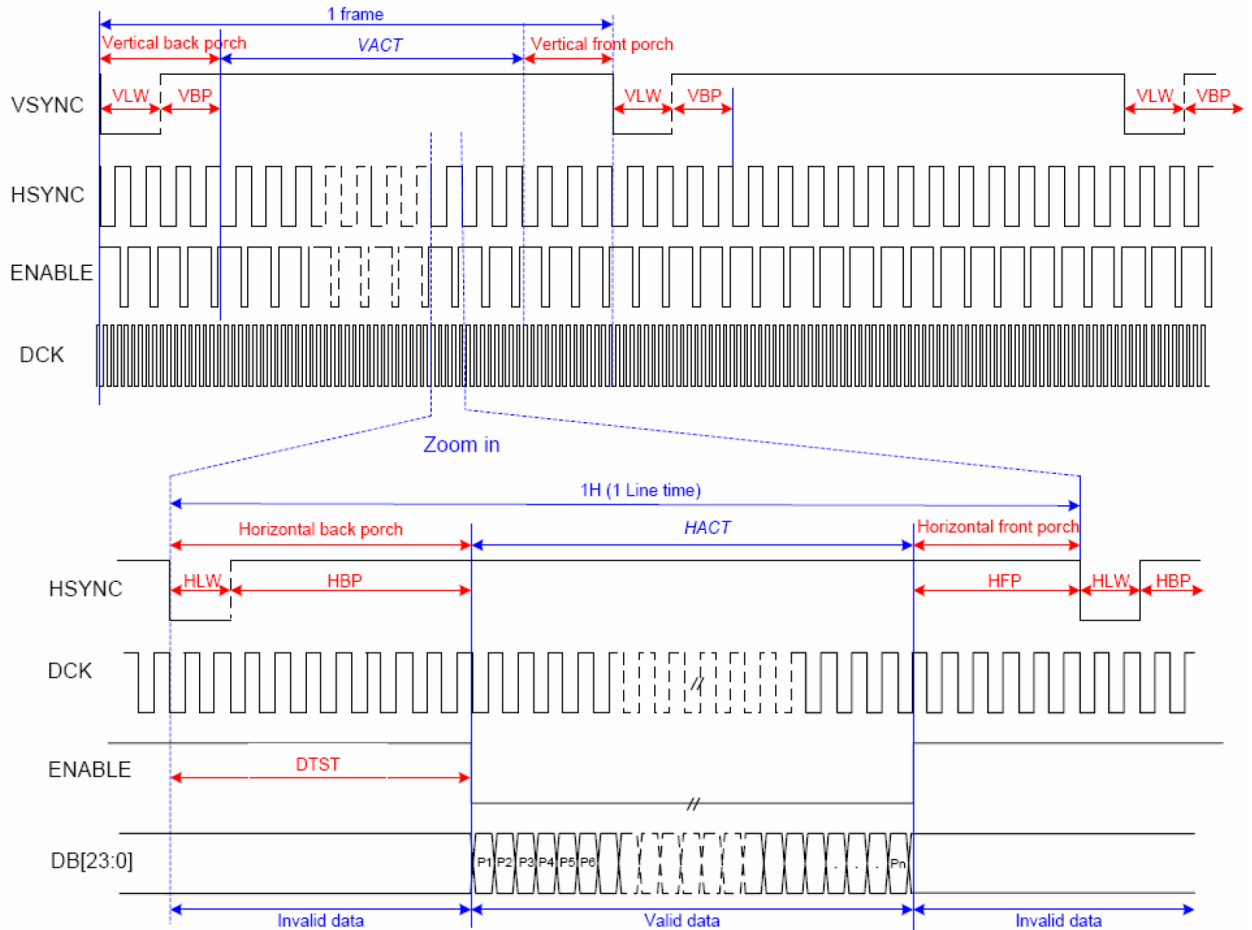

VLW : VSYNC Low pulse Width
 HLW : HSYNC Low pulse Width
 DTST : Data Transfer Startup Time
 Pn : pixel 1, pixel 2..., pixel n.

Parameter	Symbols	Condition	Min.	Typ.	Max.	Units
Frame Rate	FR		54		66	fps
Horizontal Low Pulse width	HLW		1		-	DOTCLK
Horizontal Back Porch	HBP		2		126	DOTCLK
Horizontal Address	HACT			480		DOTCLK
Horizontal Front Porch	HFP		2		-	DOTCLK
Vertical Low Pulse width	VLW		1		126	Line
Vertical Back Porch	VBP		1		126	Line
Vertical Address	VACT				864	Line
Vertical Front Porch	VFP		1		255	Line
Data Clock	DCLK		16.6		41.7	MHz

3.5 RESET TIMING CHARACTERISTICS

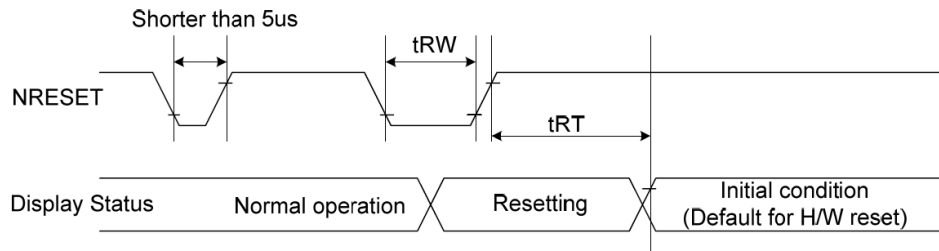

Figure 102 Reset Timing

Table 41 Reset Timing

Signal	Symbol	Parameter	Min	Max	Unit
RESX	tRW	Reset pulse duration	10		us
	tRT	Reset cancel		5(note 1,5) 120 (note 1,6,7)	ms

Note:

1. The reset cancel includes also required time for loading ID bytes, VCOM setting and other settings from OTP to registers. This loading is done every time when there is H/W reset cancel time (tRT) within 5 ms after a rising edge of RESX.
2. Spike due to an electrostatic discharge on RESX line does not cause irregular system reset according to the Table 43.

Table 42 Reset Descript

RESX Pulse	Action
Shorter than 5us	Reset Rejected
Longer than 9us	Reset
Between 5us and 9us	Reset starts

3. During the Resetting period, the display will be blanked (The display is entering blanking sequence, which maximum time is 120 ms, when Reset Starts in Sleep Out mode. The display remains the blank state in Sleep In mode.) and then return to Default condition for Hardware Reset.
4. Spike Rejection also applies during a valid reset pulse as shown below:

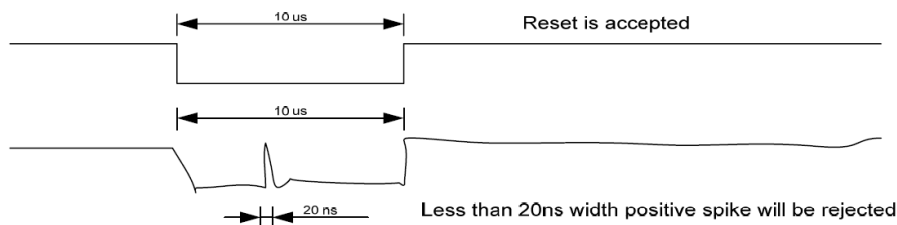

Figure 103 Positive Noise Pulse during Reset Low

5. When Reset applied during Sleep In Mode.
6. When Reset applied during Sleep Out Mode.
7. It is necessary to wait 5msec after releasing RESX before sending commands. Also Sleep Out command cannot be sent for 120msec.

4 OPTICAL SPECIFICATION

4.1 OPTICAL CHARACTERISTICS

Driving condition: VCI = 3.3V, VSS = 0V
 Backlight: IF=20mA
 Measured temperature: Ta = 25° C

Item	Symbol	Condition	MIN	TYP	MAX	Unit	Note
Response Time	TR+TF	$\theta=\phi=0^\circ$ Normal Viewing Angle	-	35	-	ms	2
Contrast Ratio	CR		550	800	-		3
Viewing Angle	Left	CR ≥ 10	80	85	-	deg	4
	Right		80	85	-	deg	
	Up		80	85	-	deg	
	Down		80	85	-	deg	
Colour Chromaticity	Red	Rx	0.650	0.665	0.680	-	5
		Ry	0.308	0.323	0.338	-	
	Green	Gx	0.257	0.272	0.287	-	
		Gy	0.573	0.588	0.613	-	
	Blue	Bx	0.119	0.134	0.149	-	
		By	0.106	0.121	0.136	-	
	White	Wx	0.277	0.292	0.307	-	
		Wy	0.318	0.333	0.348	-	
Centre Brightness		If=40mA	350		-	cd/m ²	6
Brightness Distribution			80	-	-	%	7

4.1.1 Test Method

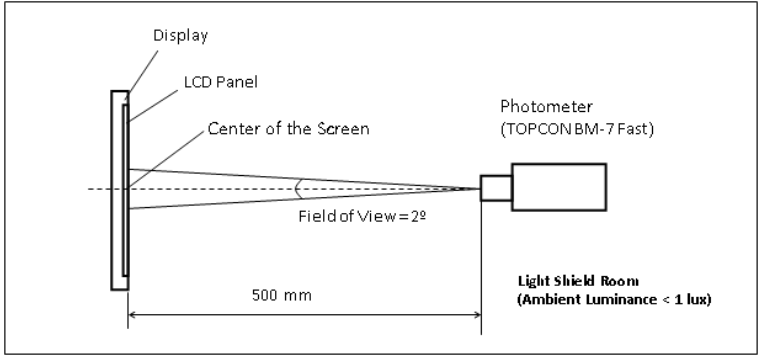
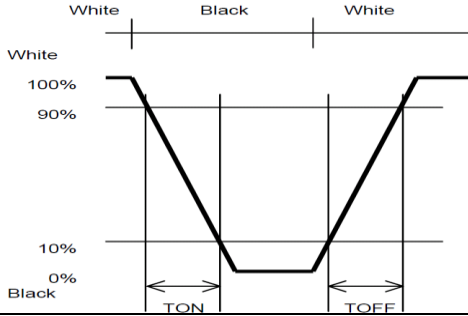
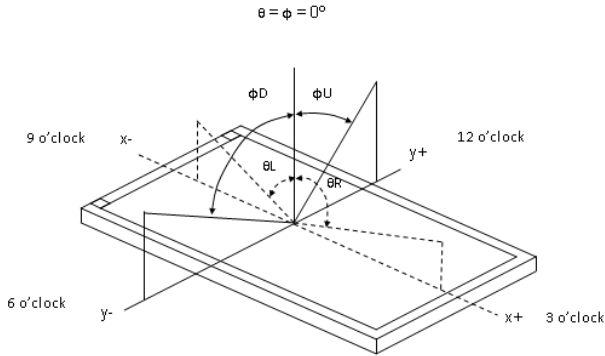
Note	Item	Test method
1	Setup	<p>The display should be stabilised at a given temperature for 30 minutes to avoid abrupt temperature change during measuring. In order to stabilise the luminance, measurements should be executed after lighting the backlight for 30 minutes in a windless room.</p> 
2	Response time	<p>Measure output signal waveform by the luminance meter when raster of window pattern is changed from white to black and from black to white.</p> 
3	Contrast ratio	<p>Measure maximum brightness and minimum brightness at the centre of the screen by displaying raster or window pattern. Then calculate the ratio between these two values.</p> $\text{Contrast Ratio (CR)} = \frac{\text{Brightness of unselected position (white)}}{\text{Brightness of selected position (black)}}$
4	Viewing angle Horizontal θ Vertical ϕ	<p>Move the luminance meter from right to left and up and down and determinate the angles where contrast ratio is 10</p> 
5	Colour chromaticity	Measure chromaticity coordinates x and y of CIE1931 colorimetric system
6	Centre brightness	Measure the brightness at the centre of the screen
7	Brightness distribution	<p>(Brightness distribution)= 100 x B/A % A: max. brightness of the 9 points B: min. brightness of the 9 points</p>

5 BACKLIGHT SPECIFICATION

5.1 LED DRIVING CONDITIONS

The back light system is edge-lighting type with 8 chips White LED

Item	Symbol	Condition	Min	Typ	Max	Unit
Forward Current	IF	Ta=25 °C,	30	40	-	mA
Forward Voltage	VF	Ta= 25°C,	-	12.8	-	V

Note:

- The lifetime of the LED is defined as a period till the brightness of the LED decreases to the half of its initial value.
- This figure is given as a reference purpose only, and not a guarantee.
- This figure is estimated for an LED operating alone.
The performance of an LED may differ when assembled as a monitor together with a TFT panel due to different environmental temperature.
- Estimated lifetime could vary on a different temperature and usually higher temperature could reduce the life significantly.

5.2 LED CIRCUIT



6 QUALITY ASSURANCE SPECIFICATION

6.1 DELIVERY INSPECTION STANDARDS

6.1.1 Inspection Conditions

Inspection distance: 30 cm ± 2 cm
Viewing angle: ±45°

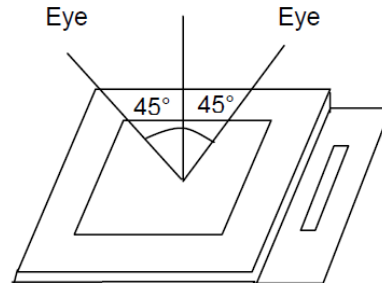

6.1.2 Environmental Conditions

Ambient temperature: 23°C ±5°C
Ambient humidity: 55±10% RH
Ambient illumination: 1000~1500 lux

6.1.3 Sampling Conditions

1. Lot size: quantity of shipment lot per model
2. Sampling method:

Sampling Plan		ANSI / ASQC Z1.4-1993
		Normal inspection, Single Sampling
AQL	Major Defect	0.65%
	Minor Defect	1.5%

6.1.4 Definition of Area

A zone: active area
B zone: viewing area

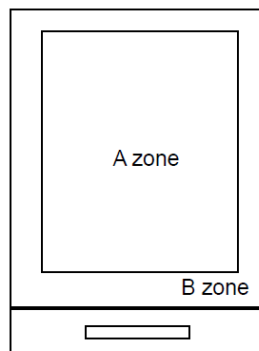

6.1.5 Basic Principle

A set of sample to indicate the limit of acceptable quality level shall be discussed should a dispute occur.

6.1.6 Inspection Criteria

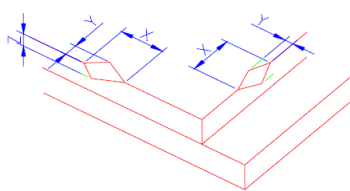
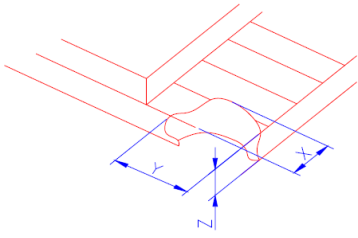
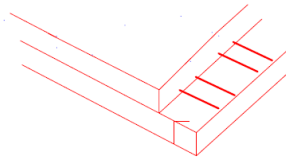
Number	Items	Criteria(mm)						
1.0 LCD Crack/Broken	(1) The edge of LCD broken	 <table border="1" data-bbox="845 638 1332 784"> <thead> <tr> <th>X</th> <th>Y</th> <th>Z</th> </tr> </thead> <tbody> <tr> <td>≤3.0mm</td> <td><Inner border line of the seal</td> <td>≤T</td> </tr> </tbody> </table>	X	Y	Z	≤3.0mm	<Inner border line of the seal	≤T
X	Y	Z						
≤3.0mm	<Inner border line of the seal	≤T						
T: Height of LCD	(2)LCD corner broken	 <table border="1" data-bbox="901 1232 1276 1321"> <thead> <tr> <th>X</th> <th>Y</th> <th>Z</th> </tr> </thead> <tbody> <tr> <td>≤3.0mm</td> <td>≤L</td> <td>≤T</td> </tr> </tbody> </table>	X	Y	Z	≤3.0mm	≤L	≤T
	X	Y	Z					
≤3.0mm	≤L	≤T						
(3) LCD crack	 <p>Crack Not allowed</p>							

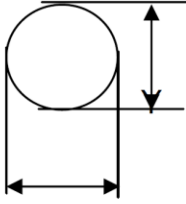
<p>Spot defect</p>  <p>X</p> <p>$\Phi = (X+Y)/2$</p>	<p>① light dot (LCD/TP/Polarizer black/white spot , light dot, pinhole, dent, stain)</p> <table border="1"> <thead> <tr> <th rowspan="2">Zone Size (mm)</th> <th colspan="3">Acceptable Qty</th> </tr> <tr> <th>A</th> <th>B</th> <th>C</th> </tr> </thead> <tbody> <tr> <td>$\Phi \leq 0.10$</td> <td colspan="3">Ignore</td> </tr> <tr> <td>$0.10 < \Phi \leq 0.15$</td> <td colspan="3">3(distance $\geq 10\text{mm}$)</td> </tr> <tr> <td>$0.15 < \Phi \leq 0.2$</td> <td colspan="3">1</td> </tr> <tr> <td>$0.2 < \Phi$</td> <td colspan="3">0</td> </tr> </tbody> </table>	Zone Size (mm)	Acceptable Qty			A	B	C	$\Phi \leq 0.10$	Ignore			$0.10 < \Phi \leq 0.15$	3(distance $\geq 10\text{mm}$)			$0.15 < \Phi \leq 0.2$	1			$0.2 < \Phi$	0				
	Zone Size (mm)		Acceptable Qty																							
		A	B	C																						
	$\Phi \leq 0.10$	Ignore																								
	$0.10 < \Phi \leq 0.15$	3(distance $\geq 10\text{mm}$)																								
$0.15 < \Phi \leq 0.2$	1																									
$0.2 < \Phi$	0																									
<p>② Dim spot (LCD/TP/Polarizer dim dot, light leakage, dark spot)</p> <table border="1"> <thead> <tr> <th rowspan="2">Zone Size (mm)</th> <th colspan="3">Acceptable Qty</th> </tr> <tr> <th>A</th> <th>B</th> <th>C</th> </tr> </thead> <tbody> <tr> <td>$\Phi \leq 0.1$</td> <td colspan="3">Ignore</td> </tr> <tr> <td>$0.1 < \Phi \leq 0.2$</td> <td colspan="3">2(distance $\geq 10\text{mm}$)</td> </tr> <tr> <td>$0.2 < \Phi \leq 0.3$</td> <td colspan="3">1</td> </tr> <tr> <td>$\Phi > 0.3$</td> <td colspan="3">0</td> </tr> </tbody> </table>	Zone Size (mm)	Acceptable Qty			A	B	C	$\Phi \leq 0.1$	Ignore			$0.1 < \Phi \leq 0.2$	2(distance $\geq 10\text{mm}$)			$0.2 < \Phi \leq 0.3$	1			$\Phi > 0.3$	0					
Zone Size (mm)		Acceptable Qty																								
	A	B	C																							
$\Phi \leq 0.1$	Ignore																									
$0.1 < \Phi \leq 0.2$	2(distance $\geq 10\text{mm}$)																									
$0.2 < \Phi \leq 0.3$	1																									
$\Phi > 0.3$	0																									
<p>③ Polarizer accidented spot</p> <table border="1"> <thead> <tr> <th rowspan="2">Zone Size (mm)</th> <th colspan="3">Acceptable Qty</th> </tr> <tr> <th>A</th> <th>B</th> <th>C</th> </tr> </thead> <tbody> <tr> <td>$\Phi \leq 0.2$</td> <td colspan="3">Ignore</td> </tr> <tr> <td>$0.2 < \Phi \leq 0.5$</td> <td colspan="3">2(distance $\geq 10\text{mm}$)</td> </tr> <tr> <td>$\Phi > 0.5$</td> <td colspan="3">0</td> </tr> </tbody> </table>	Zone Size (mm)	Acceptable Qty			A	B	C	$\Phi \leq 0.2$	Ignore			$0.2 < \Phi \leq 0.5$	2(distance $\geq 10\text{mm}$)			$\Phi > 0.5$	0									
Zone Size (mm)		Acceptable Qty																								
	A	B	C																							
$\Phi \leq 0.2$	Ignore																									
$0.2 < \Phi \leq 0.5$	2(distance $\geq 10\text{mm}$)																									
$\Phi > 0.5$	0																									
<p>Line defect (LCD/TP /Polarizer black/white line, scratch, stain)</p> <table border="1"> <thead> <tr> <th rowspan="2">Width(mm)</th> <th rowspan="2">Length(mm)</th> <th colspan="3">Acceptable Qty</th> </tr> <tr> <th>A</th> <th>B</th> <th>C</th> </tr> </thead> <tbody> <tr> <td>$\Phi \leq 0.03$</td> <td>Ignore</td> <td colspan="2">Ignore</td> <td rowspan="3">Ignore</td> </tr> <tr> <td>$0.03 < W \leq 0.05$</td> <td>$L \leq 3.0$</td> <td colspan="2">$N \leq 2$</td> </tr> <tr> <td>$0.05 < W \leq 0.08$</td> <td>$L \leq 2.0$</td> <td colspan="2">$N \leq 2$</td> </tr> <tr> <td>$0.08 < W$</td> <td colspan="4">Define as spot defect</td> </tr> </tbody> </table>	Width(mm)	Length(mm)	Acceptable Qty			A	B	C	$\Phi \leq 0.03$	Ignore	Ignore		Ignore	$0.03 < W \leq 0.05$	$L \leq 3.0$	$N \leq 2$		$0.05 < W \leq 0.08$	$L \leq 2.0$	$N \leq 2$		$0.08 < W$	Define as spot defect			
Width(mm)			Length(mm)	Acceptable Qty																						
	A	B		C																						
$\Phi \leq 0.03$	Ignore	Ignore		Ignore																						
$0.03 < W \leq 0.05$	$L \leq 3.0$	$N \leq 2$																								
$0.05 < W \leq 0.08$	$L \leq 2.0$	$N \leq 2$																								
$0.08 < W$	Define as spot defect																									

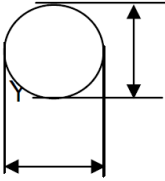
Items	Criteria (mm)																																																																	
<p>Spot defect</p>  <p>X</p> <p>$\Phi = (X+Y)/2$</p>	<p>① light dot (LCD/TP/Polarizer black/white spot , light dot, pinhole, dent, stain)</p> <table border="1" data-bbox="391 685 1225 999"> <thead> <tr> <th rowspan="2">Zone Size (mm)</th> <th colspan="3">Acceptable Qty</th> </tr> <tr> <th>A</th> <th>B</th> <th>C</th> </tr> </thead> <tbody> <tr> <td>$\Phi \leq 0.10$</td> <td colspan="3">Ignore</td> </tr> <tr> <td>$0.10 < \Phi \leq 0.15$</td> <td colspan="3">3(distance $\geq 10\text{mm}$)</td> </tr> <tr> <td>$0.15 < \Phi \leq 0.2$</td> <td colspan="3">1</td> </tr> <tr> <td>$0.2 < \Phi$</td> <td colspan="3">0</td> </tr> </tbody> </table> <p>② Dim spot (LCD/TP/Polarizer dim dot, light leakage、dark spot)</p> <table border="1" data-bbox="391 1084 1246 1402"> <thead> <tr> <th rowspan="2">Zone Size (mm)</th> <th colspan="3">Acceptable Qty</th> </tr> <tr> <th>A</th> <th>B</th> <th>C</th> </tr> </thead> <tbody> <tr> <td>$\Phi \leq 0.1$</td> <td colspan="3">Ignore</td> </tr> <tr> <td>$0.1 < \Phi \leq 0.2$</td> <td colspan="3">2(distance $\geq 10\text{mm}$)</td> </tr> <tr> <td>$0.2 < \Phi \leq 0.3$</td> <td colspan="3">1</td> </tr> <tr> <td>$\Phi > 0.3$</td> <td colspan="3">0</td> </tr> </tbody> </table> <p>③ Polarizer accidented spot</p> <table border="1" data-bbox="391 1487 1121 1760"> <thead> <tr> <th rowspan="2">Zone Size (mm)</th> <th colspan="3">Acceptable Qty</th> </tr> <tr> <th>A</th> <th>B</th> <th>C</th> </tr> </thead> <tbody> <tr> <td>$\Phi \leq 0.2$</td> <td colspan="3">Ignore</td> </tr> <tr> <td>$0.2 < \Phi \leq 0.5$</td> <td colspan="3">2(distance $\geq 10\text{mm}$)</td> </tr> <tr> <td>$\Phi > 0.5$</td> <td colspan="3">0</td> </tr> </tbody> </table>	Zone Size (mm)	Acceptable Qty			A	B	C	$\Phi \leq 0.10$	Ignore			$0.10 < \Phi \leq 0.15$	3(distance $\geq 10\text{mm}$)			$0.15 < \Phi \leq 0.2$	1			$0.2 < \Phi$	0			Zone Size (mm)	Acceptable Qty			A	B	C	$\Phi \leq 0.1$	Ignore			$0.1 < \Phi \leq 0.2$	2(distance $\geq 10\text{mm}$)			$0.2 < \Phi \leq 0.3$	1			$\Phi > 0.3$	0			Zone Size (mm)	Acceptable Qty			A	B	C	$\Phi \leq 0.2$	Ignore			$0.2 < \Phi \leq 0.5$	2(distance $\geq 10\text{mm}$)			$\Phi > 0.5$	0		
Zone Size (mm)	Acceptable Qty																																																																	
	A	B	C																																																															
$\Phi \leq 0.10$	Ignore																																																																	
$0.10 < \Phi \leq 0.15$	3(distance $\geq 10\text{mm}$)																																																																	
$0.15 < \Phi \leq 0.2$	1																																																																	
$0.2 < \Phi$	0																																																																	
Zone Size (mm)	Acceptable Qty																																																																	
	A	B	C																																																															
$\Phi \leq 0.1$	Ignore																																																																	
$0.1 < \Phi \leq 0.2$	2(distance $\geq 10\text{mm}$)																																																																	
$0.2 < \Phi \leq 0.3$	1																																																																	
$\Phi > 0.3$	0																																																																	
Zone Size (mm)	Acceptable Qty																																																																	
	A	B	C																																																															
$\Phi \leq 0.2$	Ignore																																																																	
$0.2 < \Phi \leq 0.5$	2(distance $\geq 10\text{mm}$)																																																																	
$\Phi > 0.5$	0																																																																	



Line defect (LCD/TP /Polarizer black/white line, scratch, stain)	Width(mm)	Length(mm)	Acceptable Qty		
			A	B	C
	$\Phi \leq 0.03$	Ignore	Ignore		Ignore
	$0.03 < W \leq 0.05$	$L \leq 3.0$	$N \leq 2$		
	$0.05 < W \leq 0.08$	$L \leq 2.0$	$N \leq 2$		
$0.08 < W$	Define as spot defect				

Polarizer Bubble	Zone	Acceptable Qty		
	Size (mm)	A	B	C
	$\Phi \leq 0.2$	Ignore		Ignore
	$0.2 < \Phi \leq 0.4$	2(distance ≥ 10 mm)		
	$0.4 < \Phi \leq 0.6$	1		
$0.6 < \Phi$	0			

SMT	According to IPC-A-610C class II standard . Function defect and missing part are major defect ,the others are minor defect.		
-----	-----------------------------------------------------------------------------------------------------------------------------	--	--

TP bubble/ accidented spot	Size Φ (mm)	Acceptable Qty		
		A	B	C
	$\Phi \leq 0.1$	Ignore		Ignore
	$0.1 < \Phi \leq 0.2$	2 (distance ≥ 10 mm)		
	$0.2 < \Phi \leq 0.3$	1		
$0.3 < \Phi$	0			

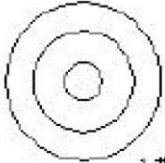
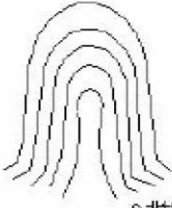
Assembly deflection	beyond the edge of backlight ≤ 0.15 mm		
------------------------	---------------------------------------------	--	--

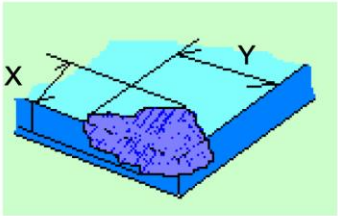
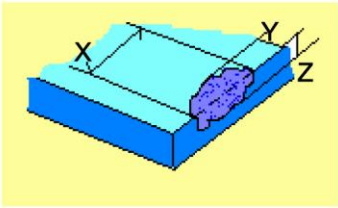
TP Related	Newton Ring	<p>Newton Ring area > 1/3 TP area NG</p> <p>Newton Ring area ≤ 1/3 TP area OK</p>	 1 规律性  2 非规律性  似牛顿环						
	TP corner broken X : length Y : width Z : height	<table border="1"> <tr> <td>X</td> <td>Y</td> <td>Z</td> </tr> <tr> <td>X ≤ 3.0mm</td> <td>Y ≤ 3.0mm</td> <td>Z < LCD thickness</td> </tr> </table> <p>* Circuitry broken is not allowed.</p>	X	Y	Z	X ≤ 3.0mm	Y ≤ 3.0mm	Z < LCD thickness	
	X	Y	Z						
X ≤ 3.0mm	Y ≤ 3.0mm	Z < LCD thickness							
TP edge broken X : length Y : width Z : height	<table border="1"> <tr> <td>X</td> <td>Y</td> <td>Z</td> </tr> <tr> <td>X ≤ 6.0mm</td> <td>Y ≤ 2.0mm</td> <td>Z < LCD thickness</td> </tr> </table> <p>* Circuitry broken is not allowed.</p>	X	Y	Z	X ≤ 6.0mm	Y ≤ 2.0mm	Z < LCD thickness		
X	Y	Z							
X ≤ 6.0mm	Y ≤ 2.0mm	Z < LCD thickness							

Number	Items	Criteria (mm)
1	No display	Not allowed
2	Missing segment	Not allowed
3	Short	Not allowed
4	Backlight no lighting	Not allowed
5	TP no function	Not allowed

6.1.7 Classification of Defects

Visual defects (except no or wrong label) are treated as minor defects, while electrical defects are treated as major defects.

Two minor defects are equal to one major defect in lot sampling inspection.

6.1.8 Identification / marking criteria

Any unit with illegible / wrong / double or no marking / label shall be rejected.

6.2 DEALING WITH CUSTOMER COMPLAINTS

6.2.1 Non-conforming analysis

Purchaser should supply Densitron with detailed data of non-conforming sample.

After accepting it, Densitron should complete the analysis in two weeks from receiving the sample.

If the analysis cannot be completed on time, Densitron must inform the purchaser.

6.2.2 Handling of non-conforming displays

If any non-conforming displays are found during customer acceptance inspection which Densitron is clearly responsible for, return them to Densitron.

Both Densitron and customer should analyse the reason and discuss the handling of non-conforming displays when the reason is not clear.

Equally, both sides should discuss and come to agreement for issues pertaining to modification of Densitron quality assurance standard.

7 RELIABILITY SPECIFICATION

7.1 RELIABILITY TESTS

Test Item		Test Condition	
Durability Test	High Temperature Storage	Ta= 80°C	96h
	Low Temperature Storage	Ta=-30°C	96h
	Temperature Cycle Storage	-20°C ←→ 70°C ON/OFF, 20 cycles. ON time over 10 seconds ,OFF time over 10 seconds	
	High Temperature Operation	Tp= 60°C	96h
	Low Temperature Operation	Tp= -20°C	96h
	High Temperature & Humidity Operation	Tp= 40°C RH= 90% 96h Non condensing	
	Thermal Shock Resistance	The sample should be allowed to stand the following 5 cycles of operation: TSTL for 30 minutes -> normal temperature for 5 minutes -> TSTH for 30 minutes -> normal temperature for 5 minutes, as one cycle, then taking it out and drying it at normal temperature, and allowing it stand for 24 hours	
	Box Drop Test	1 Corner 3 Edges 6 faces, 66 cm (Medium Box)	

Note: Ta=ambient temperature Tp= Panel temperature

Notes:

1. No dew condensation to be observed.
2. The function test shall be conducted after 4 hours storage at the normal temperature and humidity after removed from the test chamber.
3. No cosmetic or functional defects should be allowed.
4. Total current consumption should be less than twice the initial value.

8 HANDLING PRECAUTIONS

Safety

If the LCD panel breaks, be careful not to get the liquid crystal fluid in your mouth or in your eyes. If the liquid crystal touches your skin or clothes, wash it off immediately using soap and plenty of water.

Mounting and Design

Place a transparent plate (e.g. acrylic, polycarbonate or glass) on the display surface to protect the display from external pressure. Leave a small gap between the transparent plate and the display surface.

When assembling with a zebra connector, clean the surface of the pads with alcohol and keep the surrounding air very clean.

Design the system so that no input signal is given unless the power supply voltage is applied.

Caution during LCD cleaning

Lightly wipe the display surface with a soft cloth soaked with Isopropyl alcohol, Ethyl alcohol or Trichlorotrifluoroethane.

Do not wipe the display surface with dry or hard materials that will damage the polariser surface.

Do not use aromatic solvents (toluene and xylene), or ketonic solvents (ketone and acetone).

Caution against static charge

As the display uses C-MOS LSI drivers, connect any unused input terminal to VDD or VSS. Do not input any signals before power is turned on. Also, ground your body, work/assembly table and assembly equipment to protect against static electricity.

Packaging

Displays use LCD elements, and must be treated as such. Avoid strong shock and drop from a height. To prevent displays from degradation, do not operate or store them exposed directly to sunshine or high temperature/humidity.

Caution during operation

It is indispensable to drive the display within the specified voltage limit since excessive voltage shortens its life. Direct current causes an electrochemical reaction with remarkable deterioration of the display quality. Give careful consideration to prevent direct current during ON/OFF timing and during operation. Response time is extremely delayed at temperatures lower than the operating temperature range while, at high temperatures, displays become dark. However, this phenomenon is reversible and does not mean a malfunction or a display that has been permanently damaged. If the display area is pushed on hard during operation, some graphics will be abnormally displayed but returns to a normal condition after turning off the display once. Even a small amount of condensation on the contact pads (terminals) can cause an electro-chemical reaction which causes missing rows and columns. Give careful attention to avoid condensation.

Storage

Store the display in a dark place where the temperature is 25°C ± 10°C and the humidity below 50%RH. Store the display in a clean environment, free from dust, organic solvents and corrosive gases.

Do not crash, shake or jolt the display (including accessories).

Product No.	DET040WVNMNTOS-2A	REV. 1.0
-------------	-------------------	----------

Page	25 / 25
------	---------