

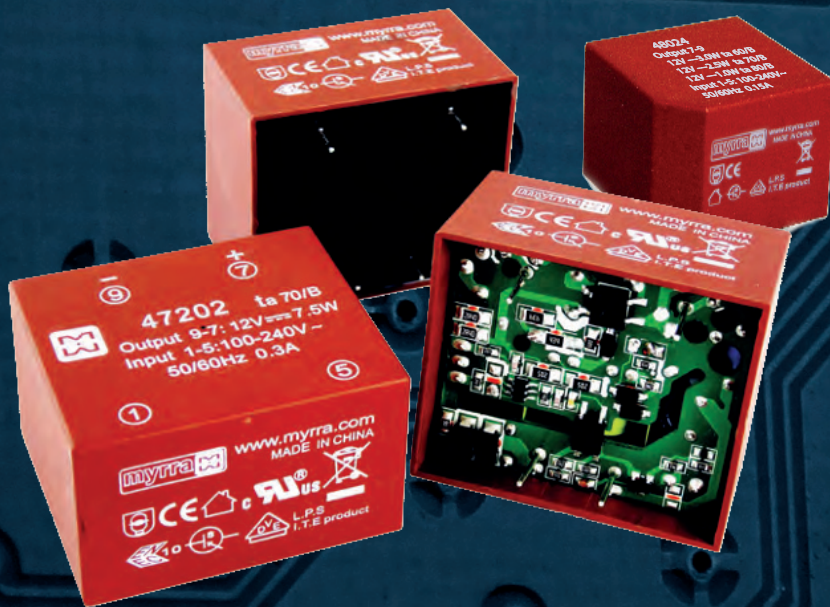

# ***ELECTRONICS TRANSFORMERS SWITCHING POWER SUPPLIES***



## ***47000 SERIES 48000 SERIES***

*A fully certified range of PCB mounting Power supplies  
from **1 W** up to **10 W***



Presenting the  
**Electronic  
 Transformers**

miniature power  
 supplies at your  
 fingertips

Enhanced efficiency, performance & flexibility

full certification from global authorities     

**Encapsulated Power Supplies 1W to 10W**

Regulated, unregulated, single & dual output voltage families

**Serie 47000**

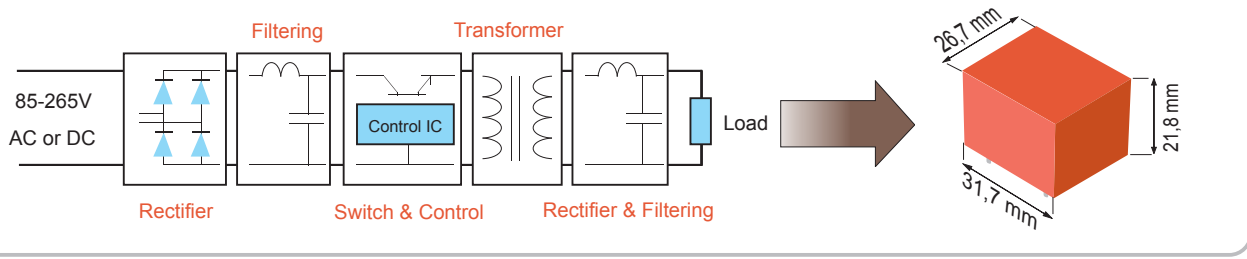

**Serie 48000**

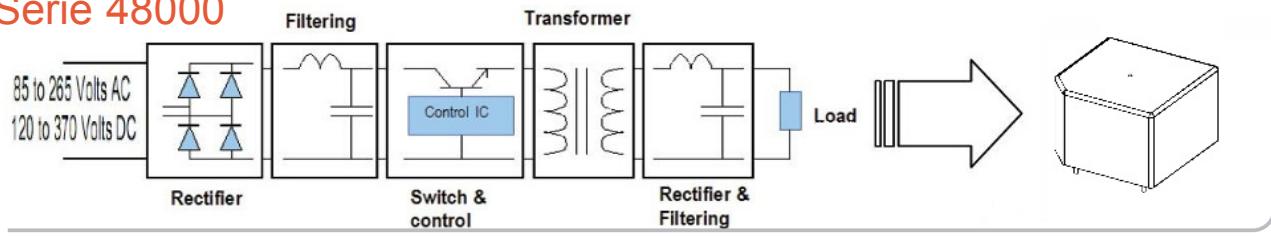

# ELECTRONIC TRANSFORMERS

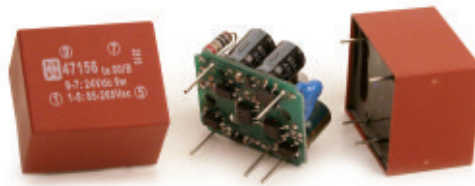

MYRRA encapsulated electronic transformers are Switched Mode Power Supplies based on Flyback topology.

They constitute an interesting alternative to the traditional supply in the most common applications of power from 1W to 10W

**ENERGY SAVING** due to high efficiency and low standby power



## MAIN FEATURES

- Wide input voltage range
- Increased power. 3 x compared to standard EI30, EI38 and EI48 transformer (47000 series)
- Better energetic efficiency : 70% typical compared to 40% for the conventional supply
- Very low Standby Power consumption: meets requirements of Energy Star or EC Code of Conduct
- Same footprint as EI30, EI38 and EI48 transformer : 47000 series upgrade your application without redesign of PCB
- 48000 series Unique : 3 Power/Ambient ratings from 1W to 3W

## Power from 1W to 10W

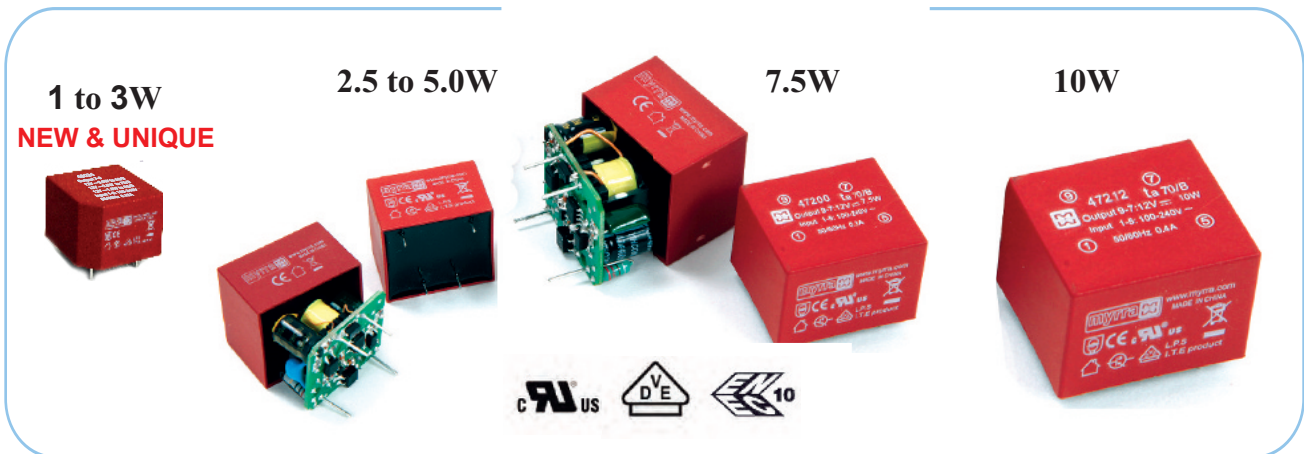

The applications for the Electronic serie are :

- Alternative to the linear transformers in all AC/DC applications of power up to 10W
- Alternative to DC/DC converters for application in D.C.current (Telecom supplies, electric substations etc.)
- Industrial, domestic and consumer electronics applications
- Standby devices and others DC or AC auxiliary supplies

they will replace:

- 50 Hz Transformer
- Fuse
- Bridge Rectifier
- Filtering Capacitor

Regulated types will also replace linear regulator and heatsink

## SAFETY STANDARDS APPROVALS:

- EN 60950
- EN 60335
- EN 61558-1
- EN 61558-2-16
- UL 60950-1
- CSA 22.2 N°60950-1
- UL 94V0

## EMC STANDARDS

Conducted and radiated emissions conform to

- EN 55014-1
- EN 55022 class B

Immunity conform to

- EN 55014-2
- EN 61000-4-x

# SINGLE OUTPUT Regulated 1.0 to 3 W



## MAIN FEATURES :

- Unique 3 Power/Ambient Ratings from 1W to 3W
- Single Primary Regulated DC Output
- Output Range : 3.3VDC - 24VDC
- Input Range : 85VAC - 265VAC/47 - 63Hz or 120VDC - 370VDC
- Very Low Standby Power Consumption < 0.15W
- Safety : IEC/EN61558-2-16, IEC/EN60950, IEC/EN60335, UL/CUL60950, CE, VDE, ENEC Mark
- EMC : Compliant & Certified
- Meet Requirements of Energy stars and EC Code Of Conduct
- Enclosed, encapsulated construction
- Materials : Uses UL 94-V0 Plastic And Resin



Part No	Power Rating Watts	Output Voltage (VDC)	Output Current (mA)	Ambient Temp. (°C)	Efficiency Typical	Input Range
48021	2.75	3.3	830	50	>63%@230VAC	85VAC-265VAC (120VDC-370VDC)
	2.5		750	60		
	1.0		300	80		
48022	3.0	5.0	600	50	>65%@230VAC	
	2.5		500	60		
	1.0		200	80		
48023	3.0	9.0	330	60	>70%@230VAC	
	2.5		280	70		
	1.0		110	80		
48024	3.0	12	250	60	>72%@230VAC	
	2.5		210	70		
	1.0		84	80		
48025	3.0	15	200	60	>72%@230VAC	
	2.5		170	70		
	1.0		67	80		
48026	3.0	18	170	60	>72%@230VAC	
	2.5		140	70		
	1.0		56	80		
48027	3.0	24	125	60	>74%@230VAC	
	2.5		105	70		
	1.0		42	80		

Note: Other output voltages are available upon request.

## DIMENSIONS and PINOUT

4 PINS

PRI. Pins 1 – 5: AC Or DC Input  
SEC. Pin 7 : DC Output +V  
Pin 9 : DC Output 0V

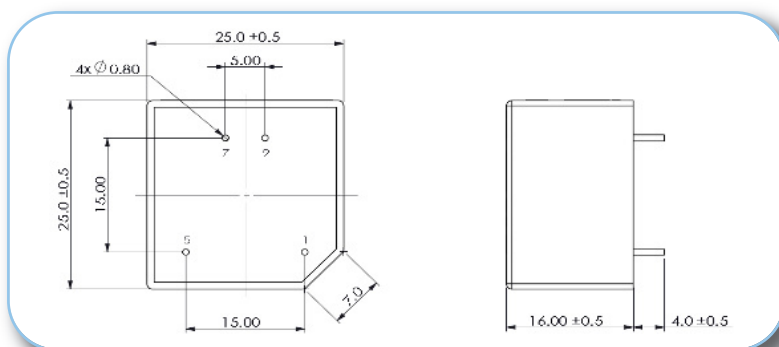

Power Derating Curve

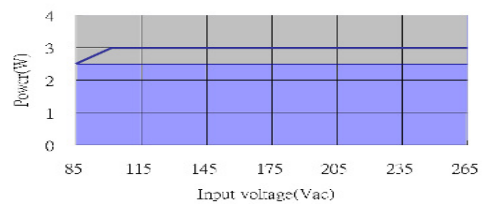

Power Derating Curve

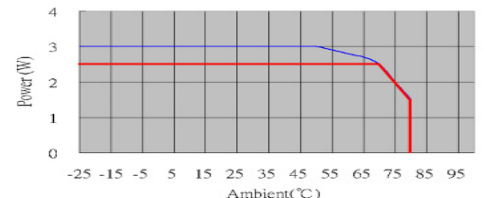

# SINGLE OUTPUT Regulated 1.0 to 3 W



Model: 2.5 Watt		Specification
AC Input Characteristics	Rated AC input Voltage	100~240Vac or 140VDC-340VDC
	AC Input Voltage Range	85~265Vac or 120VDC-370VDC
	AC Input Frequency Range	47Hz~63Hz
	Rated AC Input Frequency	50/60Hz
	Input Current	0.15A Max@85Vac~265Vac, at full load
	Standby Power	0.15W Max(Meet Requirements Of Energy Star And EC Code Of Conduct)
DC Output Characteristics	Output Voltage Accuracy	± 5%
	Output Voltage Line Regulation	3.3V type: ± 5 %      Other types(5V,9V,12V,15V,18V and 24V): ± 3 %
	Output Voltage Load Reg.	± 5%
	Ripple & Noise	Max 200mVp-p@ Rated AC input, at nominal line (The measuring will be terminated with a 47uF AL E-Cap and a 0.1uF Ceramic-Cap. An oscilloscope set at 20MHz bandwidth)
	Dynamic Response	The output voltage shall not exceed ±10% rated output voltage @ 50%←→100% Load change, 1A/uS , 1KHz 50% duty cycle
	Hold Up Time	5mS min@ 100Vac ~240Vac, DC output with full load
	Turn On Delay	3S max @ 85Vac~265Vac input and DC output with full load
	Rise Time	50ms max @ 85Vac~265Vac input and DC output with full load
	Overshoot	The output voltage shall not exceed +10% rated output voltage @ Power on and 85Vac~265Vac input, and DC with full load
	Undershoot	The output voltage shall not exceed -10% rated output voltage @ Power off and 85Vac~265Vac input and DC output with full load
	Efficiency	See table (Meets Requirements Of Energy Star And EC Code Of Conduct)
Protection Characteristics	Over Current Protection	The power supply shall automatic protect. The power supply shall auto-recover normal operation after the deformation is removed. No excessive heat, odor, or plastic deformation shall occur with no safety hazard
	Output Short Circuit Protection	The power supply shall withstand a continuous output short without damage in 24 hours; The short may be applied before power on, or after power on; The power supply shall resume normal operation after the short is removed, no excessive heat, odor, or plastic deformation shall occur with no safety hazard
	Over temperature protection	The power supply shall shut down when the junction temperature of PWM controller exceeds the thermal shutdown temperature, typically 140°C ±10°C.
Environmental	Operation Temperature	-25°C ~+ (see table)
	Operation Humidity	10~ 90% RH(No Condensing) @ full load
	Storage Temperature	-40°C~ +85°C
	Storage Humidity	5%~95%
	Cooling Method	Ordinary or thermostat
Safety & EMC Requirement	Dielectric Strength	Primary to Secondary: 4000Vac 5mA, 3 secs.
	Radiation	Meet EN55022,EN55014,FCC, part 15, Class B. under 3dB margin
	Conduction	Meet EN55022,EN55014, FCC, part 15,Class B. under 3dB margin
	Lightning Surge	EN61000-4-5:2014,±1KV (surge level can be extended to 6KV with an external circuit - please refer to MYRRA's website and catalogue for MYRRA SMPS application notes).
	Safety Standards	Meet all requirements of UL/CUL60950 IEC/EN60950 IEC/EN60335 IEC/EN61558-2-16 CE,VDE, ENEC Mark
Reliability Requirement	MTBF	Calculated by MIL-HDBK-217-F2 >200K Hours @230VAC input at max operation temperature; >550K Hours @230VAC input at 25deg.C
	Burn-In Test	The unit shall be burned in for 2~ 5hours under 230Vac input and DC with full load at an ambient temperature of 30~45 degrees C
Net Weight	About 16 grams per product unit	
Guarantee	This product meets RoHS standard	

**MAIN FEATURES :**

- 2.5 To 5W Small Compact Size - PCB Mount
- Single Output - Regulated
- Output Range : 3.3VDC - 24VDC
- Input Range : 85VAC - 265VAC/47 - 63Hz Or 120VDC - 370VDC
- Very Low Standby Power Consumption < 0.2W
- Better Energetic Efficiency : Meet Requirements Of Energy Star And EC Code Of Conduct
- Encapsulated Design And Same Footprint As EI30 Transformer: Upgrade Your Application Without Redesign Of PCB
- Safety : Meets All Requirements of: IEC/EN61558-2-16, IEC/EN60950, IEC/EN60335, UL/CUL60950, CE, VDE, ENEC Mark
- Materials : Uses UL 94-V0 Plastic And Resin
- EMC : Conducted And Radiated Emissions Conform To EN55014 , EN55022, CLASS B
- Immunity Conform To EN61000-3-3, EN61000-4-2, EN61000-4-3, EN61000-4-4, EN61000-4-5, EN61000-4-6, EN61000-4-8, EN61000-4-11



**CERTIFIED !**

Reference	Output voltage (DC Volts)	Output current (DC mA)	Output Power (W)	Efficiency (%)	Ta (°C)
47121	3.3	750	2.5	65	70
47122	5	550	2.75	68	70
47123	9	270	2.5	72	70
47124	12	210	2.5	74	70
47124 SLI	12	210	2.5	74	70
47125	15	170	2.5	75	70
47126	24	110	2.5	77	70
47151	3.3	1350	4.2	65	50
47157	3.8	1180	4.5	66	50
47152	5	900	4.5	68	50
47153	9	550	5	72	50
47154	12	420	5	75	50
47155	15	320	5	76	50
47156	24	220	5	79	+50

**DIMENSIONS and PINOUT**

4 PINS

PRI. Pins 1 – 5: AC Or DC Input  
 SEC. Pin 7 : DC Output +V  
 Pin 9 : DC Output 0V

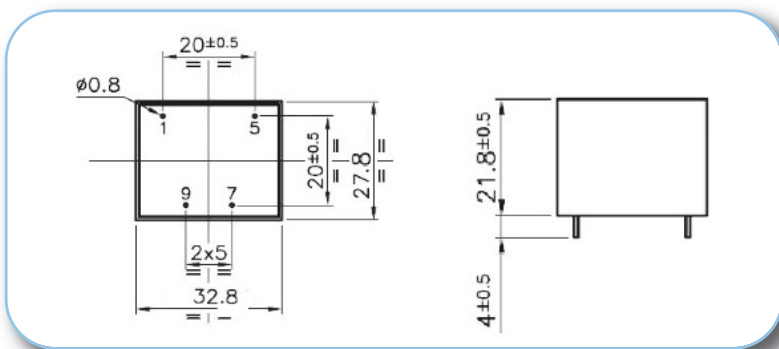

**Power Derating Curve**

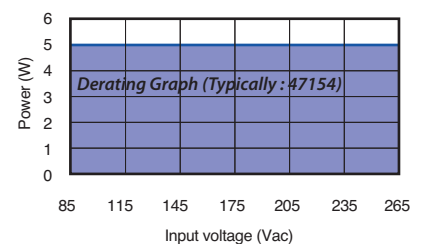

**Power Derating Curve**

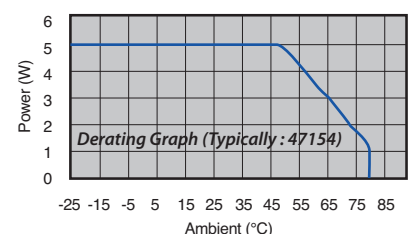



Model: 2.5 To 5 Watt		
AC Input Characteristics	Rated AC input Voltage	100~240Vac Or 140VDC-340VDC
	AC Input Voltage Range	85~265Vac Or 120VDC-370VDC
	AC Input Frequency Range	47Hz~63Hz
	Rated AC Input Frequency	50/60Hz
	Input Current	0.2A Max@85Vac~265Vac, at full load
	Standby Power	0.2W Max(Meet Requirements Of Energy Star And EC Code Of Conduct)
DC Output Characteristics	Output Voltage Accuracy	± 2%
	Output Voltage Line Regulation	± 0.5%
	Output Voltage Load Regulation	± 1%
	Ripple & Noise	Max 200mVp-p@ Rated AC input(The measuring will be terminated with a 47uF AL E-Cap and a 0.1uF Cer-Cap. An oscilloscope set at 20MHz bandwidth)
	Efficiency	See Table (Meet Requirements Of Energy Star And EC Code Of Conduct)
Protection Characteristics	Over Current Protection	The power supply shall automatic protection. The power supply shall autorecovery normal operation after the deformation is removed. No excessive heat, odor, or plastic deformation shall occur, no safety hazard
	Output Short Circuit Protection	The power supply shall withstand a continuous output short without damage in 24 hours ; The short may be applied before power on, or after power on ; The power supply shall resume normal operation after the short is removed, no excessive heat, odor, or plastic deformation shall occur, no safety hazard
Environmental	Operation Temperature	controller exceeds the thermal shutdown temperature , typically 140°C±10°C.
	Operation Humidity	10~ 90% RH(No Condensing) @ full load
	Storage Temperature	-40°C~ +85°C
	Storage Humidity	5%~95%
Safety & EMC Requirement	Dielectric Strength	Primary to Secondary: 4000Vac 5mA, 3 sec.
	Radiation	Meet EN55022,EN55014 , Class B. under 3dB margin
	Conduction	Meet EN55022,EN55014, Class B. under 3dB margin
	Safety Standards	Meet all requirements of UL/CUL60950 - IEC/EN60950 - IEC/EN60335 - EC/EN61558-2-16 CE,VDE, And ENEC Mark VDE Approval No. 40034334 - UL Approval No.E352488
Reliability Requirement	MTBF	Calculated by MIL-HDBK-217-F2 550K Hours Min. @230VAC input, 25deg.C
	Burn-In Test	The unit shall be burned in for 2~ 5hours under 230Vac input and DC with full load at an ambient temperature of 30~45 degrees C
Net Weight	About 30 grams per product unit	
Guarantee	This product meet to RoHS standard	

## MAIN FEATURES :

- 2.4 To 5W Small Compact Size - PCB Mount
- Single Output –Non Regulated
- Output Range : 5.0VDC - 24VDC
- Input Range : 85VAC - 265VAC/47 - 63Hz Or 120VDC - 370VDC
- Very Low Standby Power Consumption < 0.3W
- Better Energetic Efficiency : Meet Requirements Of Energy Star and EC Code Of Conduct
- Encapsulated Design And Same Footprint As EI30 Transformer: Upgrade Your Application Without Redesign Of PCB
- Safety : Meets All Requirements of: IEC/EN61558-2-16, IEC/EN60950, IEC/EN60335, UL/CUL60950, CE,VDE,ENEC Mark
- Materials : Uses UL 94-V0 Plastic And Resin
- EMC : Conducted And Radiated Emissions Conform To EN55014 , EN55022, CLASS B
- Immunity Conform To EN61000-3-3,EN61000-4-2, EN61000-4-3,EN61000-4-4,EN61000-4-5, EN61000-4-6, EN61000-4-8, EN61000-4-11



**CERTIFIED !**

Reference	Output voltage (DC Volts)	Output current (DC mA)	Output Power (W)	Efficiency (%)	Ta (°C)
47114	12	200	2.4	74	+70
47132	5	500	2.5	68	+70
47133	9	360	3.2	73	+70
47134	12	270	3.2	75	+70
47135	18	180	3.2	78	+70
47136	24	130	3.2	80	+70
47162	5	900	5	68	+50
47163	9	560	5	73	+50
47164	12	420	5	75	+50
47165	18	280	5	78	+50
47166	24	210	5	80	+50

## DIMENSIONS and PINOUT

4 PINS

PRI. Pins 1 – 5: AC Or DC Input

SEC. Pin 7 : DC Output +V

Pin 9 : DC Output 0V

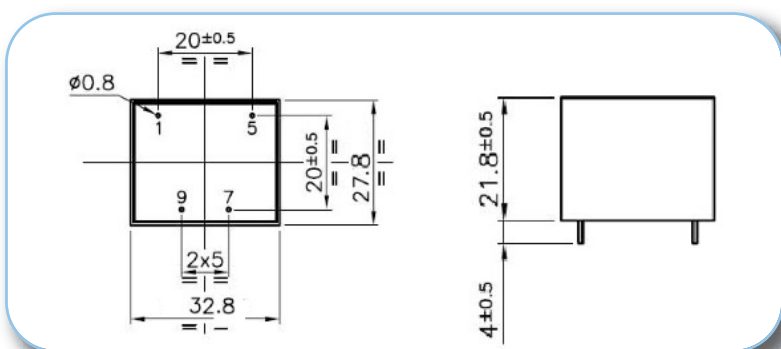

Power Derating Curve

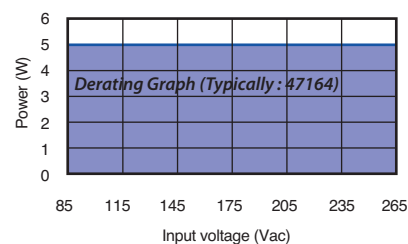

Power Derating Curve

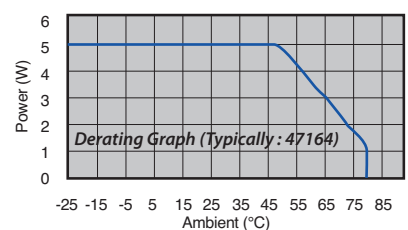



# SINGLE OUTPUT 2.4 to 5 W Non Regulated



Model: 2.5 To 5 Watt		
AC Input Characteristics	Rated AC input Voltage	100~240Vac Or 140VDC-340VDC
	AC Input Voltage Range	85~265Vac Or 120VDC-370VDC
	AC Input Frequency Range	47Hz~63Hz
	Rated AC Input Frequency	50/60Hz
	Input Current	0.2A Max@85Vac~265Vac, at full load
	Standby Power	0.2W Max(Meet Requirements Of Energy Star And EC Code Of Conduct)
DC Output Characteristics	Output Voltage Accuracy	± 2%
	Output Voltage Line Regulation	± 0.5%
	Output Voltage Load Regulation	± 1%
	Ripple & Noise	Max 200mVp-p@ Rated AC input(The measuring will be terminated with a 47uF AL E-Cap and a 0.1uF Cer-Cap. An oscilloscope set at 20MHz bandwidth)
	Efficiency	See Table (Meet Requirements Of Energy Star And EC Code Of Conduct)
Protection Characteristics	Over Current Protection	The power supply shall automatic protection. The power supply shall autorecovery normal operation after the deformation is removed. No excessive heat, odor, or plastic deformation shall occur, no safety hazard
	Output Short Circuit Protection	The power supply shall withstand a continuous output short without damage in 24 hours ; The short may be applied before power on, or after power on ; The power supply shall resume normal operation after the short is removed, no excessive heat, odor, or plastic deformation shall occur, no safety hazard
Environmental	Operation Temperature	The power supply shall shut down when the junction temperature of PWM controller exceeds the thermal shutdown temperature , typically 140°C±10°C.
	Operation Humidity	10~ 90% RH(No Condensing) @ full load
	Storage Temperature	-40°C~ +85°C
	Storage Humidity	5%~95%
Safety & EMC Requirement	Dielectric Strength	Primary to Secondary: 4000Vac 5mA, 3 sec.
	Radiation	Meet EN55022,EN55014 , Class B. under 3dB margin
	Conduction	Meet EN55022,EN55014, Class B. under 3dB margin
	Safety Standards	Meet all requirements of UL/CUL60950 - IEC/EN60950 - IEC/EN60335 - EC/EN61558-2-16 CE,VDE, And ENEC Mark VDE Approval No. 40034334 - UL Approval No.E352488
Reliability Requirement	MTBF	Calculated by MIL-HDBK-217-F2 550K Hours Min. @230VAC input, 25deg.C
	Burn-In Test	The unit shall be burned in for 2~ 5hours under 230Vac input and DC with full load at an ambient temperature of 30~45 degrees C
Net Weight	About 30 grams per product unit	
Guarantee	This product meet to RoHS standard	

## MAIN FEATURES :

- 3 To 5W Small Compact Size - PCB Mount
- Two Common Outputs - Regulated
- Output Voltage Accuracy : See Table For 15 To 100% Rated Load Of Each Output (includes line and load variations)
- Input Range : 85VAC - 265VAC/47 - 63Hz Or 120VDC - 370VDC
- Very Low Standby Power Consumption < 0.2W
- Better Energetic Efficiency : Meet Requirements Of Energy Star And EC Code Of Conduct
- Encapsulated Design And Same Footprint As EI30 Transformer: Upgrade Your Application Without Redesign Of PCB
- Safety : Meets All Requirements of: IEC/EN61558-2-16, IEC/EN60950, IEC/EN60335, UL/CUL60950, CE, VDE, ENEC Mark
- Materials : Uses UL 94-V0 Plastic And Resin
- EMC : Conducted And Radiated Emissions Conform To EN55014 , EN55022, CLASS B
- Immunity Conform To EN61000-3-3, EN61000-4-2, EN61000-4-3, EN61000-4-4, EN61000-4-5, EN61000-4-6, EN61000-4-8, EN61000-4-11



TWO COMMON OUTPUTS						
Reference	Output 1 Output 2 (DC Volts)	Output 1 Output 2 (DC mA)	Output Power (W)	Output 1 Output 2 accuracy	Efficiency (%)	Ta (°C)
47243	+10.5 +7	380 max 100 max	4.7	± 3% +15%	72	+50
47243	+10.5 +7	315 max 100 max	4	± 3% +15%	72	+60
47244	+ 15 +7	300 max 70 max	5	± 3% ± 15%	73	+50
47244	+ 15 +7	234 max 70 max	4	± 3% ± 15%	73	+60
47245	+12 +5.5	130 max 300 max	3.2	± 5% ± 10%	65	+70
47246	+5 +12	400 (600max) 170 max	4	± 3% ± 15%	65	+60
47247	+15 -15	130 max 130 max	4	± 8% ± 8%	73	+60

## DIMENSIONS and PINOUT 5 PINS

PRI: Pins 1 – 5: AC Or DC Input  
SEC: Pin 6 : DC Output 1 & 20V  
Pin 7 : DC Output 1 +V  
Pin 10 : DC Output 2 +V

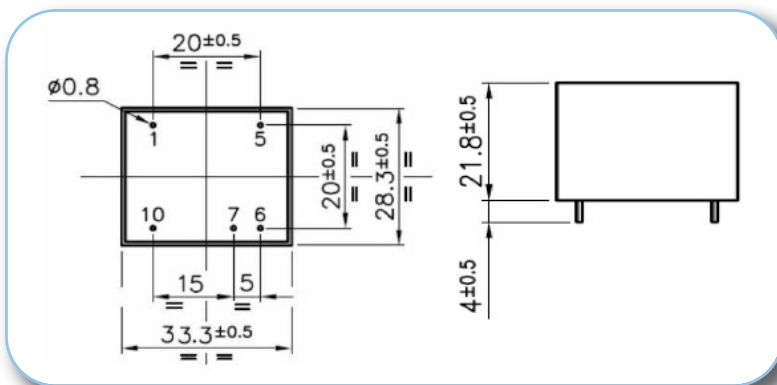

Power Derating Curve

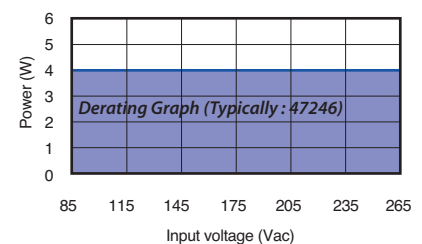

Power Derating Curve

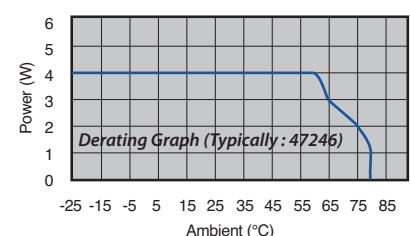



Model: Two Common Outputs 3 TO 5W		
AC Input Characteristics	Rated AC input Voltage	100~240Vac Or 140VDC-340VDC
	AC Input Voltage Range	85~265Vac Or 120VDC-370VDC
	AC Input Frequency Range	47Hz~63Hz
	Rated AC Input Frequency	50/60Hz
	Input Current	0.2A Max@85Vac~265Vac, at full load
	Standby Power	0.2W Max (Meet Requirements Of Energy Star And EC Code Of Conduct)
DC Output Characteristics	Output Voltage Accuracy	See Table For 15 To 100% Rated Load Of Each Output (includes line and load variations)
	Efficiency	See Table(Meet Requirements Of Energy Star And EC Code Of Conduct)
Protection Characteristics	Over Current Protection	The power supply shall automatic protection. The power supply shall autorecovery normal operation after the deformation is removed. No excessive heat, odor, or plastic deformation shall occur, no safety hazard
	Output Short Circuit Protection	The power supply shall withstand a continuous output short without damage in 24 hours; The short may be applied before power on, or after power on ; The power supply shall resume normal operation after the short is removed, no excessive heat, odor, or plastic deformation shall occur, no safety hazard
	Over Temperature Protection	The power supply shall shut down when the junction temperature of PWM controller exceeds the thermal shutdown temperature, typically 140°C±10°C.
Environmental	Operation Temperature	-25°C ~ +Ta (see table)
	Operation Humidity	10~ 90% RH(No Condensing) @ full load
	Storage Temperature	-40°C~ +85°C
	Storage Humidity	5%~95%
Safety & EMC Requirement	Dielectric Strength	Primary to Secondary: 4000Vac 5mA, 3 sec.
	Radiation	Meet EN55022,EN55014, Class B. under 3dB margin
	Conduction	Meet EN55022,EN55014,Class B. under 3dB margin
	Safety Standards	Meets all requirements of UL/CUL60950 IEC/EN60950 IEC/EN60335 IEC/EN61558-2-16 CE,VDE, And ENEC Mark VDE Approval No. 40034334 UL Approval No.E352488
Reliability Requirement	MTBF	Calculated by MIL-HDBK-217-F2 550K Hours Min. @230VAC input, 25deg.C
	Burn-In Test	The unit shall be burned in for 2~ 5hours under 230Vac input and DC with full load at an ambient temperature of 30~45 degrees C
Net Weight	About 30 grams per product unit	
Guarantee	This product meet to RoHS standard	

**MAIN FEATURES :**

- 3 To 5W Small Compact Size - PCB Mount
- Two Isolated Outputs - Regulated
- Output Voltage Accuracy : See Table For 15 To 100% Rated Load Of Each Output (includes line and load variations)
- Input Range : 85VAC - 265VAC/47 - 63Hz Or 120VDC - 370VDC
- Very Low Standby Power Consumption < 0.2W
- Better Energetic Efficiency : Meet Requirements Of Energy Star And EC Code Of Conduct
- Encapsulated Design And Same Footprint As EI30 Transformer: Upgrade Your Application Without Redesign Of PCB
- Safety : Meets All Requirements of: IEC/EN61558-2-16, IEC/EN60950,IEC/EN60335, UL/CUL60950, CE,VDE,ENEC Mark
- Materials : Uses UL 94-V0 Plastic And Resin
- EMC : Conducted And Radiated Emissions Conform To EN55014 , EN55022, CLASS B
- Immunity Conform To EN61000-3-3,EN61000-4-2,EN61000-4-3,EN61000-4-4,EN61000-4-5, EN61000-4-6, EN61000-4-8, EN61000-4-11



ISOLATED OUTPUT						
Reference	Output 1 Output 2 (DC Volts)	Output 1 Output 2 (DC mA)	Output Power (W)	Output 1 Output 2 accuracy	Efficiency (%)	Ta (°C)
47252	5 5	350 (600max) 350 max	3.5	± 3% +15%	66	+60
47254	12 12	165 (300max) 165 max	4	± 5% ± 15%	72	+60
47255	15 15	135 (200max) 135 max	4	± 5% ± 15%	73	+60
47257	5 12	400 (600max) 170 max	4	± 3% ± 15%	68	+60
47258	18 8	150 (200max) 150 max	4	± 5% ± 15%	72	+60

**DIMENSIONS and PINOUT 6 PINS**

- pins 1 & 5 : AC or DC Input
- pin 6: DC output1 0V
- pin 7: DC output1 +V
- pin 9: DC output2 0V
- pin 10: DC output2 +V

**ISOLATED OUTPUT**

Input / Output Isolation test voltage: 4000 Vac  
Output1 / Output 2 isolation : 4000Vac

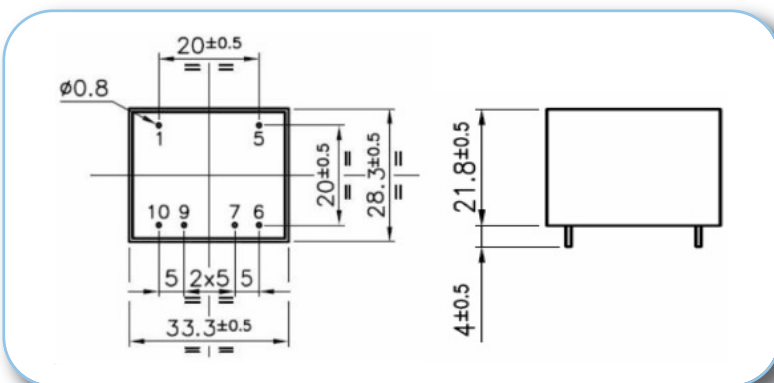

Power Derating Curve

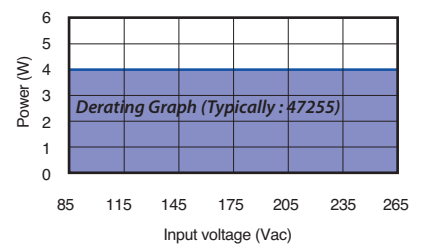

Power Derating Curve

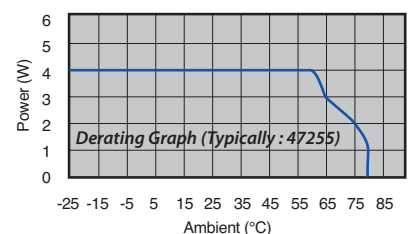

# TWO OUTPUTS ISOLATED 3 to 5 W Regulated



Model: Two Isolated Outputs 3 to 5W		
AC Input Characteristics	Rated input Voltage	100~240Vac Or 140VDC-340VDC
	Input Voltage Range	85~265Vac Or 120VDC-370VDC
	AC Input Frequency Range	47Hz~63Hz
	Rated AC Input Frequency	50/60Hz
	Input Current	0.2A Max@85Vac~265Vac, at full load
	Standby Power	0.2W Max(Meet Requirements Of Energy Star And EC Code Of Conduct)
DC Output Characteristics	Output Voltage Accuracy	See Table For 15 To 100% Rated Load Of Each Output (includes line and load variations)
	Turn On Delay	2S max @ 85Vac~265Vac input and DC output with full load
	Efficiency	See Table (Meet Requirements Of Energy Star And EC Code Of Conduct)
Protection Characteristics	Over Current Protection	The power supply shall automatic protection. The power supply shall auto-recovery normal operation after the deformation is removed. No excessive heat, odor, or plastic deformation shall occur, no safety hazard
	Output Short Circuit Protection	The power supply shall withstand a continuous output short without damage in 24 hours ; The short may be applied before power on, or after power on; The power supply shall resume normal operation after the short is removed, no excessive heat, odor, or plastic deformation shall occur, no safety hazard
	Over Temperature Protection	the thermal shutdown temperature, typically 140°C±10°C.
Environmental	Operation Temperature	-25°C ~ +Ta (see table)
	Operation Humidity	10~ 90% RH(No Condensing) @ full load
	Storage Temperature	-40°C~ +85°C
	Storage Humidity	5%~95%
Safety & EMC Requirement	Dielectric Strength	Primary to Secondary: 4000Vac 5mA, 3 sec. Output1 to output2: 4000Vac 5mA, 3 sec
	Radiation	Meet EN55022,EN55014, Class B. under 3dB margin
	Conduction	Meet EN55022,EN55014,Class B. under 3dB margin
	Power Clamp Radiation	EN55014-1:2006+A1:2009+A2:2011
	Lightning Surge	EN61000-4-5:2006, Level II. 1KV
	Electric Fast Transient	Meeting EN61000-4-4:2012, 1KV
	Safety Standards	Meets all requirements of UL/CUL6095 , IEC/EN60950 , IEC/EN60335, EC/EN61558-2-16 , CE,VDE,And ENEC Mark VDE Approval No. 40034334 , UL Approval No.E352488
Reliability Requirement	MTBF	Calculated by MIL-HDBK-217-F2 550K Hours Min. @230VAC input, 25deg.C
	Burn-In Test	The unit shall be burned in for 2~ 5hours under 230Vac input and DC with full load at an ambient temperature of 30~45 degrees C
Net Weight	About 30 grams per product unit	
Guarantee	This product meet to RoHS standard	

# SINGLE OUTPUT 7.5 W Regulated



## MAIN FEATURES :

- 7.5W Small Compact Size - PCB Mount
- Single Output - Regulated
- Output Range : 3.3VDC - 24VDC
- Input Range : 85VAC - 265VAC/47 - 63Hz Or 120VDC - 370VDC
- Very Low Standby Power Consumption < 0.15W
- Better Energetic Efficiency : Meet Requirements Of Energy Star And EC Code Of Conduct
- Encapsulated Design And Same Footprint As EI38 Transformer: Upgrade Your Application Without Redesign Of PCB
- Safety : IEC/EN61558-2-16,IEC/EN60950,IEC/EN60335, UL/CUL60950,CE,VDE,ENEC Mark
- Materials : Uses UL 94-V0 Plastic And Resin
- EMC : Conducted And Radiated Emissions Conform To EN55014 CLASS B , EN55022 CLASS B And FCC Part 15
- Immunity Conform To EN61000-3-3,EN61000-4-2, EN61000-4-3,EN61000-4-4,EN61000-4-5, EN61000-4-6, EN61000-4-8, EN61000-4-11



7.5W Regulated							
Reference	Output (DC Volts)	Output (DC mA)	Output voltage accuracy	Output Power (max W)	Load output voltage regulation	Efficiency (%) @230VAC	Ta (°C)
47206	3.3	2270	± 3%	7.5	± 3%	>74	+70
47200	5	1500	± 2%	7.5	± 1%	>76	+70
47201	9	830	± 2%	7.5	± 1%	>80	+70
47202	12	625	± 2%	7.5	± 1%	>82	+70
47203	15	500	± 2%	7.5	± 1%	>82	+70
47204	18	420	± 2%	7.5	± 1%	>82	+70
47205	24	310	± 2%	7.5	± 1%	>82	+70

## DIMENSIONS and PINOUT 4 PINS

PRI: Pins 1 – 5: AC Or DC Input

SEC: Pin 7 : DC Output +V

Pin 9 : DC Output 0V

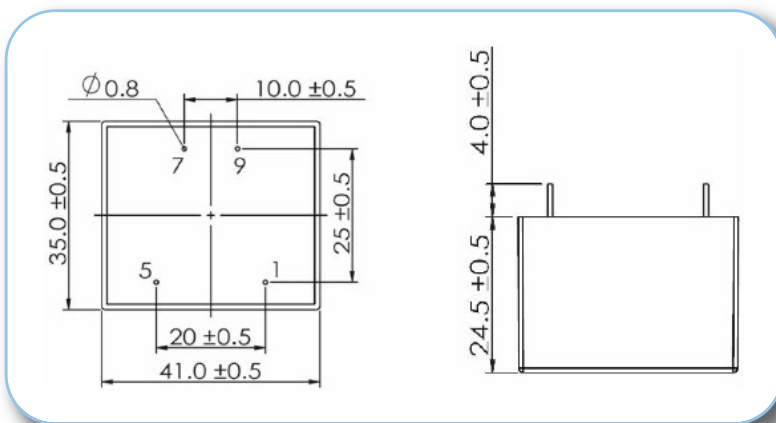

Power Derating Curve

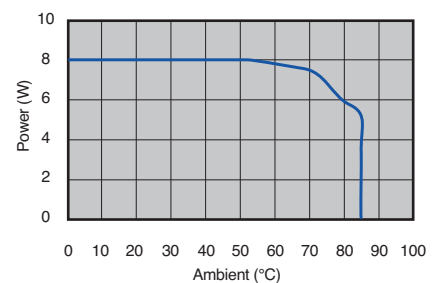

Power Derating Curve

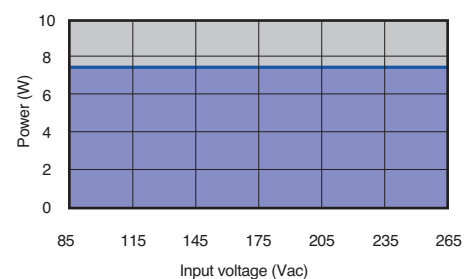

# SINGLE OUTPUT 7.5 W Regulated



Model: 7.5 Watt		
AC Input Characteristics	Rated AC input Voltage	100~240Vac Or 140VDC-340VDC
	AC Input Voltage Range	85~265Vac Or 120VDC-370VDC
	AC Input Frequency Range	47Hz~63Hz
	Rated AC Input Frequency	50/60Hz
	Input Current	0.3A Max@85Vac~265Vac, at full load
	Standby Power	0.15W Max(Meet Requirements Of Energy Star And EC Code Of Conduct)
DC Output Characteristics	Output Voltage Accuracy	± 2% (5V,9V,12V,15V,18V,24V Types) - ± 3%(3.3V Type)
	Output Voltage Line Regulation	± 0.5%
	Output Voltage Load Regulation	± 1%(5V,9V,12V,15V,18V,24V Types) ± 3%(3.3V Type)
	Ripple & Noise	Max 180mVp-p@ Rated AC input, at nominal line (The measuring will be terminated with a 47uF AL E-Cap and a 0.1uF Cer-Cap. An oscilloscope set at 20MHz bandwidth)
	Efficiency	Meet Requirements Of Energy Star And EC Code Of Conduct
Protection Characteristics	Over Current Protection	The power supply shall automatic protection. The power supply shall autorecovery normal operation after the deformation is removed. No excessive heat, odor, or plastic deformation shall occur, no safety hazard
	Output Short Circuit Protection	The power supply shall withstand a continuous output short without damage in 24 hours; The short may be applied before power on, or after power on; The power supply shall resume normal operation after the short is removed, no excessive heat, odor, or plastic deformation shall occur, no safety hazard
Environmental	Operation Temperature	-20°C ~ +Ta (see table)
	Operation Humidity	10~ 90% RH(No Condensing) @ full load
	Storage Temperature	-40°C~ +85°C
	Storage Humidity	5%~95%
Safety & EMC Requirement	Dielectric Strength	Primary to Secondary: 4000Vac 5mA, 3 sec.
	Radiation	Meet EN55022,EN55014,FCC, part 15, Class B. under 3dB margin
	Conduction	Meet EN55022,EN55014, FCC, part 15,Class B. under 3dB margin
	Safety Standards	Meet all requirements of UL/CUL60950 IEC/EN60950 IEC/EN60335 IEC/EN61558-2-16 CE,VDE and ENEC Mark
Reliability Requirement	MTBF	Calculated by MIL-HDBK-217-F2 550K Hours Min. @230VAC input, 25deg.C
	Burn-In Test	The unit shall be burned in for 2~ 5hours under 230Vac input and DC with full load at an ambient temperature of 30~45 degrees C
Net Weight	About 56 grams per product unit	
Guarantee	This product meet to RoHS standard	

# SINGLE OUTPUT 10 W Regulated



## MAIN FEATURES :

- 10W Small Compact Size - PCB Mount
- Single Output - Regulated
- Output Range : 3.3VDC - 24VDC
- Input Range : 85VAC - 265VAC/47 - 63Hz Or 120VDC - 370VDC
- Very Low Standby Power Consumption < 0.1W
- Better Energetic Efficiency : Meet Requirements Of Energy Star And EC Code Of Conduct
- Encapsulated Design And Same Footprint As EI48 Transformer: Upgrade Your Application Without Redesign Of PCB
- Safety : IEC/EN61558-2-16, IEC/EN60950, IEC/EN60335, UL/CUL60950, CE, VDE, ENEC Mark
- Materials : Uses UL 94-V0 Plastic And Resin
- EMC : Conducted And Radiated Emissions Conform To EN55014 CLASS B , EN55022 CLASS B And FCC Part 15
- Immunity Conform To EN61000-3-3, EN61000-4-2, EN61000-4-3, EN61000-4-4, EN61000-4-5, EN61000-4-6, EN61000-4-8, EN61000-4-11

10W Regulated						
Part No	Power Rating Watts	Output Voltage (VDC)	Output Current (mA)	Ambient Temp. (°C)	Efficiency Typical	Input Range
47210	10	5	2000	60	>74%@230VAC	85VAC-265VAC (120VDC-370VDC)
47211	10	9	1100	60	>80%@230VAC	
47212	10	12	830	60	>82%@230VAC	
47213	10	15	670	60		
47214	10	18	560	60		
47215	10	24	420	60		
47216	10	3.3	3000	50	>72%@230VAC	

## DIMENSIONS and PINOUT 4 PINS

PRI: Pins 1 – 5: AC Or DC Input  
SEC: Pin 7 : DC Output +V  
Pin 9 : DC Output 0V

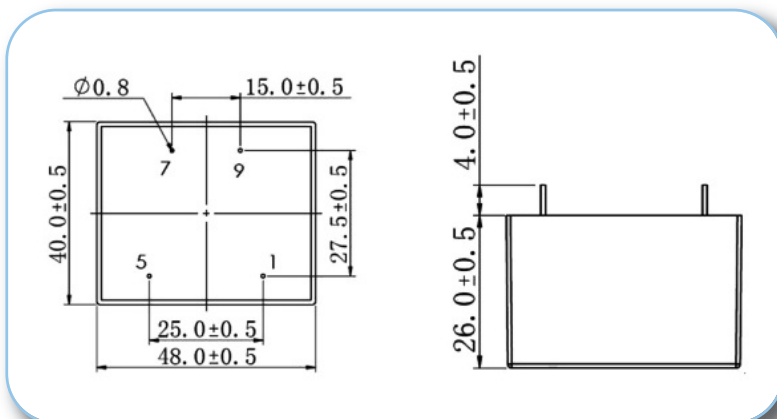

Power Derating Curve

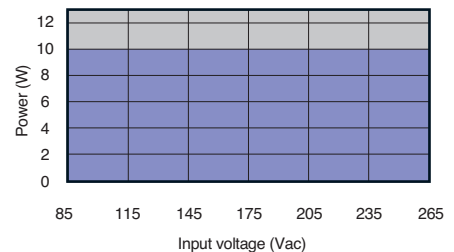

Power Derating Curve

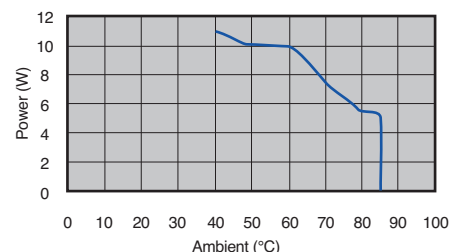



# SINGLE OUTPUT 10 W Regulated



Model: 10 Watt		
AC Input Characteristics	Rated AC input Voltage	100~240Vac Or 140VDC-340VDC
	AC Input Voltage Range	85~265Vac Or 120VDC-370VDC
	AC Input Frequency Range	47Hz~63Hz
	Rated AC Input Frequency	50/60Hz
	Input Current	0.4A Max@85Vac~265Vac, at full load
	Input Inrush Current	40A Max @85Vac~265Vac input, cold start, full load
	Standby Power	0.1W Max(Meet Requirements Of Energy Star And EC Code Of Conduct)
DC Output Characteristics	Output Voltage Accuracy	± 2% (9V,12V,15V,18V,24V Types) ± 3% (5V Type) ± 4%(3.3V Type)
	Output Voltage Line Regulation	± 0.5%(9V,12V,15V,18V,24V Types) ± 1%(3.3V and 5V Types )
	Output Voltage Load Regulation	± 1%(9V,12V,15V,18V,24V Types) ± 3% (5V Type) ± 4%(3.3V Type)
	Ripple & Noise	Max 150mVp-p @Rated AC input (The measuring will be terminated with a 47uF AL E-Cap and a 0.1uF Cer-Cap. An oscilloscope set at 20MHz bandwidth)
	Dynamic Response	The output voltage shall not exceed ±10% rated output voltage @ 10%↔90% Load change, 1A/uS , 1KHz 50% duty cycle
	Overshoot	The output voltage shall not exceed +10% rated output voltage @ Power on and 85Vac~265Vac input, and DC with full load
	Undershoot	The output voltage shall not exceed -10% rated output voltage @ Power off and 85Vac~265Vac input and DC output with full load
	Hold Up Time	5mS Min@ 100Vac ~240Vac, DC output with full load
	Turn On Delay	3S max @ 85Vac~265Vac input and DC output with full load
	Rise Time	50ms Max @ 85Vac~265Vac input and DC output with full load
Efficiency	See table (Meet Requirements Of Energy Star And EC Code Of Conduct)	
Protection Characteristics	Over Current Protection	The power supply shall automatic protection. The power supply shall autorecovery normal operation after the deformation is removed. No excessive heat, odor, or plastic deformation shall occur, no safety hazard
	Output Short Circuit Protection	The power supply shall withstand a continuous output short without damage in 24 hours; The short may be applied before power on, or after power on ; The power supply shall resume normal operation after the short is removed, no excessive heat, odor, or plastic deformation shall occur, no safety hazard
	Over temperature protection	The power supply shall shut down when the junction temperature of PWM controller exceeds the thermal shutdown temperature typically 140°C ±10°C.

# SINGLE OUTPUT 10 W Regulated



Model: 10 Watt		
Environmental	Operation Temperature	-25°C ~ +Ta (see table)
	Operation Humidity	10~ 90% RH(No Condensing) @ full load
	Storage Temperature	-40°C~ +85°C
	Storage Humidity	5%~95%
	Cooling Method	Ordinary or thermostat
Safety & EMC Requirement	Dielectric Strength	Primary to Secondary: 4000Vac 5mA, 3 sec.
	Radiation	Meeting EN55022,EN55014,FCC, part 15, Class B. under 3dB margin
	Conduction	Meeting EN55022,EN55014, FCC, part 15,Class B. under 3dB margin
	Power Clamp Radiation	Meeting EN 55014-1: 2006+A1: 2009+A2:2011
	Lightning Surge	Meeting EN61000-4-5:2006, Level II. ±2KV
	Electric Fast Transient	Meeting EN61000-4-4:2012, ±4KV
	Voltage Dips And Interruptions	Meeting EN61000-4-11:2004
	Voltage Fluctuation And Flicker	Meeting EN61000-3-3:2013
	Electrostatic Discharge	Meeting EN61000-4-2:2009 Contact Discharge ±4KV,Air Discharge ±8KV
	RF Field Strength Susceptibility	Meeting EN61000-4-3:2006+A1:2008+A2:2010
	Conducted Susceptibility	Meeting EN61000-4-6:2014
	Power Frequency Magnetic Field Susceptibility	Meeting EN61000-4-8:2010
Safety Standards	Meet all requirements of UL/CUL60950 IEC/EN60950 IEC/EN60335 IEC/EN61558-2-16 CE,VDE And ENEC Mark	
Reliability Requirement	MTBF	Calculated by MIL-HDBK-217-F2 5V ,9V,12V,15V,18V,24V Types: 200K Hours Min. @230VAC input, 60deg.C 3.3V type: 200K Hours Min. @230VAC input, 50deg.C
	Burn-In Test	The unit shall be burned in for 2~ 5hours under 230Vac input and DC with full load at an ambient temperature of 30~45 degrees C
Mechanical	Physical Size	The units do not including PINs of input and output, and dimension is (L)48.0*(W)40.0*(H)26.0± 0.5mm (see appearance drawing)
	Net Weight	About 80.2 grams per product unit.
Guarantee	This product meet to RoHS standard	

# MYYRA SMPS APPLICATION NOTES

## 1 – Storage Guide:

Storage temperature:  $-40^{\circ}\text{C}$  to  $+85^{\circ}\text{C}$ , Storage humidity: 5% to 95%

## 2 – Shelf life Guide:

To ensure best power supply reliability and life, we would recommend clients to keep the shelf life less than 6 months. If the power supply is not used or is kept in stock more than 12 months, it is recommended that the power supply should be subject to a 2 hour burn in process.

## 3- Safety and recommend wiring: linewidth $A \geq 2\text{mm}$ , $B \geq 5\text{mm}$ .

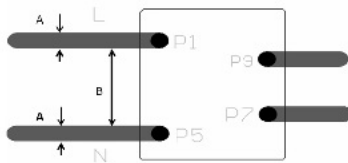

## 4- Recommended circuit for applications requiring higher EMC performance:

The 47 /48 series are already certified as compliant to EN55022 and EN55014 CLASS B for emc. For this compliance no additional external components are required. Should a more stringent emc performance be required the circuit below can be proposed

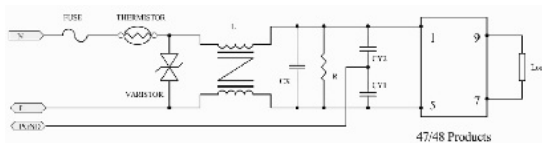

## 5 – Application of the connection to ground:

This application is not supported for 47 /48 products

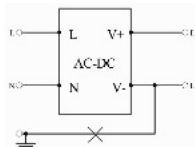

The following proposed circuit may assist:

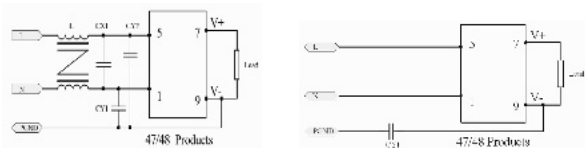

L is a common mode inductor, the recommended parameters: 10mH to 30mH

CX1 is an X2 capacitor, the recommended parameters: 0.1uF to 0.22uF/275Vac

CY1 and CY2 are Y capacitors, the recommended parameters: 1000pF to 2200pF/400V

## 6 – High surge circuit:

The 47 /48 Series is tested and certified for a surge level in accordance with IEC61000-4-5 as standard without requiring any additional external components. To extend the surge level to 6KV the external circuit below can be proposed.

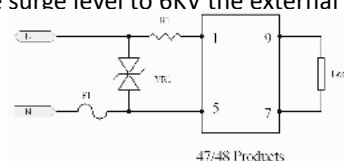

VR1 is a varistor, the recommended parameters: 14D471,300Vac, maximum energy 118 Joule.

R1 is a wire-wound resistor, the recommended parameters: 10R/1W to 10R/3W, resistance wire  $\Phi 0.1$  to 0.23mm.

F1 is a fuse, the recommended parameters: 6.3A to 10A/250Vac, Time-lag type.

The information contained in this document is subject to change without notice.

**47000 SERIES  
48000 SERIES**



[myrra.com](http://myrra.com)