



**SEMIPACK® 5**

## Thyristor Modules

### SKKT 570/16 E

#### Features

- Heat transfer through aluminium nitride ceramic isolated metal baseplate
- Precious metal pressure contacts for high reliability
- Thyristor with amplifying gate
- UL recognized, file no. E 63 532

#### Typical Applications\*

- AC motor softstarters
- Input converters for AC inverter drives
- DC motor control (e.g. for machine tools)
- Temperature control (e.g. for ovens, chemical, processes)
- Professionals light dimming (studios, theaters)

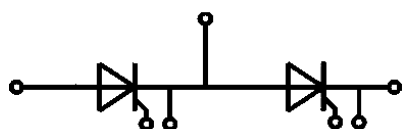

**SKKT**

Absolute Maximum Ratings				
Symbol	Conditions		Values	Unit
<b>Chip</b>				
$I_{T(AV)}$	sinus 180°	$T_c = 85\text{ °C}$	570	A
		$T_c = 100\text{ °C}$	435	A
$I_{TRMS}$	continuous operation		1000	A
$I_{TSM}$	10 ms	$T_j = 25\text{ °C}$	19000	A
		$T_j = 135\text{ °C}$	15500	A
$i^2t$	10 ms	$T_j = 25\text{ °C}$	1805000	A <sup>2</sup> s
		$T_j = 135\text{ °C}$	1201250	A <sup>2</sup> s
$V_{RSM}$			1700	V
$V_{RRM}$			1600	V
$V_{DRM}$			1600	V
$(di/dt)_{cr}$	$T_j = 135\text{ °C}$		250	A/μs
$(dv/dt)_{cr}$	$T_j = 135\text{ °C}$		1000	V/μs
$T_j$			-40 ... 135	°C
<b>Module</b>				
$T_{stg}$			-40 ... 125	°C
$V_{isol}$	a.c.; 50 Hz; r.m.s.	1 min	3000	V
		1 s	3600	V

Characteristics						
Symbol	Conditions		min.	typ.	max.	Unit
<b>Chip</b>						
$V_T$	$T_j = 25\text{ °C}, I_T = 1700\text{ A}$				1.44	V
$V_{T(TO)}$	$T_j = 135\text{ °C}$				0.78	V
$r_T$	$T_j = 135\text{ °C}$				0.32	mΩ
$I_{DD}; I_{RD}$	$T_j = 135\text{ °C}, V_{DD} = V_{DRM}; V_{RD} = V_{RRM}$				225	mA
$t_{gd}$	$T_j = 25\text{ °C}, I_G = 1\text{ A}, di_G/dt = 1\text{ A}/\mu\text{s}$			1		μs
$t_{gr}$	$V_D = 0.67 * V_{DRM}$			2		μs
$t_q$	$T_j = 135\text{ °C}$			200		μs
$I_H$	$T_j = 25\text{ °C}$			150	500	mA
$I_L$	$T_j = 25\text{ °C}, R_G = 33\text{ }\Omega$			300	2000	mA
$V_{GT}$	$T_j = 25\text{ °C}, \text{d.c.}$		3			V
$I_{GT}$	$T_j = 25\text{ °C}, \text{d.c.}$		200			mA
$V_{GD}$	$T_j = 135\text{ °C}, \text{d.c.}$				0.25	V
$I_{GD}$	$T_j = 135\text{ °C}, \text{d.c.}$				10	mA
$R_{th(j-c)}$	continuous DC	per chip			0.069	K/W
		per module			0.034	K/W
$R_{th(j-c)}$	sin. 180°	per chip			0.072	K/W
		per module			0.036	K/W
$R_{th(j-c)}$	rec. 120°	per chip			0.077	K/W
		per module			0.038	K/W
<b>Module</b>						
$R_{th(c-s)}$	chip				0.02	K/W
	module				0.01	K/W
$M_s$	to heatsink M6		4.25		5.75	Nm
$M_t$	to heatsink M10		10.2		13.8	Nm
a					5 * 9,81	m/s <sup>2</sup>
w				1400		g

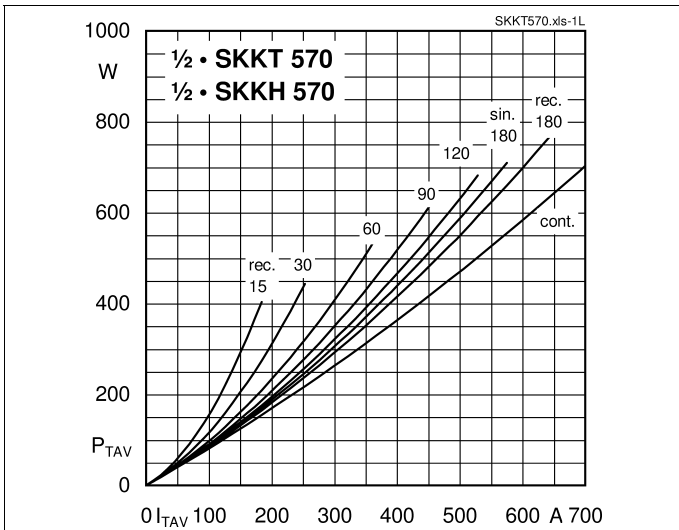

Fig. 1L: Power dissipation per thyristor vs. on-state current

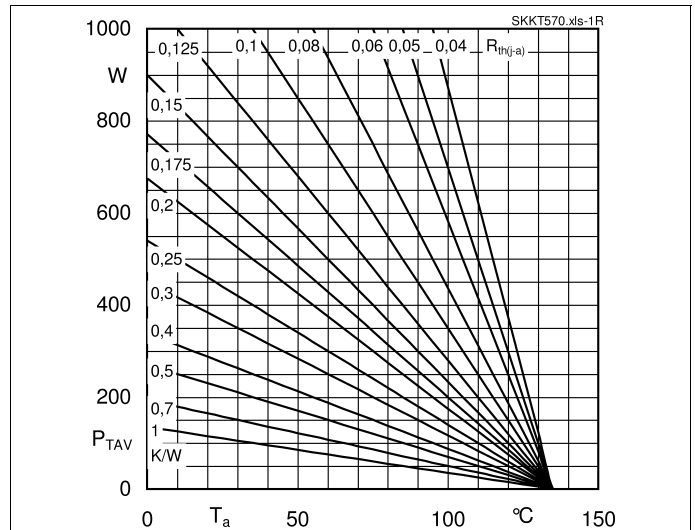

Fig. 1R: Power dissipation per thyristor vs. ambient temperature

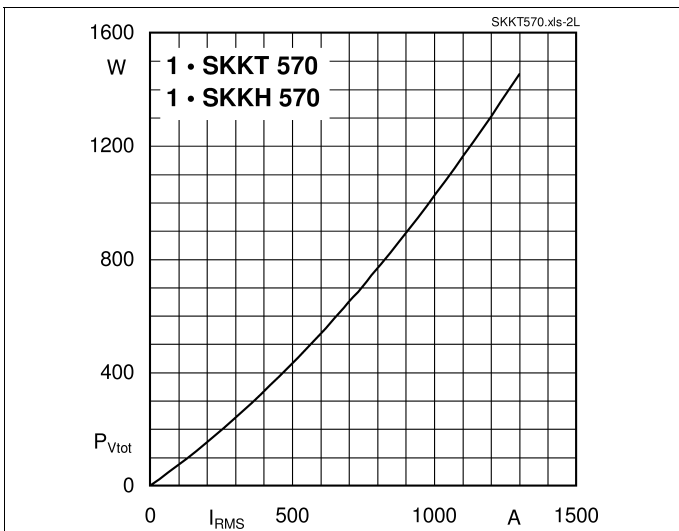

Fig. 2L: Power dissipation of one module vs. rms current

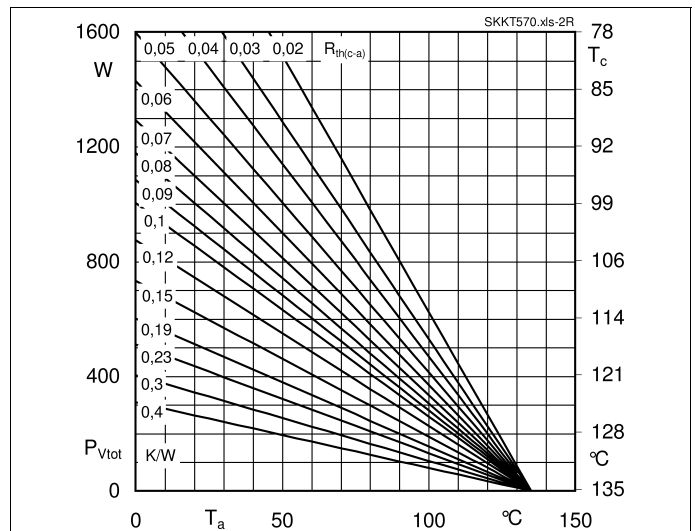

Fig. 2R: Max. power dissipation of one module vs. case temperature

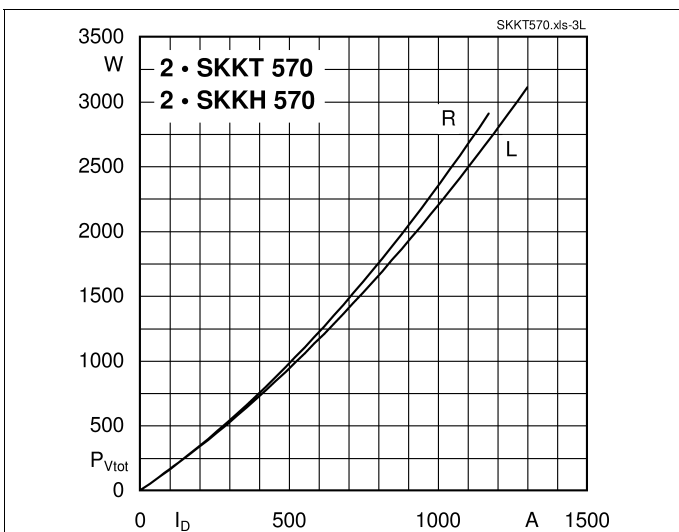

Fig. 3L: Power dissipation of two modules vs. direct current

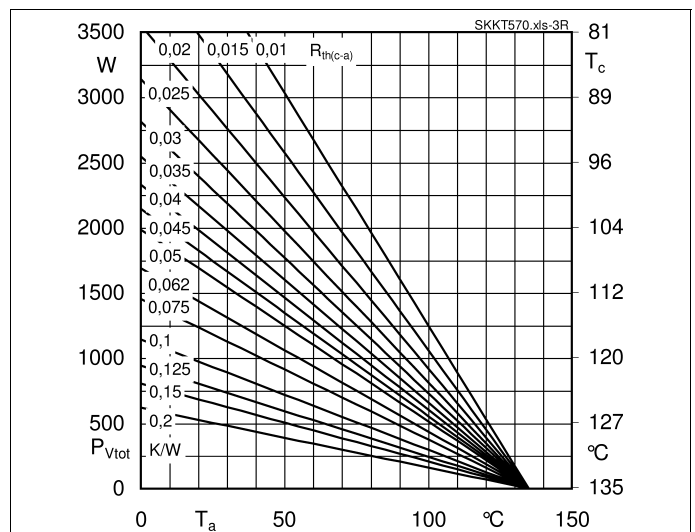

Fig. 3R: Power dissipation of two modules vs. case temperature

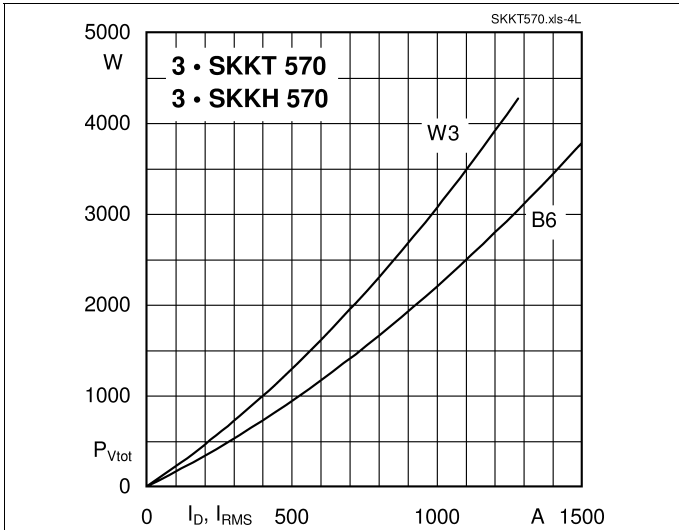

Fig. 4L: Power dissipation of three modules vs. direct and rms current

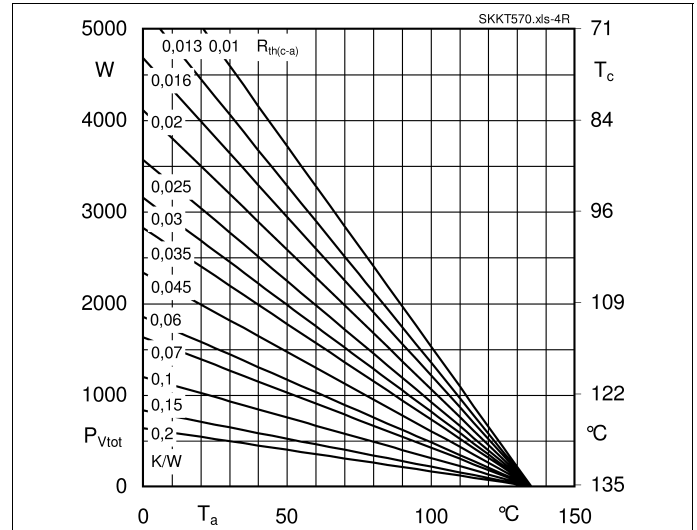

Fig. 4R: Power dissipation of three modules vs. case temperature

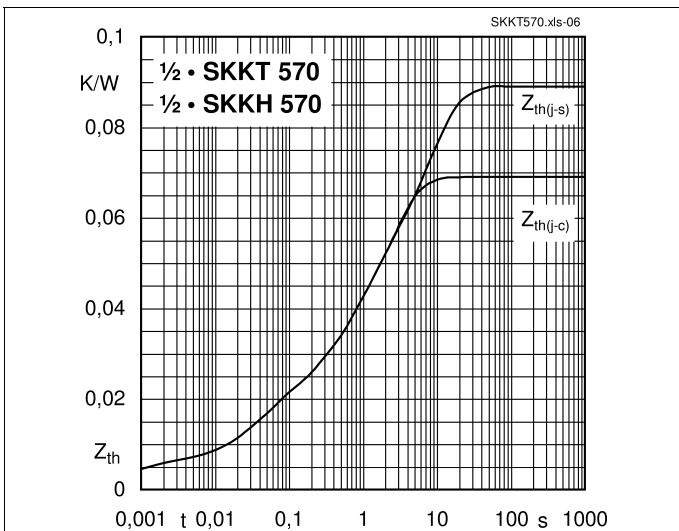

Fig. 6: Transient thermal impedance vs. time

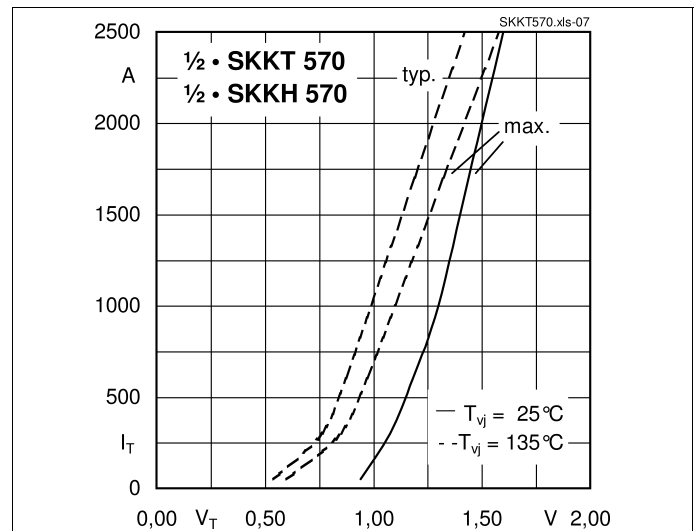

Fig. 7: On-state characteristics

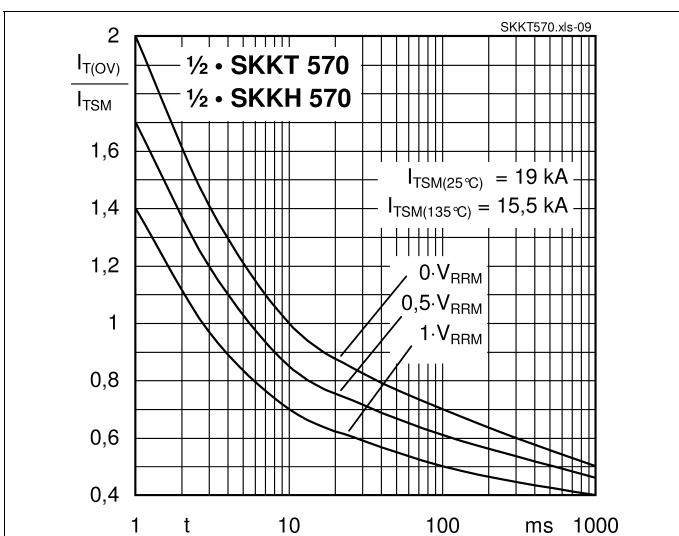

Fig. 8: Surge overload current vs. time

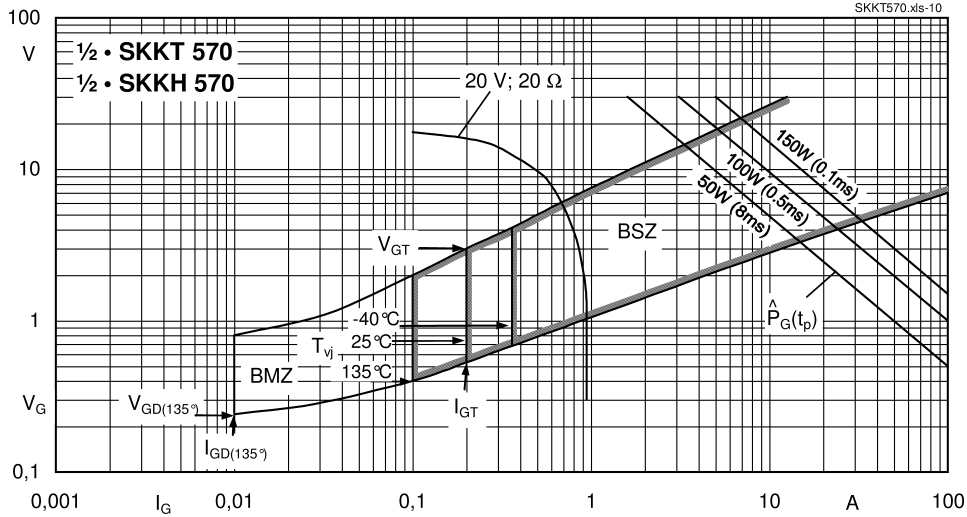
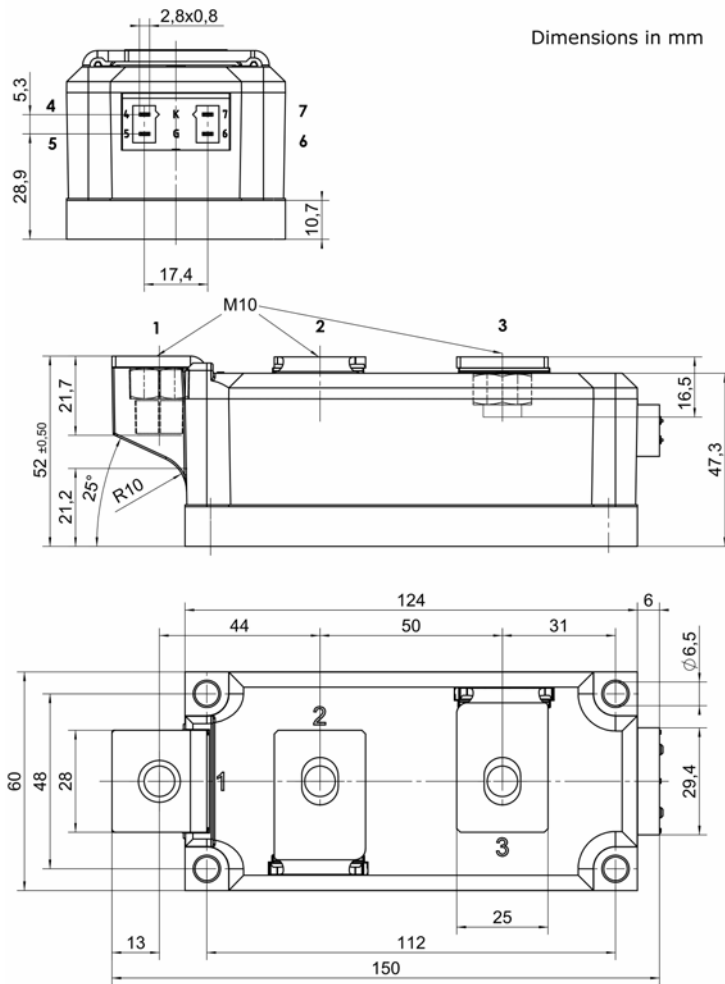
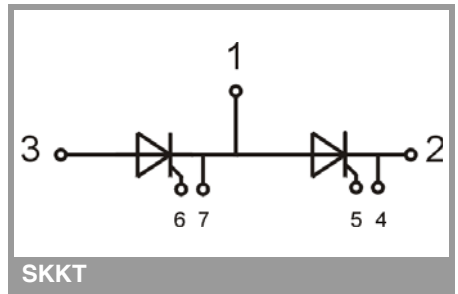

Fig. 9: Gate trigger characteristics



General tolerance  $\pm 0.5$  mm

SEMPACK 5



SKKT

This is an electrostatic discharge sensitive device (ESDS), international standard IEC 60747-1, Chapter IX

\* The specifications of our components may not be considered as an assurance of component characteristics. Components have to be tested for the respective application. Adjustments may be necessary. The use of SEMIKRON products in life support appliances and systems is subject to prior specification and written approval by SEMIKRON. We therefore strongly recommend prior consultation of our staff.