

Features

- ✧ For surface mounted application
- ✧ Low-Profile Package
- ✧ Ideal for automated pick & place
- ✧ Low power loss, high efficiency
- ✧ High current capability, low VF
- ✧ High surge current capability
- ✧ Meet MSL level 1, per J-STD-020D, lead free maximum peak of 260°C
- ✧ Plastic material used carriers Underwriters Laboratory Classification 94V-0
- ✧ Epitaxial construction
- ✧ High temperature soldering guaranteed: 260°C/10s at terminals
- ✧ Green compound with suffix "G" on packing code & prefix "G" on datecode

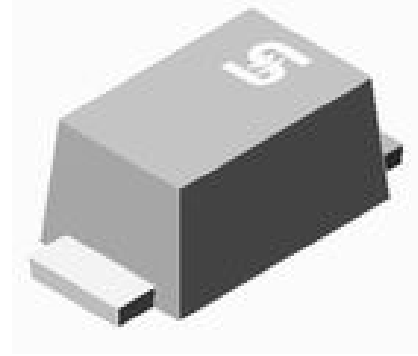

Mechanical Data

- ✧ Case: Sub SMA plastic case
- ✧ Terminal: Pure tin plated, lead free
- ✧ Polarity: Color band denotes cathode end
- ✧ Packaging: 12mm tape per EIA Std RS-481
- ✧ Weight: 19.6 mg

Ordering Information (example)

Part No.	Package	Packing	Packing code	Green Compound Packing code
SS12L	Sub-SMA	3K / 7" REEL	RV	RVG

Maximum Ratings and Electrical Characteristics

Rating at 25 °C ambient temperature unless otherwise specified.

Single phase, half wave, 60 Hz, resistive or inductive load.

For capacitive load, derate current by 20%

Type Number	Symbol	SS 12L	SS 13L	SS 14L	SS 15L	SS 16L	SS 19L	SS 110L	SS 115L	Unit
Maximum Repetitive Peak Reverse Voltage	V_{RRM}	20	30	40	50	60	90	100	150	V
Maximum RMS Voltage	V_{RMS}	14	21	28	35	42	63	70	105	V
Maximum DC Blocking Voltage	V_{DC}	20	30	40	50	60	90	100	150	V
Marking Code		12LYM	13LYM	14LYM	15LYM	16LYM	19LYM	10LYM	A5LYM	
Maximum Average Forward Rectified Current	$I_{F(AV)}$	1								A
Peak Forward Surge Current, 8.3 ms Single Half Sine-wave Superimposed on Rated Load	I_{FSM}	30								A
Maximum Instantaneous Forward Voltage (Note 1) @ 0.5A @ 1.0A	V_F	0.385 0.45	0.43 0.50	0.51 0.55	0.58 0.70		0.70 0.80		0.75 0.90	V
Maximum Reverse Current @ Rated VR $T_A=25\text{ }^\circ\text{C}$ $T_A=100\text{ }^\circ\text{C}$ $T_A=125\text{ }^\circ\text{C}$	I_R	0.4						0.05		mA
		8.0	6.0				-			
		-						0.5		
Typical Thermal Resistance	$R_{\theta JA}$	100								$^\circ\text{C/W}$
	$R_{\theta JL}$	45								
Operating Temperature Range	T_J	- 55 to + 150								$^\circ\text{C}$
Storage Temperature Range	T_{STG}	- 55 to + 150								$^\circ\text{C}$

Note 1: Pulse Test with PW=300u sec, 1% Duty Cycle

RATINGS AND CHARACTERISTIC CURVES (SS12L THRU SS115L)

FIG.1 FORWARD CURRENT DERATING CURVE

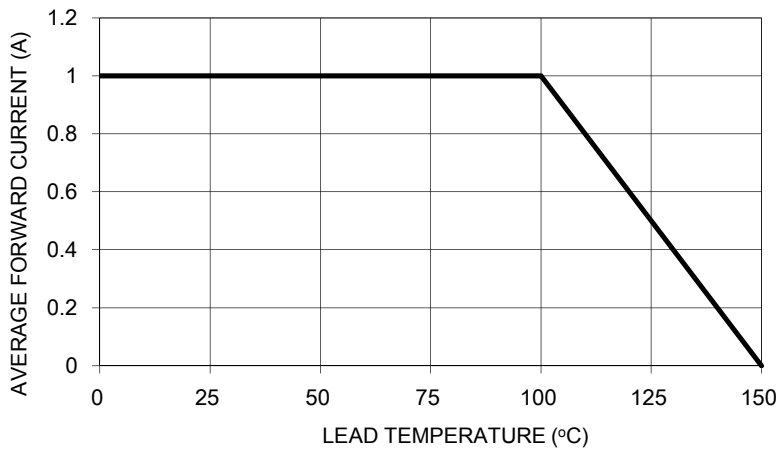

FIG. 2 MAXIMUM FORWARD SURGE CURRENT

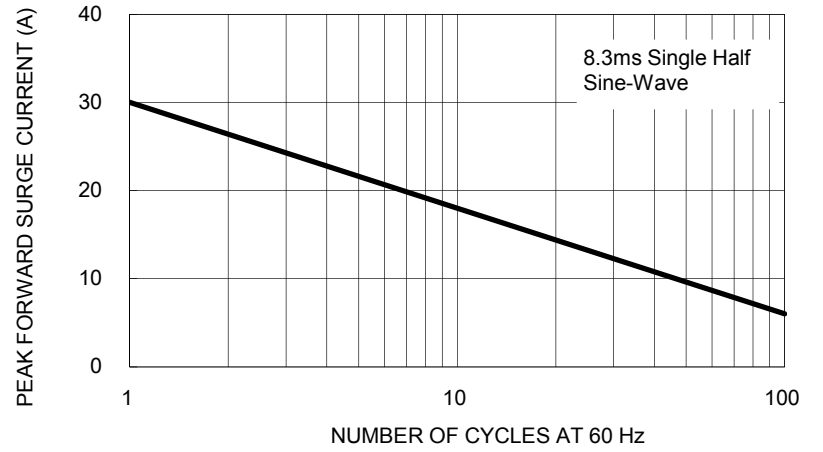

FIG. 3 TYPICAL FORWARD CHARACTERISTICS

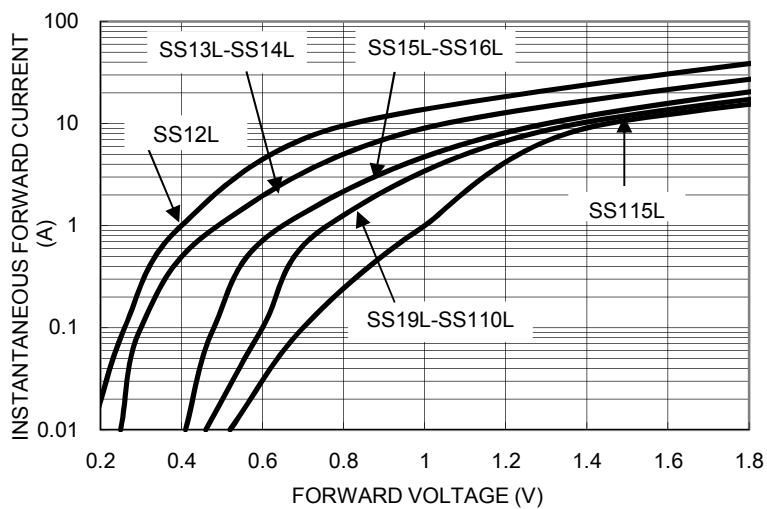

FIG. 4 TYPICAL REVERSE CHARACTERISTICS

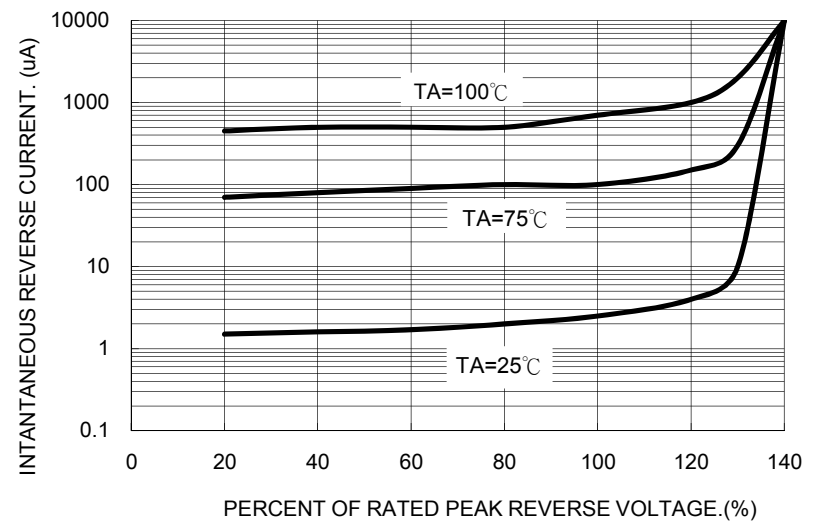

FIG. 5 TYPICAL JUNCTION CAPACITANCE

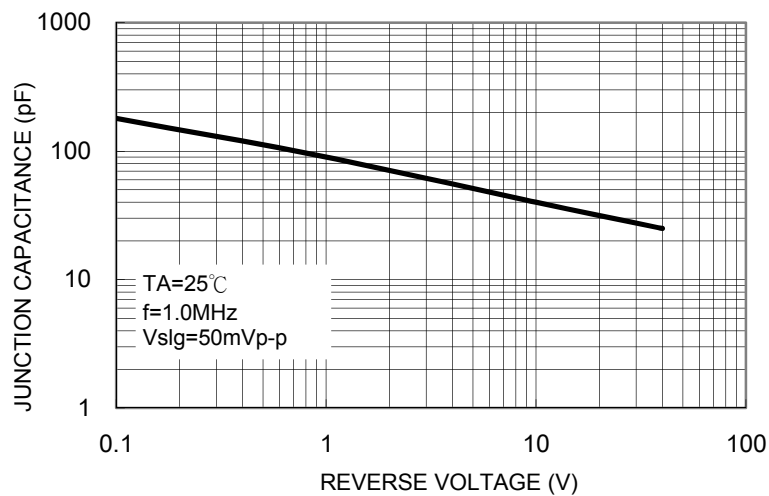
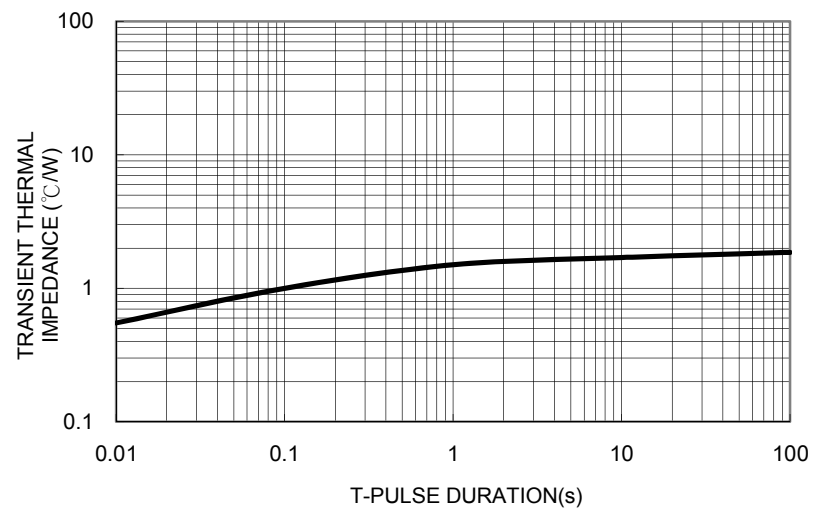

FIG. 6 TYPICAL TRANSIENT THERMAL IMPEDANCE



Ordering information

Part No.	Package	Packing	Tape Size	Packing code	Green Compound Packing code
SS1XL (Note)	Sub-SMA	1.8K / 7" REEL	8mm	RU	RUG
	Sub-SMA	3K / 7" REEL	8mm	RV	RVG
	Sub-SMA	7.5K / 13" REEL	8mm	RT	RTG
	Sub-SMA	7.5K / 13" REEL	8mm	MT	MTG
	Sub-SMA	10K / 13" REEL	8mm	RQ	RQG
	Sub-SMA	10K / 13" REEL	8mm	MQ	MQG
	Sub-SMA	1.8K / 7" REEL	12mm	R3	R3G
	Sub-SMA	3K / 7" REEL	12mm	RF	RFG
	Sub-SMA	7.5K / 13" REEL	12mm	R2	R2G
	Sub-SMA	7.5K / 13" REEL	12mm	M2	M2G
	Sub-SMA	10K / 13" REEL	12mm	RH	RHG
	Sub-SMA	10K / 13" REEL	12mm	MH	MHG

Note: "x" is Device Code from "2" thru "15".

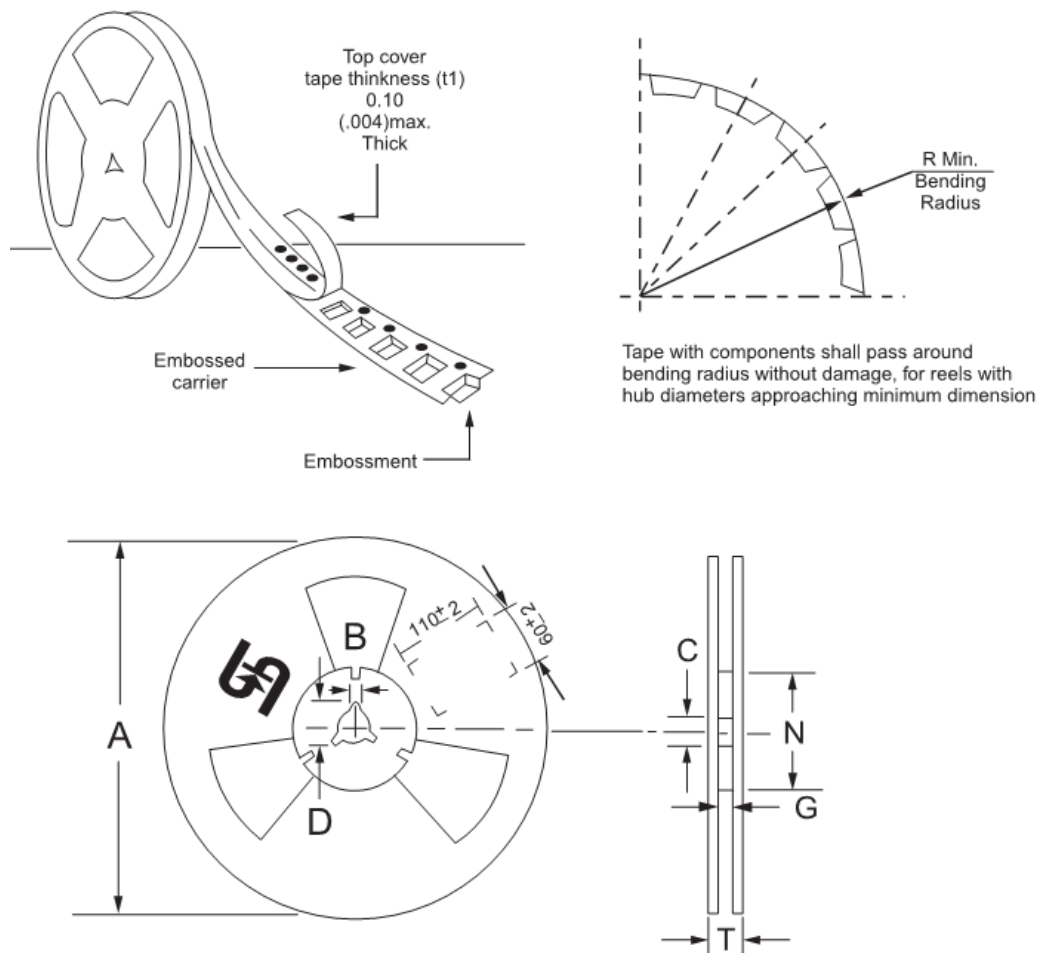
Tape & Reel specification

Reel Size	Tape Size	A	B	C	D	N	G	T
		±2.0	±0.4	+0.5;-0.2	min	±1.0	+0.8;-0	max
7"	8mm	178	1.9	13	21	62	8.2	10.6
	12mm						12.2	14.6
Reel Size	Tape Size	A	B	C	D	N	G	T
		max	±0.5	±0.5	min	±0.5	+2.0;-0	max
13"	8mm	330	2	13	20.2	75	8.5	14.5
	12mm						12.4	18.4

Unit (mm)

Suggested PAD Layout

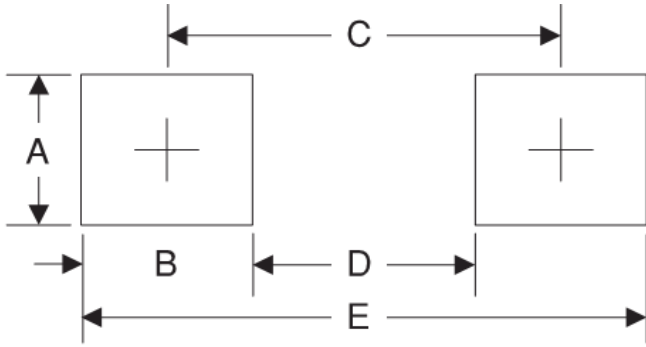

Symbol	Unit(mm)
A	1.4
B	1.2
C	3.1
D	1.9
E	4.3

Package Outline Dimensions

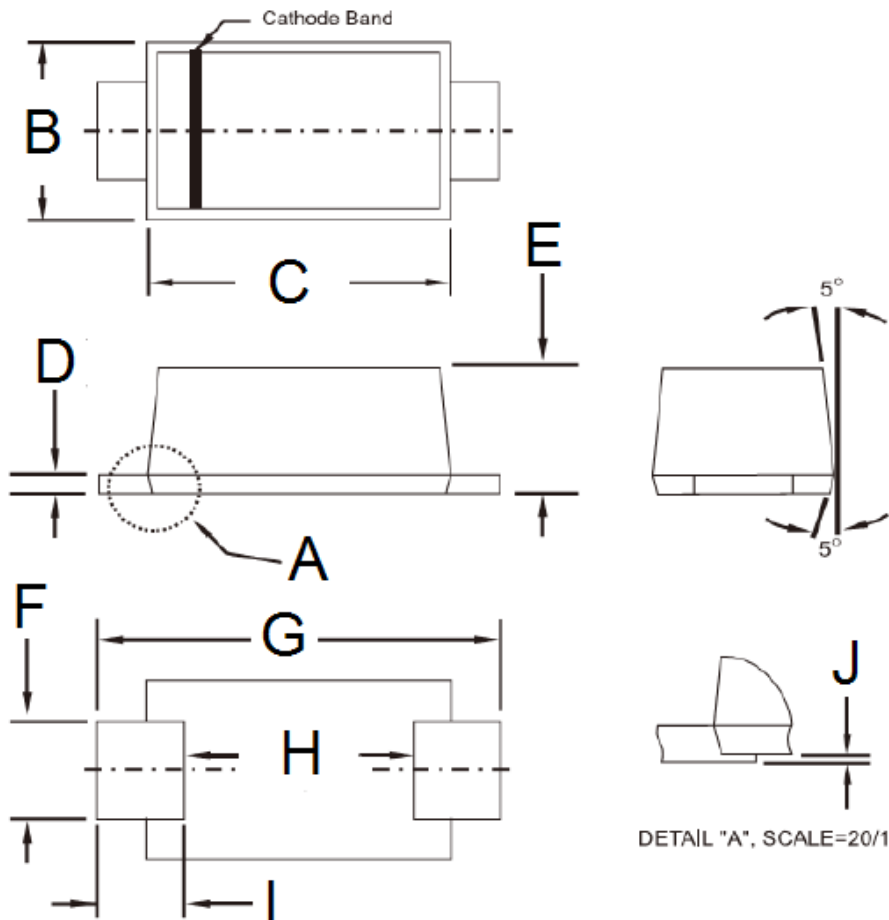

DIM.	Unit(mm)		Unit(inch)	
	Min	Max	Min	Max
B	1.70	1.90	0.067	0.075
C	2.70	2.90	0.106	0.114
D	0.16	0.30	0.006	0.012
E	1.23	1.43	0.048	0.056
F	0.80	1.20	0.031	0.047
G	3.40	3.80	0.134	0.150
H	2.45	2.60	0.096	0.102
I	0.35	0.85	0.014	0.033
J	0.00	0.10	0.000	0.004

Marking Diagram

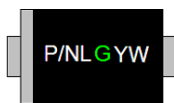

P/NL = Specific Device Code
 G = Green Compound
 YW = Date Code