

# Conductive Sensors

## 2 to 4-point level controller

### Type CL with potentiometer

CARLO GAVAZZI



- Conductive level controller
- Adjustment of sensitivity – operating resistance from 250Ω to 500KΩ
- Multiple combinations of filling and emptying applications
- Low-voltage AC electrodes
- Easy installation on DIN rails or with 11 pin circular plug
- Rated operational voltage: 24 VAC/DC, 115 VAC or 230 VAC
- Output 2x8A/250 VAC SPDT relay
- LED indication for: Output ON and Power ON



## Product Description

μ-Processor based level controller for liquids with a wide sensitivity range (like sewage water, chemicals, salt water etc.). The controller has a separate output for alarm indication in case of a tank

running dry or if an overflow condition occurs. 8A SPDT/SPST relay output, NO/NC. Sensitivity control by potentiometer level in 3 ranges.

## Ordering Key

**CLD4MA2DM24**

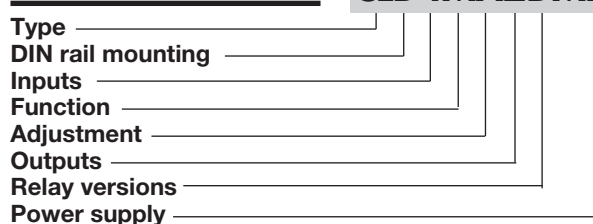

## Type Selection

Mounting	Relay	Ordering no. Supply: 24 VAC/DC	Ordering no. Supply: 115 VAC	Ordering no. Supply: 230 VAC
DIN-rail	SPDT + SPST	CLD4MA2DM24	CLD4MA2D115	CLD4MA2D230
11-p circular plug	2 SPST	CLP4MA2AM24	CLP4MA2A115	CLP4MA2A230

## Specifications

<b>Rated operational voltage (U<sub>B</sub>)</b>					
Pin 2 & 10	230	195 to 265 VAC, 45 to 65 Hz			Ranges H (High sensitivity)
	115	98 to 132 VAC, 45 to 65 Hz			50 KΩ to 500 KΩ, C <sub>F</sub> * = 1.0 nF
Supply class 2	24	19.2 to 28.8 VAC/DC			<b>Dielectric voltage</b>
Rated insulation voltage		<2.0 kVAC (rms)			>2.0 KVAC (rms)
Rated impulse withstand voltage		4 kV (1.2/50 μs) (line/neutral)			(contacts / electronics)
<b>Rated operational power</b>					<b>Rated impulse withstand volt.</b>
AC supply	5 VA				4 kV (1.2/50 μs) (contacts / electronics) (IEC 664)
AC/DC supply	5 VA / 5 W				<b>Operating frequency (f)</b>
<b>Delay on operate (t<sub>v</sub>)</b>	< 300 mS				Relay output
<b>Outputs</b>					0.5 HZ
Rated insulation voltage		Make or break on rotary-switch			<b>Response time</b>
		250 VAC (rms) (cont./elec.)			OFF-ON (t <sub>on</sub> )
					1 s
					ON-OFF (t <sub>off</sub> )
					1 s
<b>Relay Rating (AgCdO)</b>					<b>Environment</b>
Resistive loads	AC1	μ (micro gap)			Overvoltage category
	DC1	8 A / 250 VAC (2500 VA)			III (IEC 60664)
		1 A / 250 VDC (250 W)			Degree of protection
		or 10 A / 25 VDC (250 W)			IP 20 (IEC 60529, 60947-1)
Small induc. Loads	AC15	0,4 A / 250 VAC			Pollution degree
	DC13	0,4 A / 30 VDC			2 (IEC 60664/60664A, 60947-1)
Mechanical life (typical)		≥ 30 x 10 <sup>6</sup> operations			<b>Temperature</b>
		@ 18'000 imp/h			Operating
Electrical life (typical)	AC1	> 250'000 operations			-20° to +50°C (-4° to + 122°F)
					Storage
					-50° to +85°C (-58° to +185°F)
<b>Level probe supply</b>		Max. 5 VAC			<b>Housing material</b>
<b>Level probe current</b>		Max. 2 mA			CLP
<b>Sensitivity</b>		250Ω to 500KΩ			CLD
		Factory settings standard range "S" 100KΩ			NORYL PPO, light grey
		250 Ω to 5 KΩ, C <sub>F</sub> * = 4.7 nF			ABS VO, light grey
		5 KΩ to 100 KΩ, C <sub>F</sub> * = 2.2 nF			<b>Weight</b>
Ranges L (Low sensitivity)					AC supply
Ranges S (Standard sensitivity)					200 g
					AC/DC supply
					125 g
					<b>UL Approvals</b>
					cURus
					UL508, UL325, CSA-C22.2 No.247
					<b>CE marking</b>
					Yes

Specifications are subject to change without notice (20.05.2014)

\*C<sub>F</sub> = maximum Cable Capacitance

## Mode of Operation

### Connection cable

2, 3, 4 or 5 conductor PVC cable, normally screened. Cable length: max. 100 m. The resistance between the cores and the ground must be at least 500k. Normally, it is recommended to use a screened cable between probe and controller, e.g. where the cable is placed in parallel to the load cables (mains). The screen has to be connected to Y5 (reference).

### Example 1

The diagram shows the level control connected as max. and min. control, i.e. registration of 2 levels + 2 alarm levels. The relays

react to the low current created when the electrodes are in contact with the liquid.

The reference (Ref) must be connected to the container or if the container consists of a non-conductive material, to an additional electrode. (To be connected to pin Y5).

In the diagram this electrode is shown by the dotted line.)

The alarm outputs utilize alarm - and Y1 for LoLo alarm - and Y4 for HiHi alarm outputs.

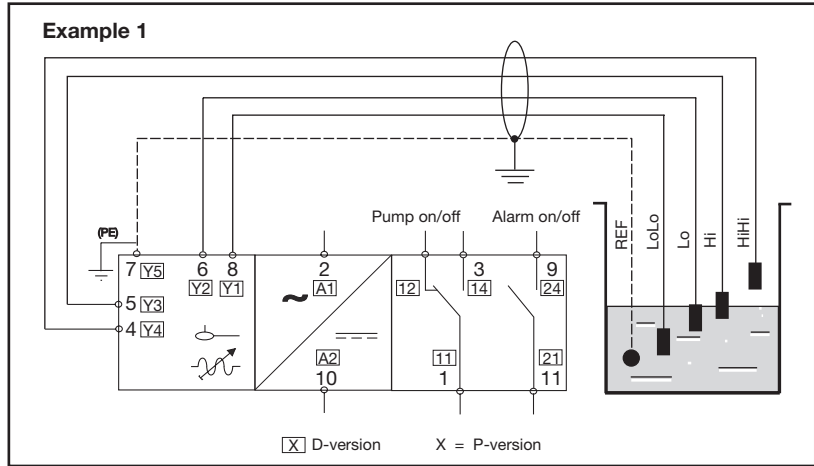

## Operation Diagram

### Function: Filling or Emptying

The Multifunction Controller can be used as a minimum-maximum control for two systems, a filling system and a emptying system, with the same kind of liquid to be measured and one common pump.

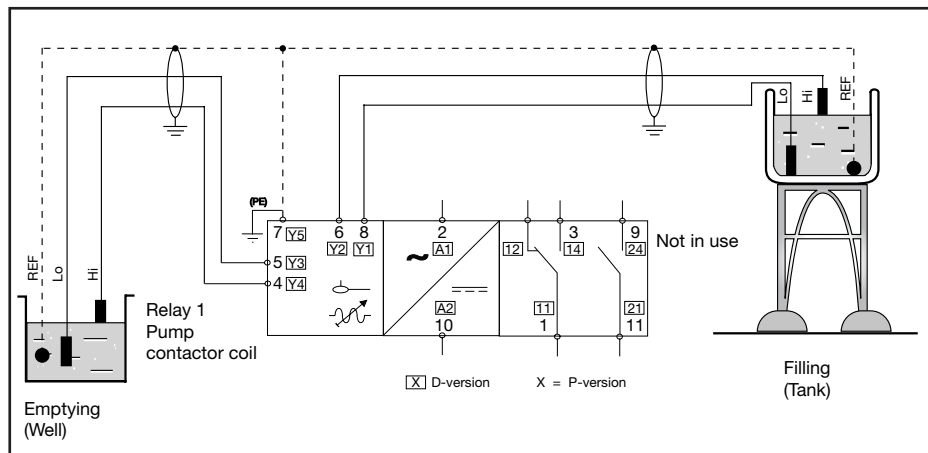

### Tank-Well application (Filling and emptying)

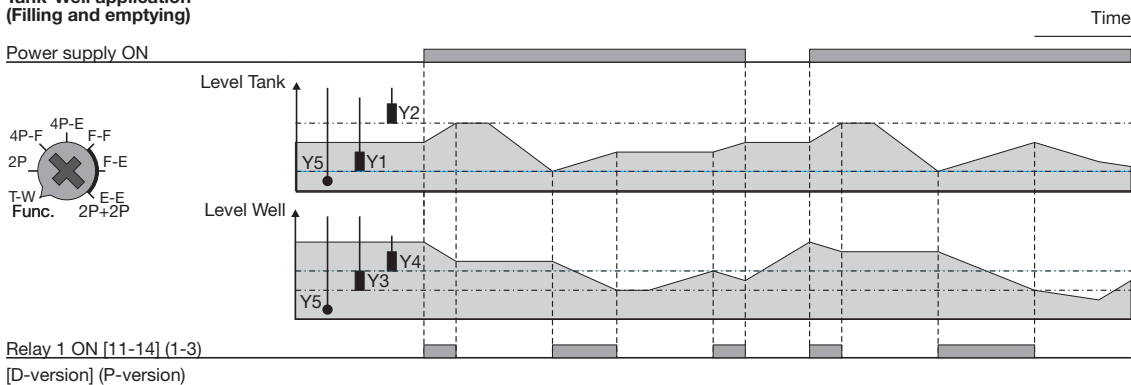

## Operation Diagram

**Function: Direct input- output**  
 The Multifunction Controller can be used as direct input/ output, where each of the two inputs (electrodes) controls an individual relay output:  
 Electrode no. 1 = Relay no. 1  
 Electrode no. 2 = Relay no. 2.

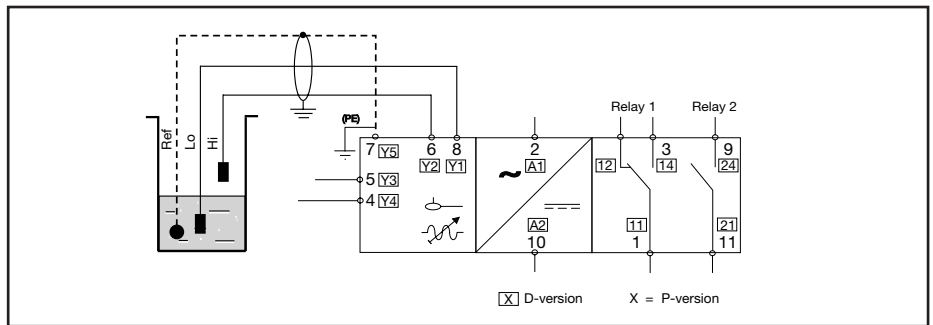

**2-Probe (Direct Input to output)**

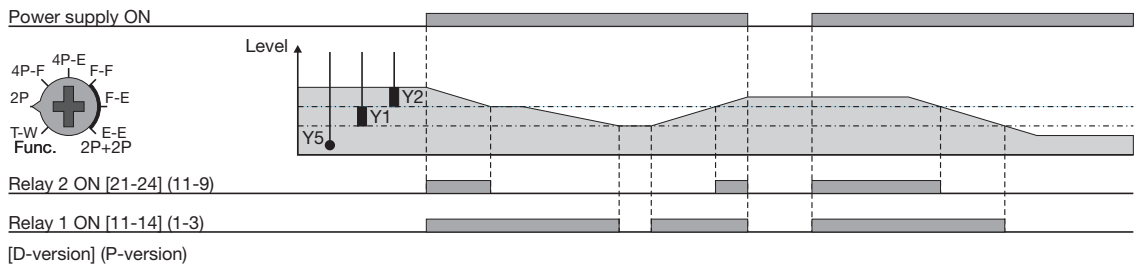

**Function: Filling or Emptying with high and low alarms**  
 The Multifunction Controller can be used as a minimum-maximum control filling or emptying system, with HiHi and LoLo Alarm output.

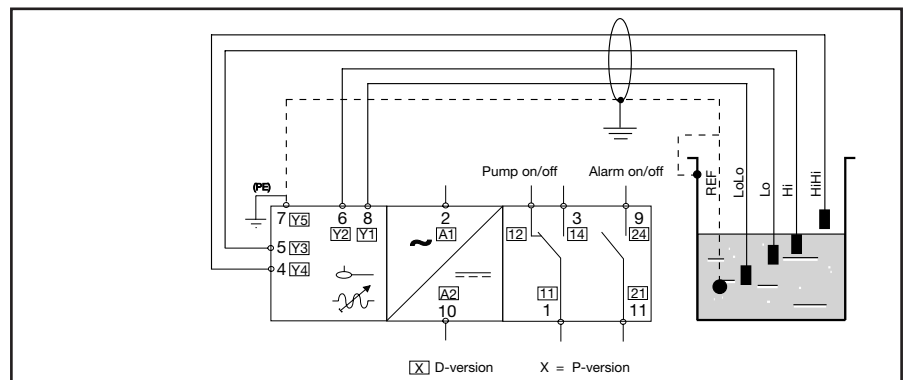

**4-Probe Filling (Low and High alarm)**

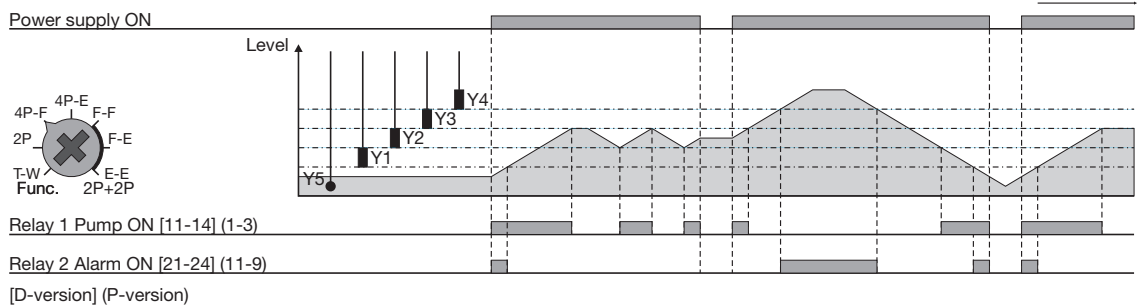

**4-Probe Emptying (Low and High alarm)**

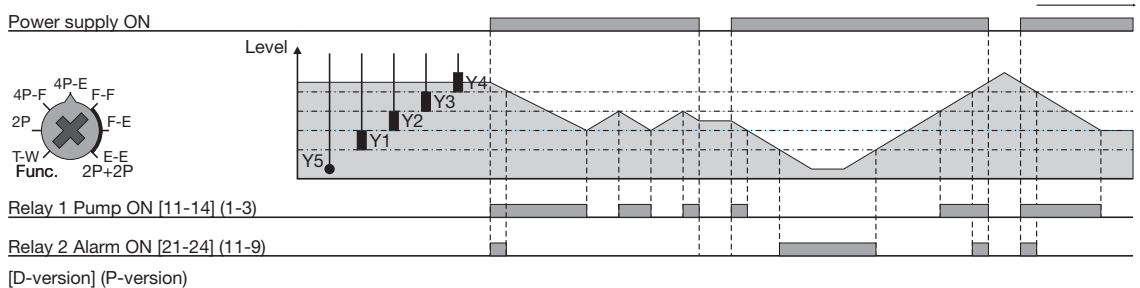

## Operation Diagram

**Function: Filling or Emptying**  
 The Multifunction Controller can be used as a minimum-maximum control for up to two individual systems, with the same kind of liquid to be measured.

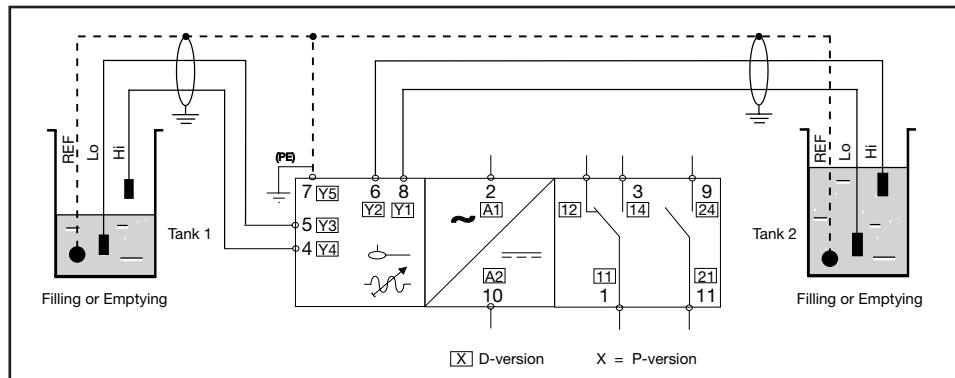

### 2 Individual systems (Filling and/or emptying)

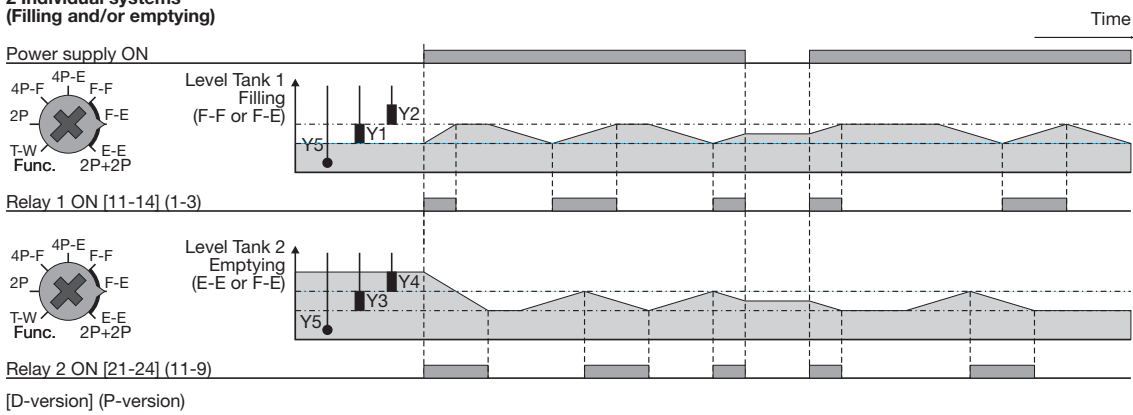

## Wiring Diagram

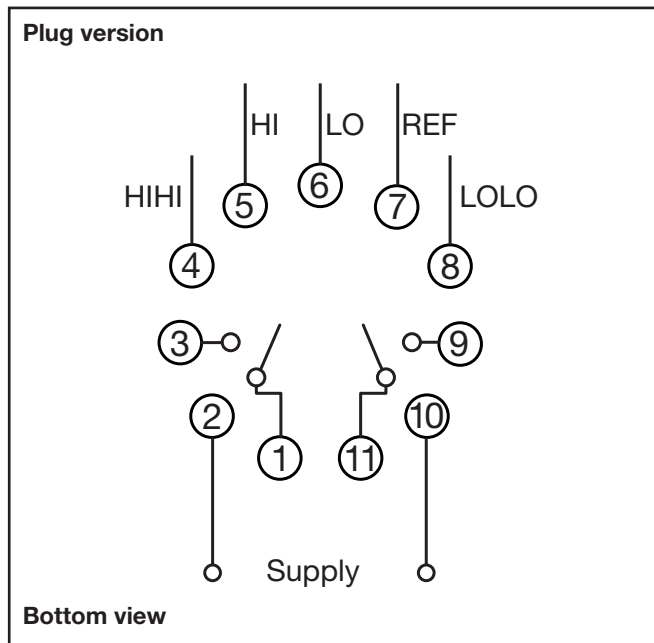
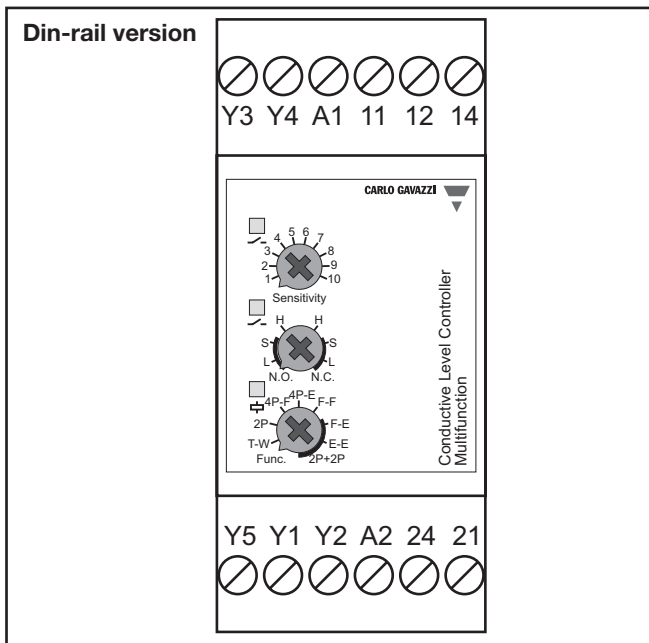

## Dimension Drawings

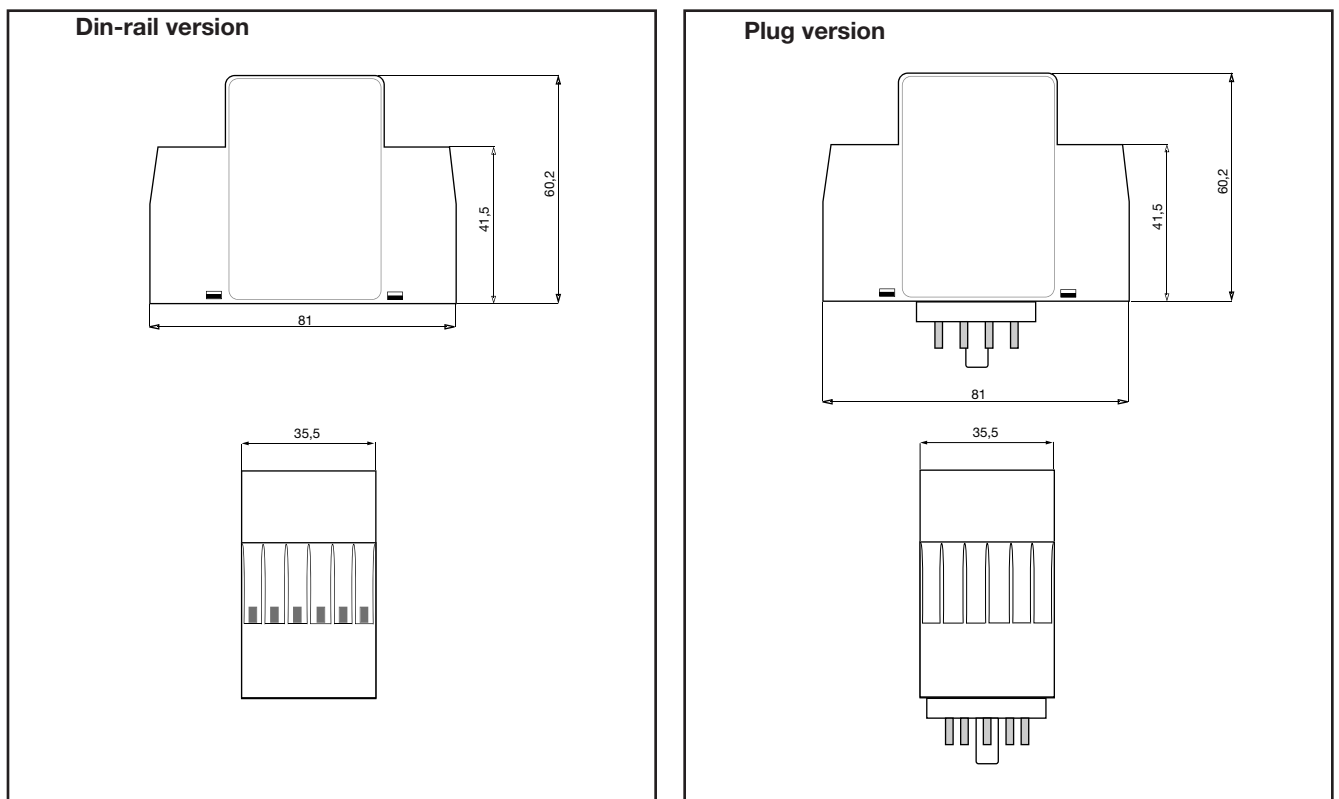

## Accessories

- 11 pole circular socket ZPD11
- Retaining spring HF

## Delivery Contents

- Amplifier
- Packaging: Carton box
- Manual