

DISPLAY Elektronik GmbH

DATA SHEET

LCD MODULE

DEM 128032A SBH-PW-N

Product Specification

Version: 2

02/December/2008

GENERAL SPECIFICATION

MODULE NO. :

DEM 128032A SBH-PW-N

VERSION NO.	CHANGE DESCRIPTION	DATE
0	ORIGINAL VERSION	28.10.2008
1	UPDATE Bias & V_{LCD}	27.11.2008
2	UPDATE MODULE DRAWING	02.12.2008

PREPARED BY: XYP

DATE: 02.12.2008

APPROVED BY: MH

DATE: 02.12.2008

CONTENTS

1. FUNCTIONS & FEATURES2

2. MECHANICAL SPECIFICATIONS.....2

3. EXTERNAL DIMENSIONS.....3

4. BLOCK DIAGRAM.....4

5. PIN DESCRIPTION.....5

6. ABSOLUTE MAXIMUM RATINGS6

7. BACKLIGHT CHARACTERISTICS6

8. ELECTRICAL CHARACTERISTICS7

9. COMMAND TABLE 11

10. LCD ARTWORK.....12

11. LCD LABELING12

12. SEG LAYOUT.....13

13. COM LAYOUT.....13

14. PAD CONFIGURATION GRAPHIC DIMENSION14

15. IC LAYOUT14

16. LCD MODULES HANDLING PRECAUTIONS.....15

17. OTHERS.....15

1. FUNCTIONS & FEATURES

MODULE NAME	LCD TYPE
DEM 128032A SBH-PW-N	STN-BLUE Transmissive Negative Mode

- LCD-TYPE : COG-Display, 128x32 Dots
- Viewing Direction : 6 o'clock
- Driving Scheme : 1/64 Duty Cycle, 1/9 Bias
- Power Supply Voltage(Typ.) : 3.0 Volt (typ.)
- LCD Operation Voltage : 9.8 Volt (typ.)
- Backlight color : LED, Lightguide, White
- Driver IC : ST7565R-G (Sitronix)
- Operating Temperature : -20°C to +70°C
- Storage Temperature : -30°C to +80°C

2. MECHANICAL SPECIFICATIONS

- Module Size: : 60.00 x 30.00 x 7.96 mm
- Viewing Area Size: : 54.80 x 16.56 mm
- Active Area Size : 51.17 x 12.77 mm
- Dot pitch: : 0.40 x 0.40 mm
- Dot Size: : 0.37 x 0.37 mm

3. EXTERNAL DIMENSIONS

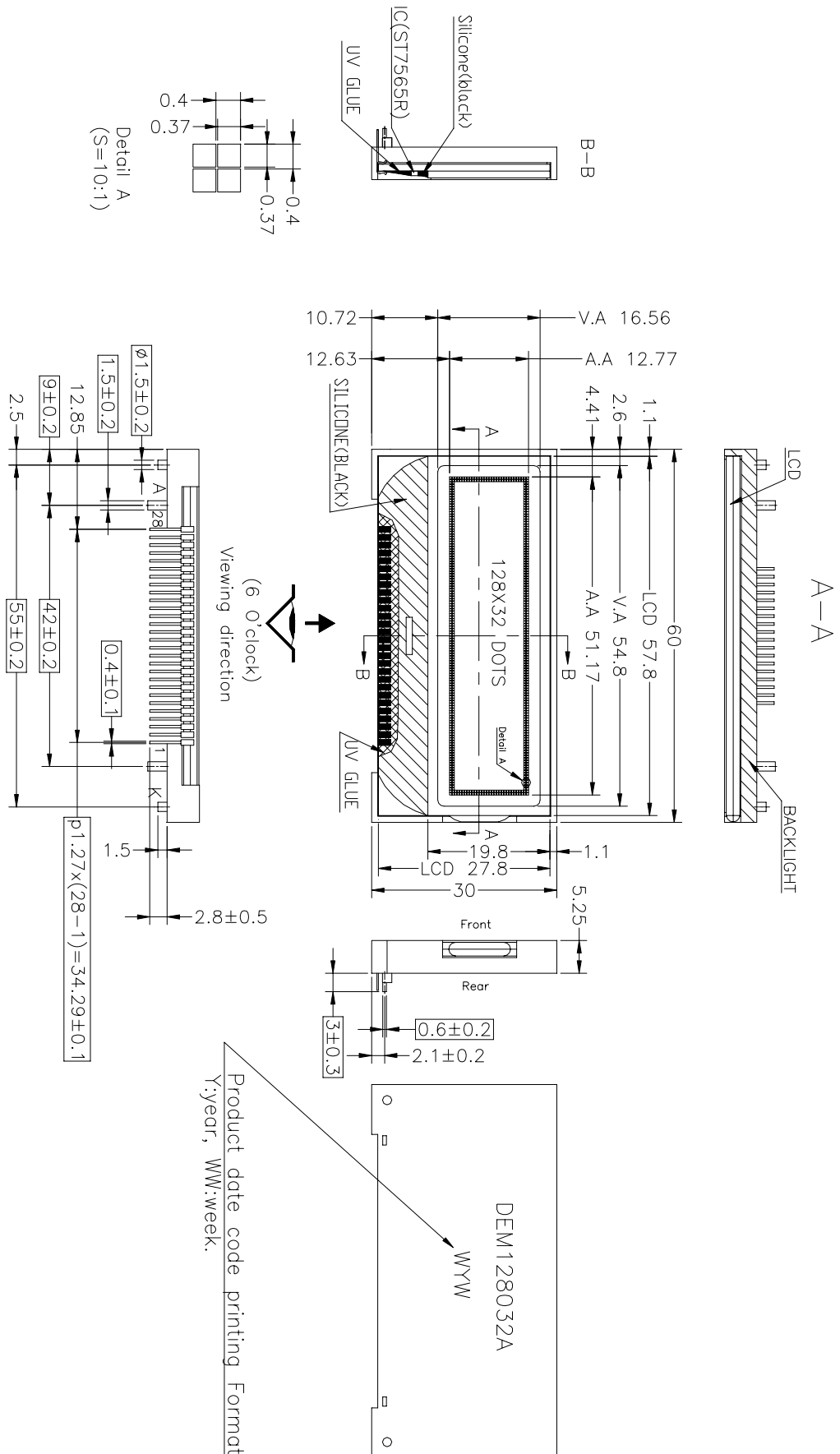

- Remarks:
1. Unmarked tolerance is ± 0.30 ;
 2. All material comply with RoHs.

4. BLOCK DIAGRAM

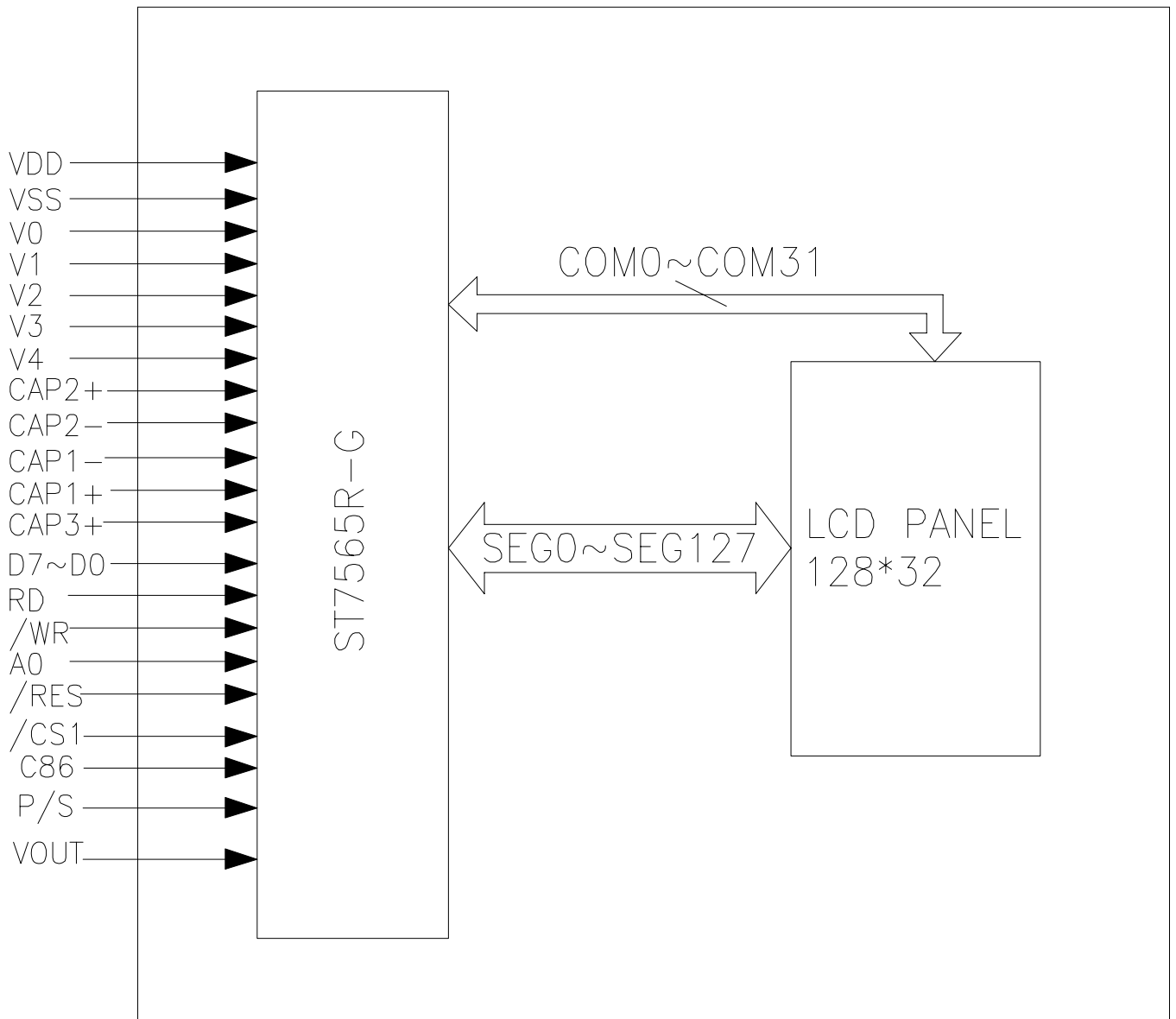

5. PIN DESCRIPTION

Pin No.	Name	I/O	Description																
1	/CS1	I	Chip enable terminal. It is active when /CS="L".																
2	/RES	I	When /RES is set to "L", the register settings are initialized (cleared). The reset operation is performed by the /RES signal level.																
3	A0	I	This is connect to the least significant bit of the normal MPU address bus, and it determines whether the data bits are data or command. A0 = "H": Indicates that D0 to D7 are display data. A0 = "L": Indicates that D0 to D7 are control data.																
4	R/W	I	When connected to 6800 series MPU, this pin is treated as the "R/W" signal of the 6800 MPU and decides the access type : When R/W = "H": Read. When R/W = "L": Write																
5	R/D	I	This is the enable clock input terminal of the 6800 Series MPU and is HIGH-active.																
6~13	D7~D0	I/O	This is an 8-bit bi-directional data bus that connects to an 8-bit or 16-bit standard MPU data bus.																
14	VDD	Supply	Power supply for logic.																
15	VSS	Supply	Ground.																
16	Vout	Supply	DC/DC voltage converter. Connect a capacitor between this terminal and VSS or VDD terminal.																
17	C3+	O	DC/DC voltage converter. Connect a capacitor between this terminal and the C1- terminal.																
18	C1-	O	DC/DC voltage converter. Connect a capacitor between this terminal and the C1+ terminal.																
19	C1+	O	DC/DC voltage converter. Connect a capacitor between this terminal and the C1- terminal.																
20	C2+	O	DC/DC voltage converter. Connect a capacitor between this terminal and the C2- terminal.																
21	C2-	O	DC/DC voltage converter. Connect a capacitor between this terminal and the C2+ terminal.																
22	V4	Supply	This is a multi-level power supply for the liquid crystal drive. The voltage Supply applied is determined by the liquid crystal cell, and is changed through the use of a resistive voltage divided or through changing the impedance using an op.amp. Voltage levels are determined based on Vss, and must maintain the relative magnitudes shown below. V0≥V1≥V2≥V3≥V4≥VSS																
23	V3																		
24	V2																		
25	V1																		
26	V0																		
27	C86	I	This is the MPU interface switch terminal C86="H" : 6800 series MPU interface C86="L" : 8080 MPU interface																
28	P/S	I	This pin configures the interface to be parallel mode or serial mode. P/S = "H": Parallel data input/output. P/S = "L": Serial data input. The following applies depending on the P/S status:																
				<table border="1"> <thead> <tr> <th>P/S</th> <th>Data/Command</th> <th>Data</th> <th>Read/Write</th> <th>4-lineSPI Clock</th> </tr> </thead> <tbody> <tr> <td>"H"</td> <td>A0</td> <td>D0 to D7</td> <td>/RD, /WR</td> <td>x</td> </tr> <tr> <td>"L"</td> <td>A0</td> <td>SI (D7)</td> <td>Write only</td> <td>SCL (D6)</td> </tr> </tbody> </table>	P/S	Data/Command	Data	Read/Write	4-lineSPI Clock	"H"	A0	D0 to D7	/RD, /WR	x	"L"	A0	SI (D7)	Write only	SCL (D6)
				P/S	Data/Command	Data	Read/Write	4-lineSPI Clock											
"H"	A0	D0 to D7	/RD, /WR	x															
"L"	A0	SI (D7)	Write only	SCL (D6)															
When P/S = "L", D0 to D5 must be fixed to "H". /RD (E) and /WR (R/W) are fixed to either "H" or "L". The serial access mode does NOT support read operation.																			

A	Supply voltage for backlight LED+
K	Supply voltage for backlight LED-

6. ABSOLUTE MAXIMUM RATINGS

Parameter	Symbol	Conditions	Unit
Power Supply Voltage	VDD	-0.3 ~ 3.6	V
Power supply voltage (VDD standard)	V0, VOUT	-0.3 ~ 13.5	V
Power supply voltage (VDD standard)	V1, V2, V3, V4	-0.3 to V0	V
Operating temperature	TOPR	-20 to +70	°C
Storage temperature	TSTR	-30 to +80	°C

7. BACKLIGHT CHARACTERISTICS

Item	Symbol	min.	typ.	max.	Unit	Condition
Forward Voltage	Vf	3.0	3.2	3.4	V	If= 60 mA
Power Dissipation	Pd	-	-	204	mW	If= 60 mA
Luminous Uniformity	ΔLv	70			%	MIN/MAX*100%
Luminance	Lv		250		cd/m ²	If= 60 mA T=25°C
Color Coordinate	X	0.240		0.330		
	Y	0.240		0.330		
Peak wave length	λP	-	-	-	nm	

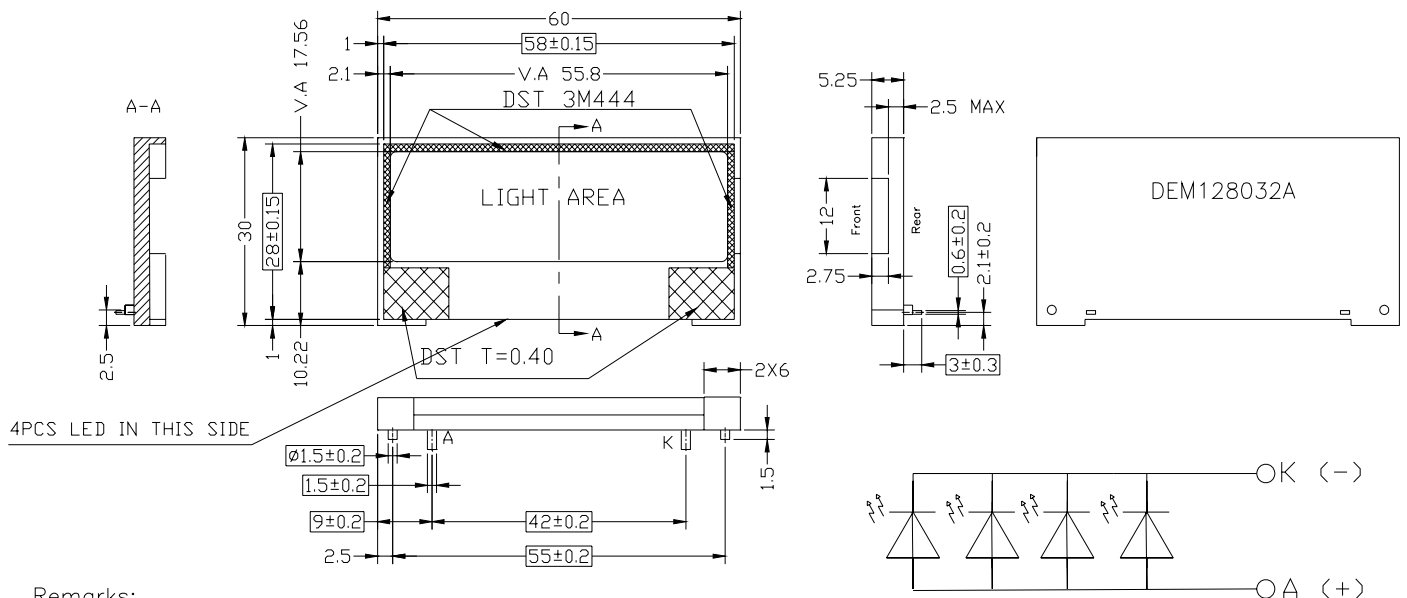

8. ELECTRICAL CHARACTERISTICS

8.1. DC CHARACTERISTICS

Item	Symbol	Condition	STANDARD VALUE			units
			Min.	Typ.	Max.	
Operating Voltage	VDD	Relative to VSS	2.7	3.0	3.3	V
LCD driving voltage	VLCD	Relative to VSS	9.6	9.8	10	
Consumption current	IDD	-	-	TBD	-	mA

8.2. AC CHARACTERISTICS

System Bus Read/Write Characteristics 1 (For the 8080 Series MPU)

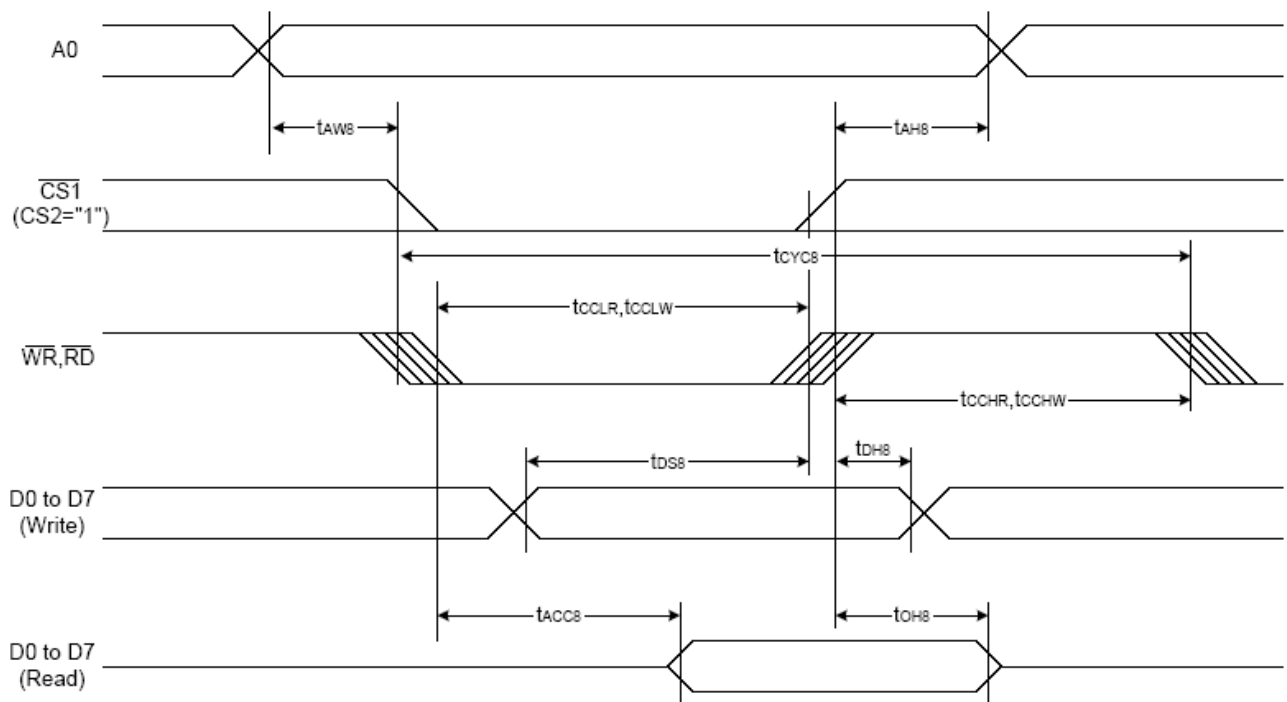

(VDD=3.0V TA=25°C)

Item	Signal	Symbol	Condition	Rating		Units
				Min.	Max.	
Address hold time	A0	t _{AH8}		0	—	Ns
Address setup time		t _{AW8}		0	—	
System cycle time		t _{CYC8}		240	—	
Enable L pulse width (WRITE)	WR	t _{CCLW}		80	—	
Enable H pulse width (WRITE)		t _{CCHW}		80	—	
Enable L pulse width (READ)	RD	t _{CCLR}		140	—	
Enable H pulse width (READ)		t _{CCHR}		80	—	
WRITE Data setup time	D0 to D7	t _{DS8}		40	—	
WRITE Address hold time		t _{DH8}		0	—	
READ access time		t _{ACC8}	CL = 100 pF	—	70	
READ Output disable time		t _{OH8}	CL = 100 pF	5	50	

System Bus Read/Write Characteristics 2 (For the 6800 Series MPU)

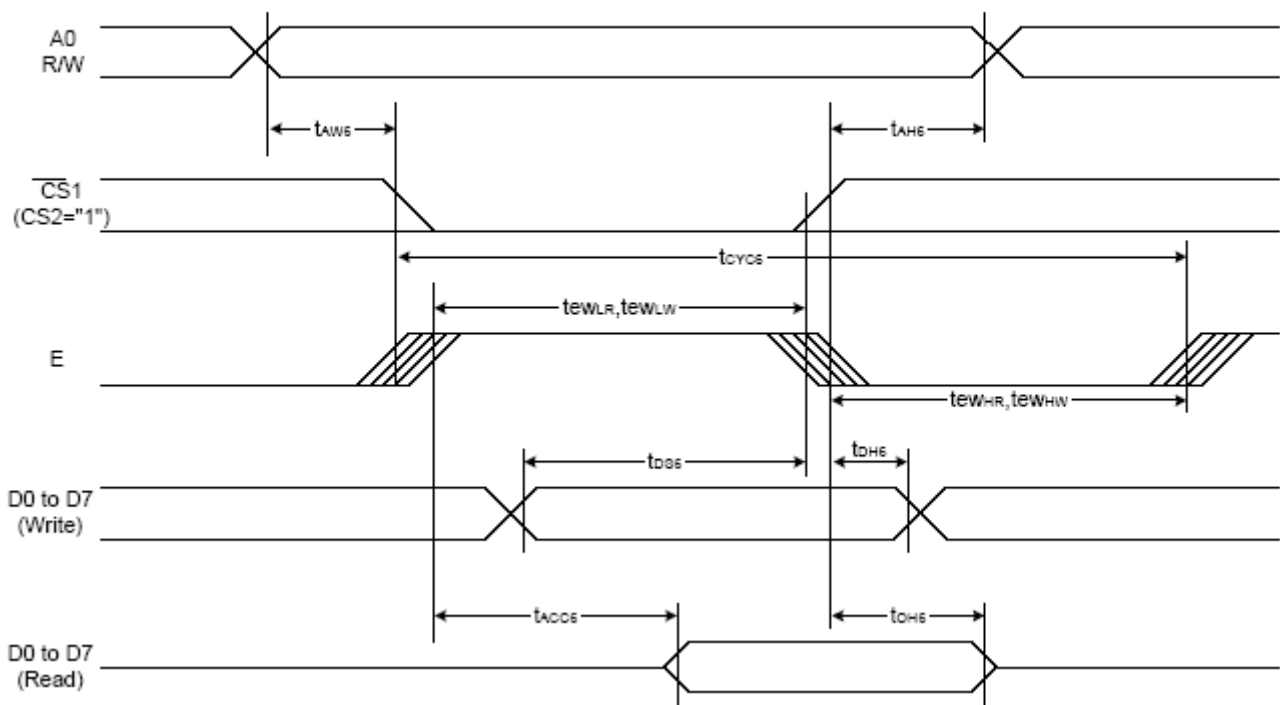

(VDD=3.0V TA=25°C)

Item	Signal	Symbol	Condition	Rating		Units
				Min.	Max.	
Address hold time	A0	tAH6		0	—	ns
Address setup time		tAW6		0	—	
System cycle time		tCYC6		240	—	
Enable L pulse width (WRITE)	WR	tEWLW		80	—	
Enable H pulse width (WRITE)		tEWHW		80	—	
Enable L pulse width (READ)	RD	tEWLR		80	—	
Enable H pulse width (READ)		tEWHR		140	—	
WRITE Data setup time	D0 to D7	tDS6		40	—	
WRITE Address hold time		tDH6		0	—	
READ access time		tACC6	CL = 100 pF	—	70	
READ Output disable time		tOH6	CL = 100 pF	5	50	

The 4-line SPI Interface

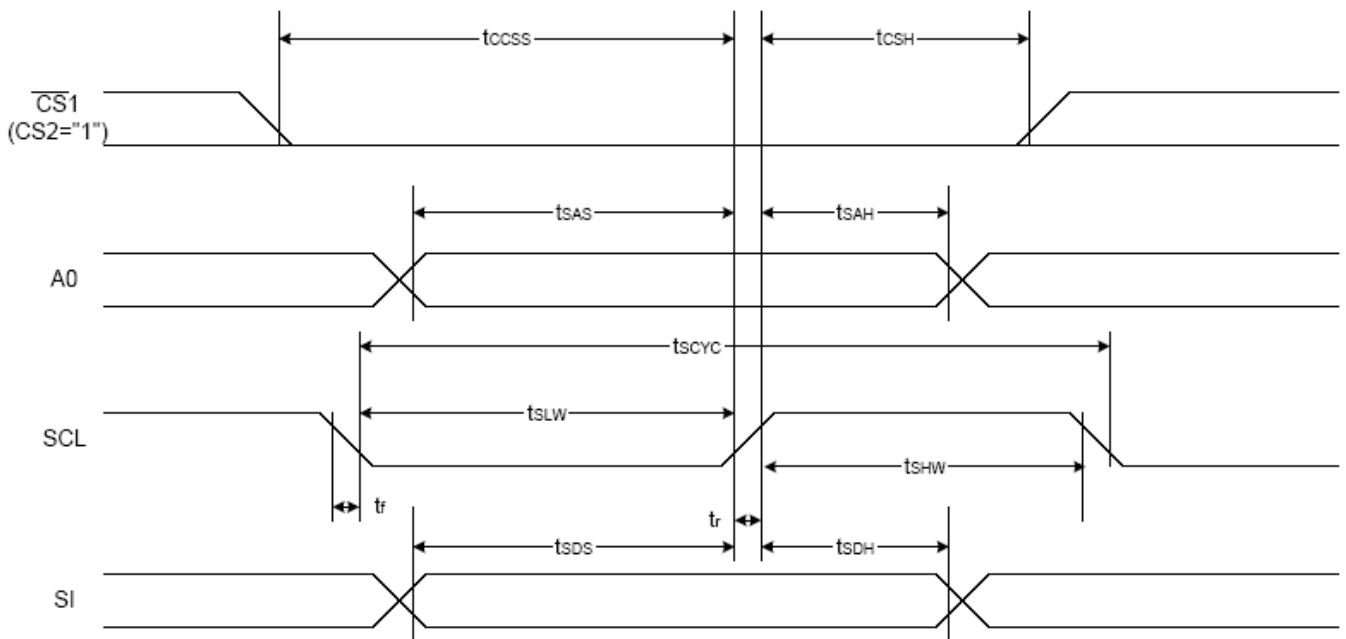

(VDD=3.0V TA=25°C)

Item	Signal	Symbol	Condition	Rating		Units
				Min.	Max.	
4-line SPI Clock Period	SCL	T_{scyc}		50	—	ns
SCL "H" pulse width		T_{shw}		25	—	
SCL "L" pulse width		T_{SLW}		25	—	
Address setup time	A0	T_{SAS}		20	—	
Address hold time		T_{SAH}		10	—	
Data setup time	SI	T_{SDS}		20	—	
Data hold time		T_{SDH}		10	—	
CS-SCL time	CS	T_{CSS}		20	—	
CS-SCL time		T_{CSH}		40	—	

Reset Timing

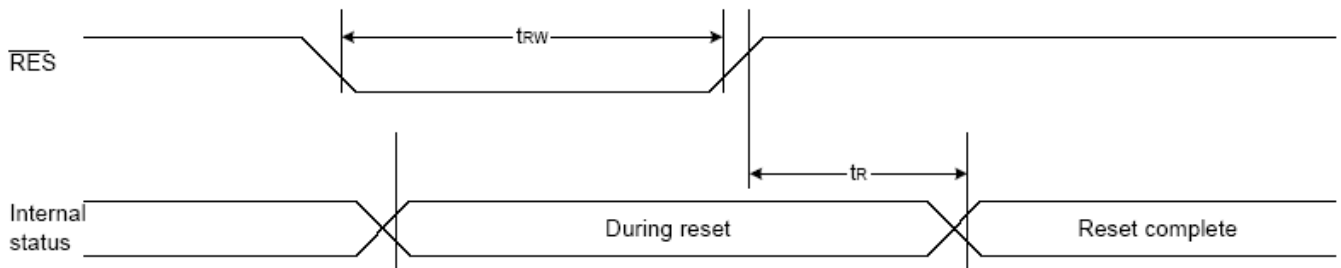

Item	Signal	Symbol	Condition	Rating			Units
				Min.	Typ.	Max.	
Reset time		t_R		—	—	1.0	us
Reset "L" pulse width	/RES	t_{RW}		1.0	—	—	us

9. COMMAND TABLE

(COMMAND FOR ST7565R)

Command	Command Code									Function			
	A0	/RD	/WR	D7	D6	D5	D4	D3	D2		D1	D0	
(1) Display ON/OFF	0	1	0	1	0	1	0	1	1	1	0	1	LCD display ON/OFF 0: OFF, 1: ON
(2) Display start line set	0	1	0	0	1	Display start address						0	Sets the display RAM display start line address
(3) Page address set	0	1	0	1	0	1	1	Page address				0	Sets the display RAM page address
(4) Column address set upper bit Column address set lower bit	0	1	0	0	0	0	1	Most significant column address				0	Sets the most significant 4 bits of the display RAM column address. Sets the least significant 4 bits of the display RAM column address.
				0	0	0	0	Least significant column address				0	
(5) Status read	0	0	1	Status				0	0	0	0	0	Reads the status data
(6) Display data write	1	1	0	Write data							0	Writes to the display RAM	
(7) Display data read	1	0	1	Read data							0	Reads from the display RAM	
(8) ADC select	0	1	0	1	0	1	0	0	0	0	0	1	Sets the display RAM address SEG output correspondence 0: normal, 1: reverse
(9) Display normal/reverse	0	1	0	1	0	1	0	0	1	1	0	1	Sets the LCD display normal/ reverse 0: normal, 1: reverse
(10) Display all points ON/OFF	0	1	0	1	0	1	0	0	1	0	0	1	Display all points 0: normal display 1: all points ON
(11) LCD bias set	0	1	0	1	0	1	0	0	0	1	0	1	Sets the LCD drive voltage bias ratio 0: 1/9 bias, 1: 1/7 bias (ST7565R)
(12) Read-modify-write	0	1	0	1	1	1	0	0	0	0	0	0	Column address increment At write: +1 At read: 0
(13) End	0	1	0	1	1	1	0	1	1	1	0	0	Clear read/modify/write
(14) Reset	0	1	0	1	1	1	0	0	0	1	0	0	Internal reset
(15) Common output mode select	0	1	0	1	1	0	0	0	*	*	*	*	Select COM output scan direction 0: normal direction 1: reverse direction
(16) Power control set	0	1	0	0	0	1	0	1	Operating mode			0	Select internal power supply operating mode
(17) V ₀ voltage regulator internal resistor ratio set	0	1	0	0	0	1	0	0	Resistor ratio			0	Select internal resistor ratio(Rb/Ra) mode
(18) Electronic volume mode set Electronic volume register set	0	1	0	1	0	0	0	0	0	0	0	1	Set the V ₀ output voltage electronic volume register
				0	0	Electronic volume value						0	
(19) Static indicator ON/OFF Static indicator register set	0	1	0	1	0	1	0	1	1	0	0	0	0: OFF, 1: ON Set the flashing mode
				0	0	0	0	0	0	0	0	Mode	
(20) Booster ratio set	0	1	0	1	1	1	1	1	0	0	0	0	select booster ratio 00: 2x,3x,4x 01: 5x 11: 6x
(21) Power save	0	1	0	step-up value							0	Display OFF and display all points ON compound command	
(22) NOP	0	1	0	1	1	1	0	0	0	1	1	1	Command for non-operation
(23) Test	0	1	0	1	1	1	1	*	*	*	*	*	Command for IC test. Do not use this command

10. LCD ARTWORK

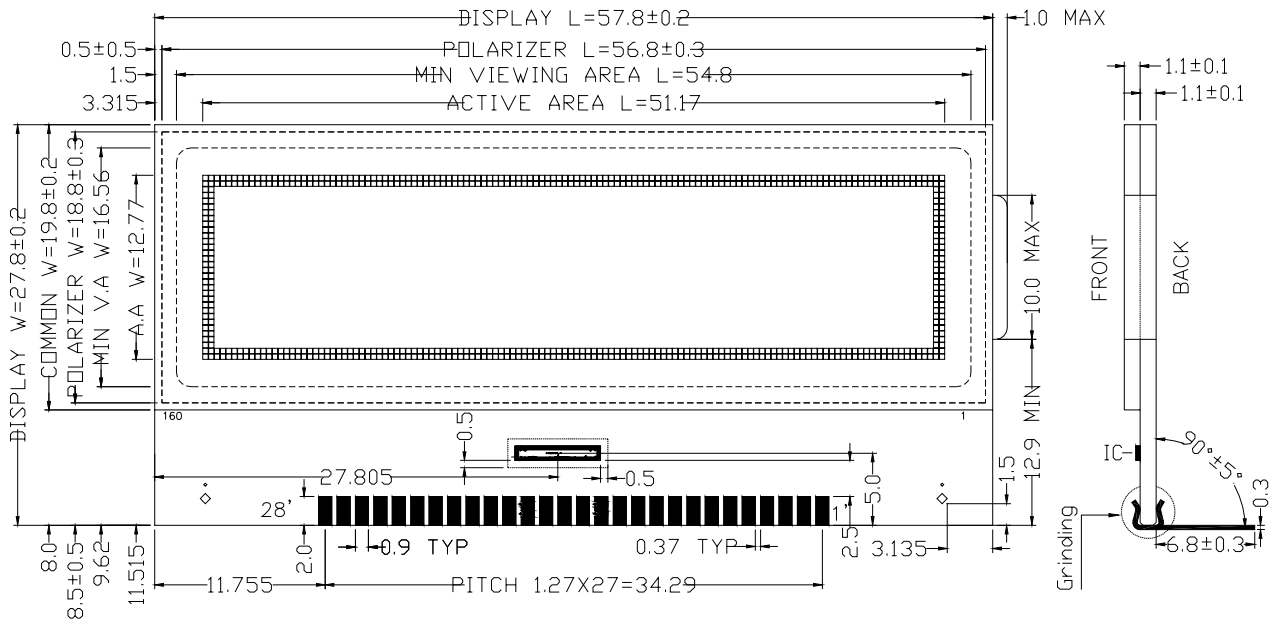

11. LCD LABELING

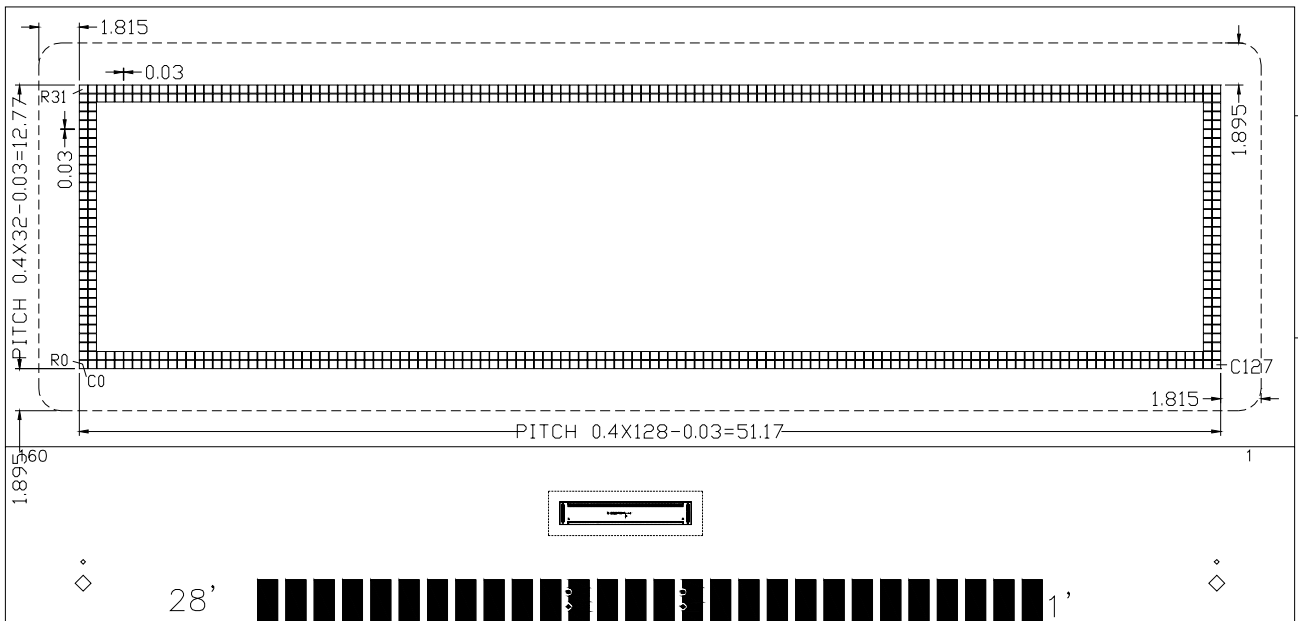

12. SEG LAYOUT

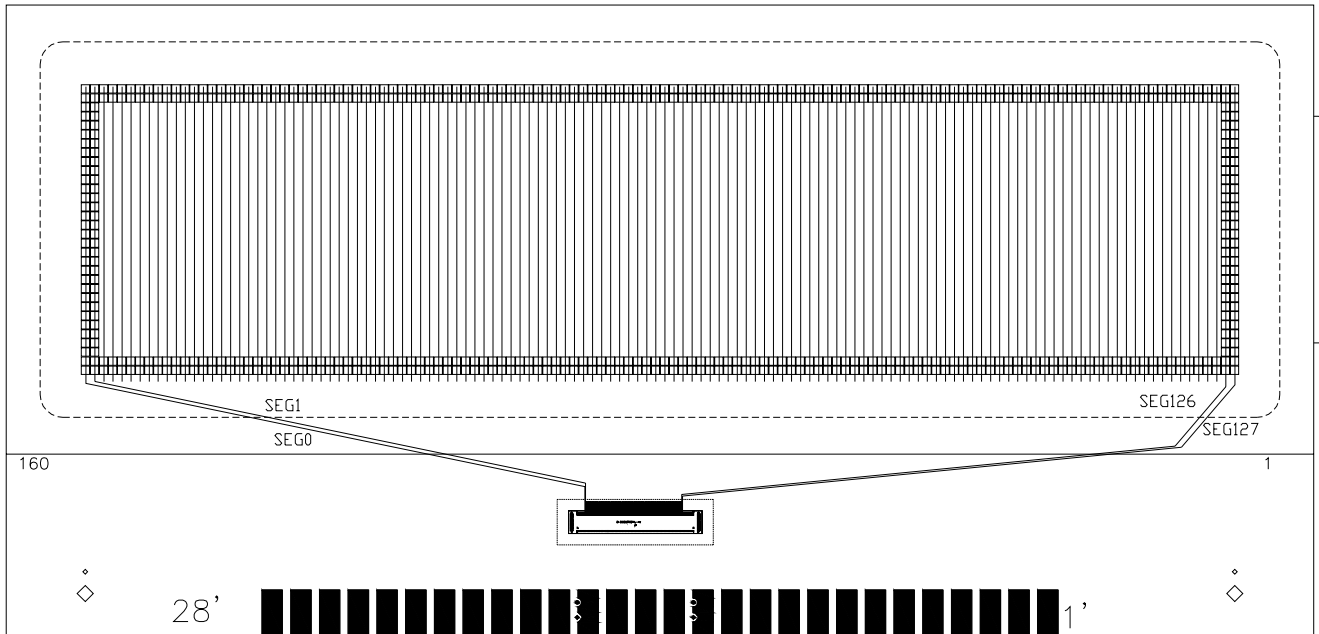

13. COM LAYOUT

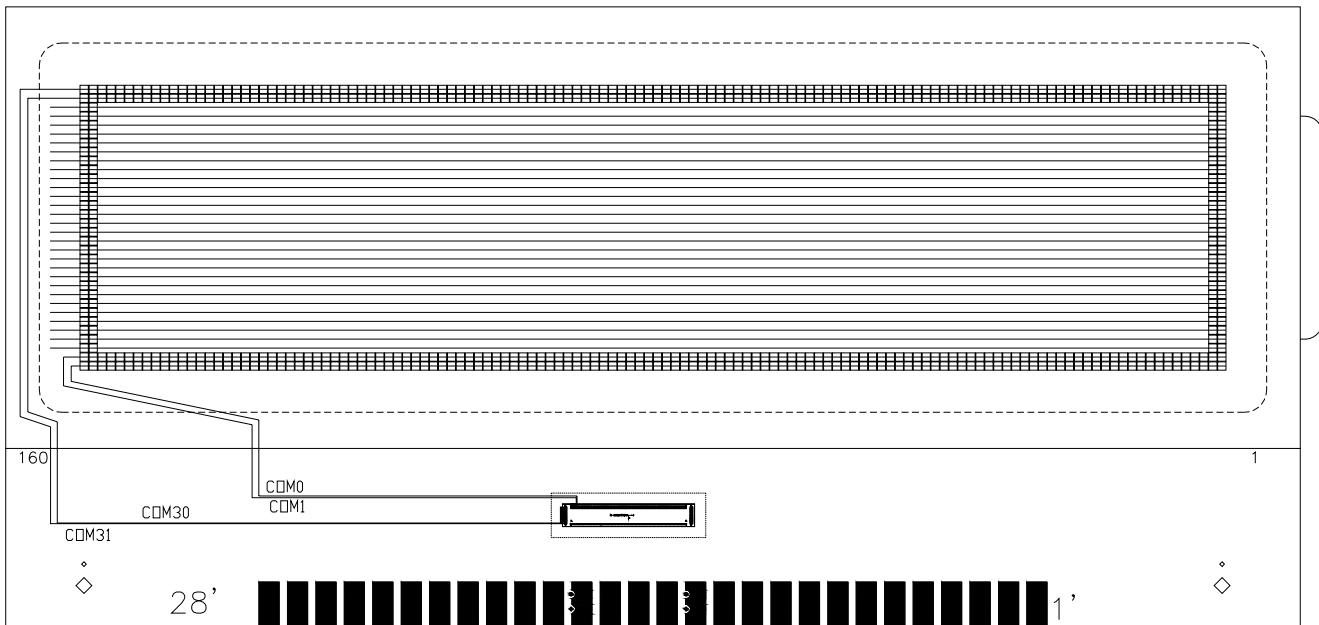

14. PAD CONFIGURATION GRAPHIC DIMENSION

IC NO.	PAD CONFIGURATION
COM31	COM31[R31<C0-C127>]
COM30	COM30[R30<C0-C127>]
COM1	COM1[R1<C0-C127>]
COM0	COM0[R0<C0-C127>]
SEG0	SEG0[C0<R0-R31>]
SEG1	SEG1[C1<R0-R31>]
SEG126	SEG126[C126<R0-R31>]
SEG127	SEG127[C127<R0-R31>]

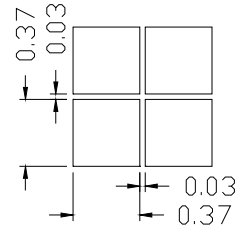

15. IC LAYOUT

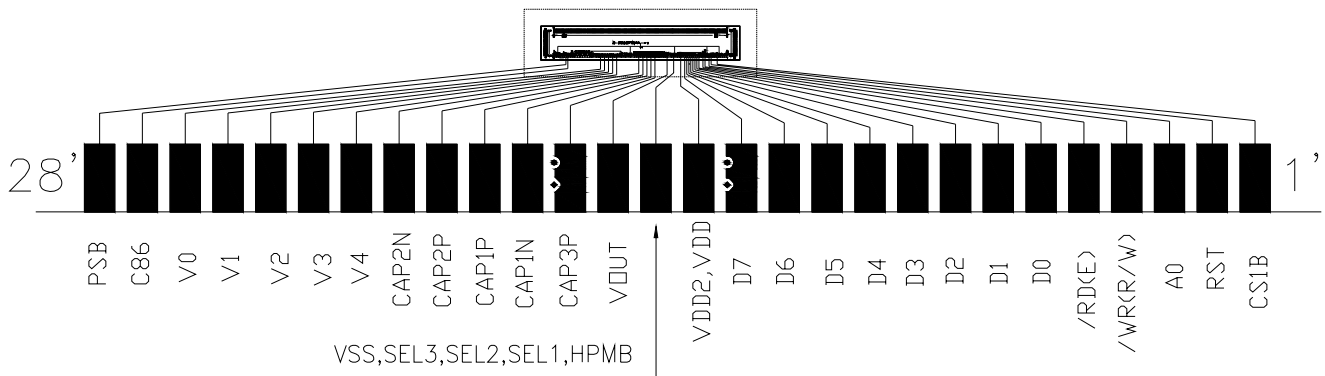

16. LCD MODULES HANDLING PRECAUTIONS

- The display panel is made of glass. Do not subject it to a mechanical shock by dropping it from a high place, etc.
- If the display panel is damaged and the liquid crystal substance inside it leaks out, do not get any in your mouth. If the substance come into contact with your skin or clothes promptly wash it off using soap and water.
- Do not apply excessive force to the display surface or the adjoining areas since this may cause the color tone to vary.
- The polarizer covering the display surface of the LCD module is soft and easily scratched. Handle this polarize carefully.
- To prevent destruction of the elements by static electricity, be careful to maintain an optimum work environment.
 - Be sure to ground the body when handling the LCD module.
 - Tools required for assembly, such as soldering irons, must be properly grounded.
 - To reduce the amount of static electricity generated, do not conduct assembly and other work under dry conditions.
 - The LCD module is coated with a film to protect the display surface. Exercise care when peeling off this protective film since static electricity may be generated.
- Storage precautions
When storing the LCD modules, avoid exposure to direct sunlight or to the light of fluorescent lamps. Keep the modules in bags designed to prevent static electricity charging under low temperature / normal humidity conditions (avoid high temperature / high humidity and low temperatures below -20°C). Whenever possible, the LCD modules should be stored in the same conditions in which they were shipped from our company.

17. OTHERS

- Liquid crystals solidify at low temperature (below the storage temperature range) leading to defective orientation of liquid crystal or the generation of air bubbles (black or white). Air bubbles may also be generated if the module is subjected to a strong shock at a low temperature.
- If the LCD modules have been operating for a long time showing the same display patterns may remain on the screen as ghost images and a slight contrast irregularity may also appear. Abnormal operating status can be resumed to be normal condition by suspending use for some time. It should be noted that this phenomena does not adversely affect performance reliability.
- To minimize the performance degradation of the LCD modules resulting from caused by static electricity, etc. exercise care to avoid holding the following sections when handling the modules:
 - Exposed area of the printed circuit board
 - Terminal electrode sections