

Features

- ✧ UL Recognized File # E-326243
- ✧ For surface mounted application in order to optimize board space
- ✧ Low profile package
- ✧ Built-in strain relief
- ✧ Glass passivated junction
- ✧ Excellent clamping capability
- ✧ Fast response time: Typically less than 1.0ps from 0 volt to BV min
- ✧ Typical I_R less than 1uA above 10V
- ✧ High temperature soldering guaranteed: 260°C / 10 seconds at terminals
- ✧ Plastic material used carries Underwriters Laboratory Flammability Classification 94V-0
- ✧ 1500 watts peak pulse power capability with a 10 / 1000 us waveform
- ✧ Green compound with suffix "G" on packing code & prefix "G" on datecode

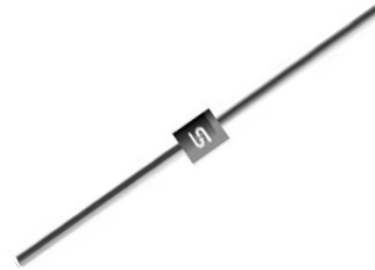

Mechanical Data

- ✧ Case: Molded plastic
- ✧ Lead: Pure tin plated lead free, solderable per MIL-STD-202, Method 208
- ✧ Polarity: Color band denotes cathode except bipolar
- ✧ Weight: 0.94 gram

Ordering Information (example)

Part No.	Package	Packing	INNER TAPE	Packing code	Green Compound Packing code
1.5KE6.8	DO-201	500 / AMMO box	52mm	A0	A0G

Maximum Ratings and Electrical Characteristics

Rating at 25°C ambient temperature unless otherwise specified

Single phase, half wave, 60Hz, resistive or inductive load.

For capacitive load, derate current by 20%

Type Number	Symbol	Value	Unit
Peak Power Dissipation at $T_A=25^\circ\text{C}$, $T_p=1\text{ms}$ (Note 1)	P_{PK}	Minimum 1500	Watts
Steady State Power Dissipation at $T_L=75^\circ\text{C}$ Lead Lengths .375", 9.5mm (Note 2)	P_D	5	Watts
Peak Forward Surge Current, 8.3ms Single Half Sine-wave Superimposed on Rated Load (JEDEC method)(Note 3)	I_{FSM}	200	Amps
Maximum Instantaneous Forward Voltage at 50 A for Unidirectional Only (Note 4)	V_F	3.5 / 5.0	Volts
Operating and Storage Temperature Range	T_J, T_{STG}	-55 to +175	°C

Note 1: Non-repetitive Current Pulse, Per Fig. 3 and Derated above $T_A=25^\circ\text{C}$ Per Fig. 2

Note 2: Mounted on Copper Pad Area of 0.6" x 0.6" (16mm x 16mm)

Note 3: 8.3ms Single Half Sine-wave or Equivalent Square Wave, Duty Cycle=4 Pulse Per Minute Maximum

Note 4: $V_F=3.5\text{V}$ for Devices of $V_{BR} \leq 200\text{V}$ and $V_F=5.0\text{V}$ Max. for Devices $V_{BR} > 200\text{V}$

Devices for Bipolar Applications

1. For Bidirectional Use C or CA Suffix for Types 1.5KE6.8 through Types 1.5KE440
2. Electrical Characteristics Apply in Both Directions

RATINGS AND CHARACTERISTIC CURVES (1.5KE SERIES)

FIG. 1 PEAK PULSE POWER RATING CURVE

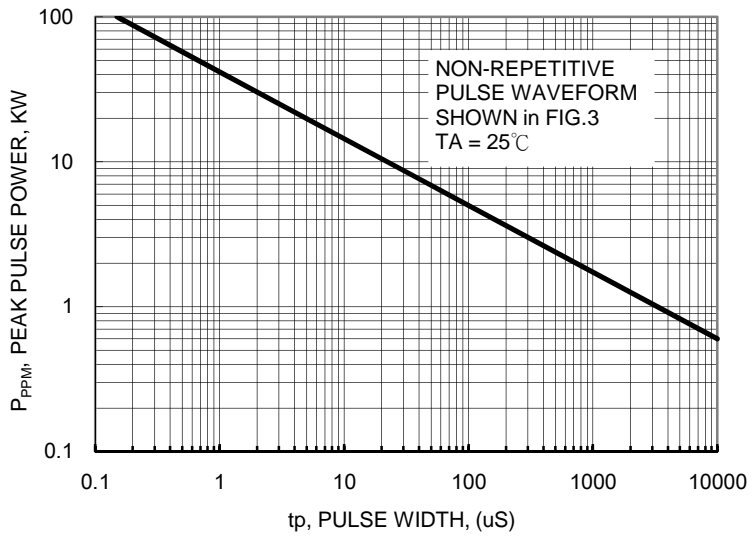

FIG.2 PULSE DERATING CURVE

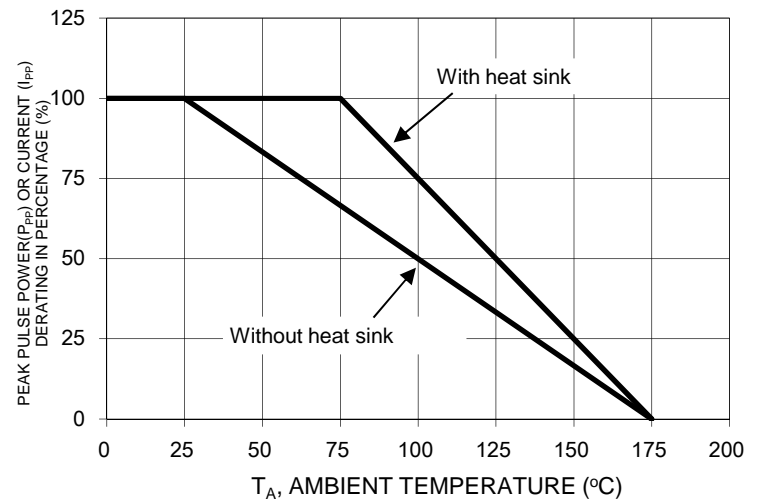

FIG. 3 CLAMPING POWER PULSE WAVEFORM

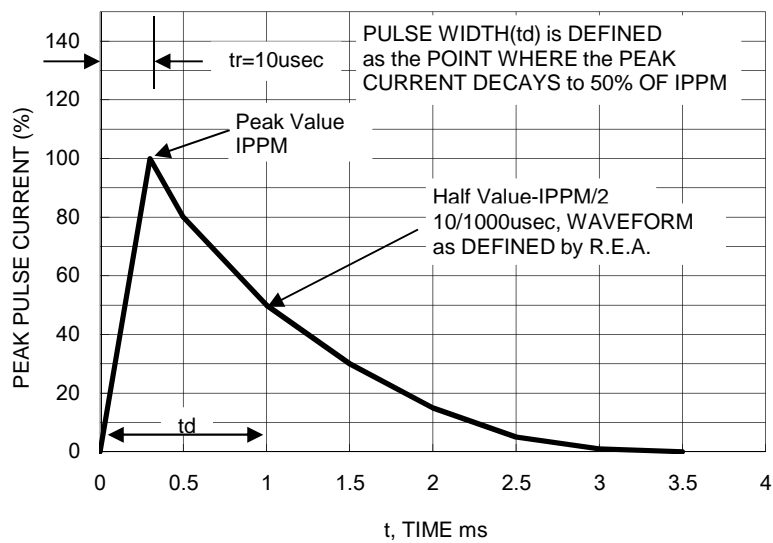

FIG. 4 MAXIMUM NON-REPETITIVE FORWARD SURGE CURRENT UNIDIRECTIONAL ONLY

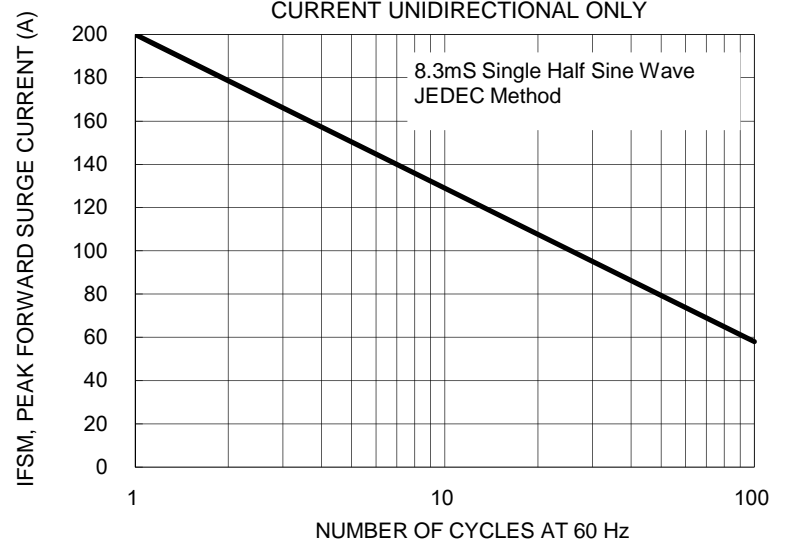
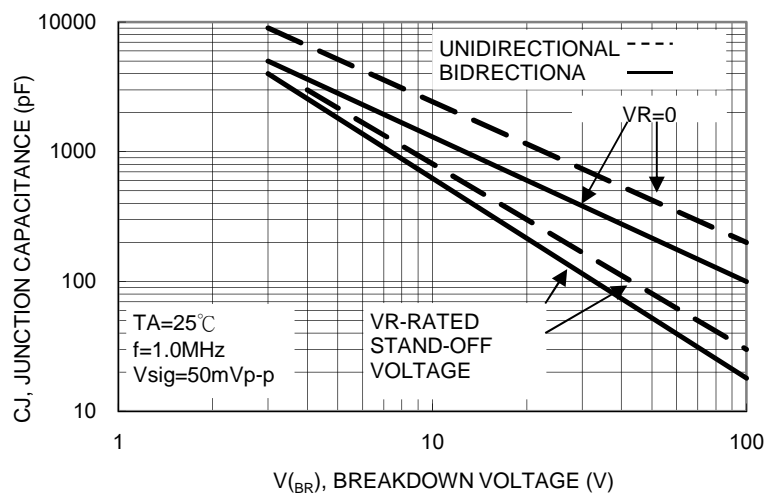

FIG. 5 TYPICAL JUNCTION CAPACITANCE



ELECTRICAL CHARACTERISTICS (TA=25°C unless otherwise noted)

JEDEC TYPE NUMBER	GENERAL PART NUMBER	Device Marking Code	Breakdown Voltage		Test Current I _T (mA)	Stand-Off Voltage V _{WM} (V)	Maximum Reverse Leakage @ V _{WM} ID (uA)	Maximum Peak Pulse Current I _{PPM} (A) (Note 2)	Maximum Clamping Voltage @ I _{PPM} Vc(V)	Maximum Temperature Coefficient of V _{BR} (%/°C)
			V _{BR} (V) (Note 1)							
			Min	Max						
1N6267	1.5KE6.8	6.8	6.12	7.48	10	5.50	1000	145	10.8	0.057
1N6267A	1.5KE6.8A	6.8	6.45	7.14	10	5.80	1000	150	10.5	0.057
1N6268	1.5KE7.5	7.5	6.75	8.25	10	6.05	500	134	11.7	0.061
1N6268A	1.5KE7.5A	7.5	7.13	7.88	10	6.40	500	139	11.3	0.061
1N6269	1.5KE8.2	8.2	7.38	9.02	10	6.63	200	126	12.5	0.065
1N6269A	1.5KE8.2A	8.2	7.79	8.61	10	7.02	200	130	12.1	0.065
1N6270	1.5KE9.1	9.1	8.19	10.00	1.0	7.37	50	114	13.8	0.068
1N6270A	1.5KE9.1A	9.1	8.65	9.55	1.0	7.78	50	117	13.4	0.068
1N6271	1.5KE10	10	9.00	11.00	1.0	8.10	10	105	15.0	0.073
1N6271A	1.5KE10A	10	9.50	10.5	1.0	8.55	10	108	14.5	0.073
1N6272	1.5KE11	11	9.90	12.1	1.0	8.92	1	97	16.2	0.075
1N6272A	1.5KE11A	11	10.5	11.6	1.0	9.40	1	100	15.6	0.075
1N6273	1.5KE12	12	10.8	13.2	1.0	9.72	1	91	17.3	0.078
1N6273A	1.5KE12A	12	11.4	12.6	1.0	10.2	1	94	16.7	0.078
1N6274	1.5KE13	13	11.7	14.3	1.0	10.5	1	82	19.0	0.081
1N6274A	1.5KE13A	13	12.4	13.7	1.0	11.1	1	86	18.2	0.081
1N6275	1.5KE15	15	13.5	16.5	1.0	12.1	1	71	22.0	0.084
1N6275A	1.5KE15A	15	14.3	15.8	1.0	12.8	1	74	21.2	0.084
1N6276	1.5KE16	16	14.4	17.6	1.0	12.9	1	67	23.5	0.086
1N6276A	1.5KE16A	16	15.2	16.8	1.0	13.6	1	70	22.5	0.086
1N6277	1.5KE18	18	16.2	19.8	1.0	14.5	1	59	26.5	0.088
1N6277A	1.5KE18A	18	17.1	18.9	1.0	15.3	1	60	25.5	0.088
1N6278	1.5KE20	20	18.0	22.0	1.0	16.2	1	54	29.1	0.090
1N6278A	1.5KE20A	20	19.0	21.0	1.0	17.1	1	56	27.7	0.090
1N6279	1.5KE22	22	19.8	24.2	1.0	17.8	1	49	31.9	0.092
1N6279A	1.5KE22A	22	20.9	23.1	1.0	18.8	1	51	30.6	0.092
1N6280	1.5KE24	24	21.6	26.4	1.0	19.4	1	45	34.7	0.094
1N6280A	1.5KE24A	24	22.8	25.2	1.0	20.5	1	47	33.2	0.094
1N6281	1.5KE27	27	24.3	29.7	1.0	21.8	1	40	39.1	0.096
1N6281A	1.5KE27A	27	25.7	28.4	1.0	23.1	1	42	37.5	0.096
1N6282	1.5KE30	30	27.0	33.0	1.0	24.3	1	36	43.5	0.097
1N6282A	1.5KE30A	30	28.5	31.5	1.0	25.6	1	38	41.4	0.097
1N6283	1.5KE33	33	29.7	36.3	1.0	26.8	1	33	47.7	0.098
1N6283A	1.5KE33A	33	31.4	34.7	1.0	28.2	1	34	45.7	0.098
1N6284	1.5KE36	36	32.4	39.6	1.0	29.1	1	30	52.0	0.099
1N6284A	1.5KE36A	36	34.2	37.8	1.0	30.8	1	31	49.9	0.099
1N6285	1.5KE39	39	35.1	42.9	1.0	31.6	1	27	56.4	0.100
1N6285A	1.5KE39A	39	37.1	41.0	1.0	33.3	1	29	53.9	0.100
1N6286	1.5KE43	43	38.7	47.3	1.0	34.8	1	25	61.9	0.101
1N6286A	1.5KE43A	43	40.9	45.2	1.0	36.8	1	26	59.3	0.101
1N6287	1.5KE47	47	42.3	51.7	1.0	38.1	1	23	67.8	0.101
1N6287A	1.5KE47A	47	44.7	49.4	1.0	40.2	1	24	64.8	0.101
1N6288	1.5KE51	51	45.9	56.1	1.0	41.3	1	21	73.5	0.102
1N6288A	1.5KE51A	51	48.5	53.6	1.0	43.6	1	22	70.1	0.102
1N6289	1.5KE56	56	50.4	61.6	1.0	45.4	1	19	80.5	0.103
1N6289A	1.5KE56A	56	53.2	58.8	1.0	47.8	1	20	77.0	0.103
1N6290	1.5KE62	62	55.8	68.2	1.0	50.2	1	17	89.0	0.104
1N6290A	1.5KE62A	62	58.9	65.1	1.0	53.0	1	18	85.0	0.104
1N6291	1.5KE68	68	61.2	74.8	1.0	55.1	1	16	98.0	0.104
1N6291A	1.5KE68A	68	64.6	71.4	1.0	58.1	1	17	92.0	0.104
1N6292	1.5KE75	75	67.5	82.5	1.0	60.7	1	14	108	0.105
1N6292A	1.5KE75A	75	71.3	78.8	1.0	64.1	1	15	103	0.105

ELECTRICAL CHARACTERISTICS (TA=25°C unless otherwise noted)

JEDEC TYPE NUMBER	GENERAL PART NUMBER	Device Marking Code	Breakdown Voltage V _{BR} (V) (Note 1)		Test Current I _T (mA)	Stand-Off Voltage V _{WM} (V)	Maximum Reverse Leakage @ V _{WM} ID (uA)	Maximum Peak Pulse Current I _{PPM} (A) (Note 2)	Maximum Clamping Voltage @ I _{PPM} V _c (V)	Maximum Temperature Coefficient of V _{BR} (%/°C)
			Min	Max						
1N6293	1.5KE82	82	73.8	90.2	1.0	66.4	1	13	118	0.105
1N6293A	1.5KE82A	82	77.9	86.1	1.0	70.1	1	13.9	113	0.105
1N6294	1.5KE91	91	81.9	100	1.0	73.7	1	12	131	0.106
1N6294A	1.5KE91A	91	86.5	95.5	1.0	77.8	1	12.6	125	0.106
1N6295	1.5KE100	100	90	110	1.0	81.0	1	10.9	144	0.106
1N6295A	1.5KE100A	100	95	105	1.0	85.5	1	11.4	137	0.106
1N6296	1.5KE110	110	99	121	1.0	89.2	1	9.9	158	0.107
1N6296A	1.5KE110A	110	105	116	1.0	94.0	1	10.3	152	0.107
1N6297	1.5KE120	120	108	132	1.0	97.2	1	9.1	173	0.107
1N6297A	1.5KE120A	120	114	126	1.0	102	1	9.5	165	0.107
1N6298	1.5KE130	130	117	143	1.0	105	1	8.4	187	0.107
1N6298A	1.5KE130A	130	124	137	1.0	111	1	8.7	179	0.107
1N6299	1.5KE150	150	135	165	1.0	121	1	7.3	215	0.108
1N6299A	1.5KE150A	150	143	158	1.0	128	1	7.6	207	0.108
1N6300	1.5KE160	160	144	176	1.0	130	1	6.8	230	0.108
1N6300A	1.5KE160A	160	152	168	1.0	136	1	7.1	219	0.108
1N6301	1.5KE170	170	153	187	1.0	138	1	6.4	244	0.108
1N6301A	1.5KE170A	170	162	179	1.0	145	1	6.7	234	0.108
1N6302	1.5KE180	180	162	198	1.0	146	1	6.1	258	0.108
1N6302A	1.5KE180A	180	171	189	1.0	154	1	6.4	246	0.108
1N6303	1.5KE200	200	180	220	1.0	162	1	5.4	287	0.108
1N6303A	1.5KE200A	200	190	210	1.0	171	1	5.7	274	0.108
	1.5KE220	220	198	242	1.0	175	1	4.5	344	0.110
	1.5KE220A	220	209	231	1.0	185	1	4.8	328	0.110
	1.5KE250	250	225	275	1.0	202	1	4.3	360	0.110
	1.5KE250A	250	237	263	1.0	214	1	4.5	344	0.110
	1.5KE300	300	270	330	1.0	243	1	3.6	430	0.110
	1.5KE300A	300	285	315.0	1.0	256	1	3.8	414	0.110
	1.5KE350	350	315	385	1.0	284	1	3.1	504	0.110
	1.5KE350A	350	333	368	1.0	300	1	3.2	482	0.110
	1.5KE400	400	360	440	1.0	324	1	2.7	574	0.110
	1.5KE400A	400	380	420	1.0	342	1	2.8	548	0.110
	1.5KE440	440	396	484	1.0	356	1	2.4	631	0.110
	1.5KE440A	440	418	462	1.0	376	1	2.5	602	0.110

Notes:

1. V_{BR} measure after I_T applied for 300us, I_T=square wave pulse or equivalent.
2. Surge current waveform per Figure. 3 and derate per Figure. 2.
3. For bipolar types having V_{WM} of 10 volts and under, the I_D limit is doubled.
4. All terms and symbols are consistent with ANSI/IEEE C62.35.

Ordering information

Part No.	Package	Packing	INNER TAPE	Packing code	Green Compound Packing code
1.5KExx (Note)	DO-201	1.25K / 13" Reel	52mm	R0	R0G
	DO-201	500 / Bulk packing		B0	B0G

Note: "xx" is Device Code from "6.8" thru "440".

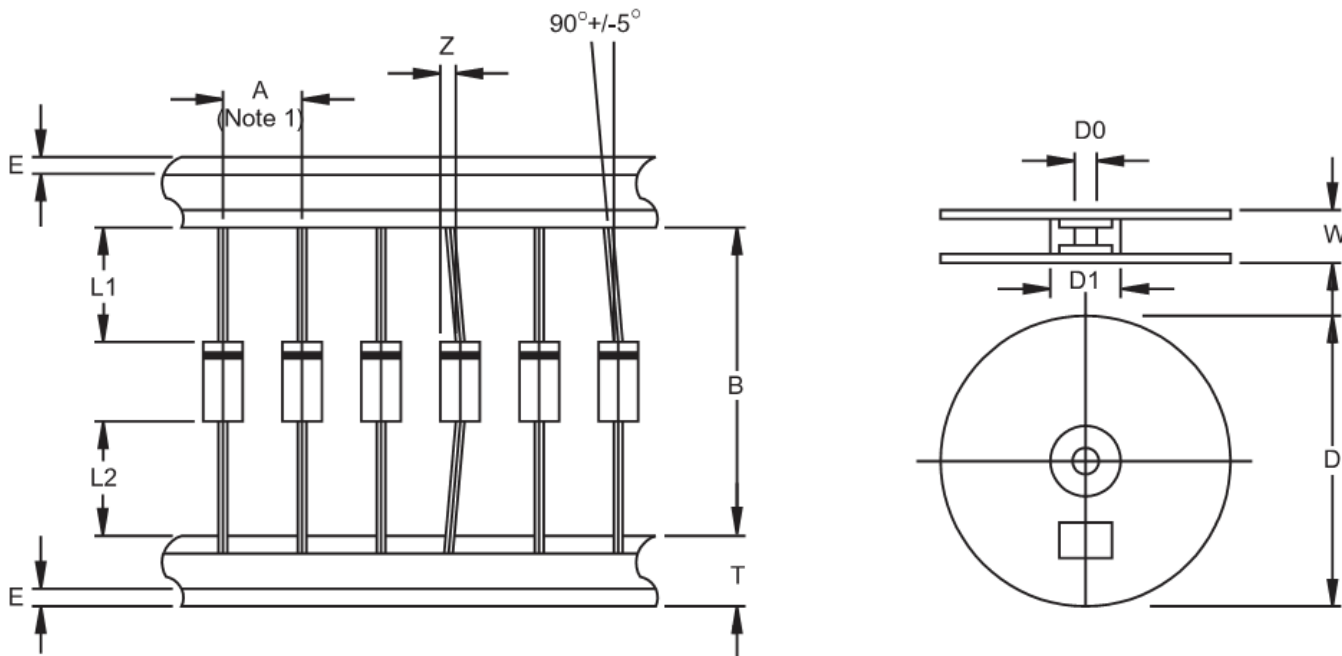
AXIAL LEAD TAPING SPECIFICATIONS

Outline	A	B	Z	T	E	L1-L2	D	D1	D0	W
		±0.5	±1.5	MAX	±0.4	MAX	MAX		±0.3	±0.4
DO-201	10	52.4	1.2	6	0.8	1	330	85.7	16.6	76

Unit (mm)

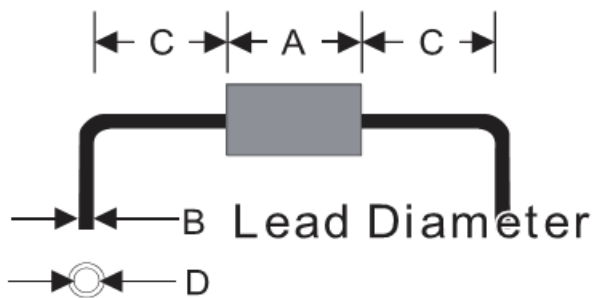
Suggested Mounting Hole Rule

Symbol	Unit(mm)
A	9.0
B	1.0
C	4.0
D	1.4

Dimensions

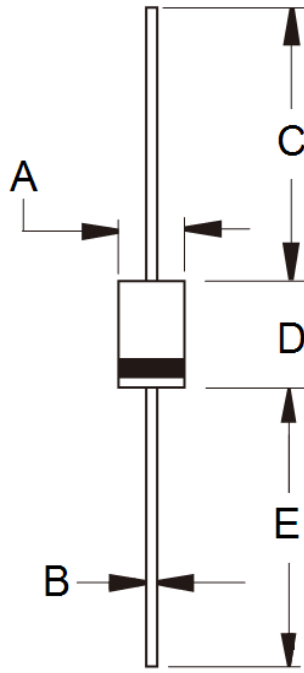

DIM.	Unit(mm)		Unit(inch)	
	Min	Max	Min	Max
A	5.00	5.60	0.197	0.220
B	0.96	1.06	0.038	0.042
C	25.40	-	1.000	-
D	8.50	9.50	0.335	0.375
E	25.40	-	1.000	-

Marking Diagram



- P/N = Specific Device Code
- G = Green Compound
- YWW = Date Code