

億力光電股份有限公司

EVERVISION ELECTRONICS CO., LTD.

Product Specification For LCD Module

(KVPF-7B-002-16)

Model NO. : VGG322433-6UFLWF(RoHS)

REVISION : 1

APPROVAL FOR SPECIFICATIONS ONLY

APPROVAL FOR SPECIFICATIONS AND SAMPLE

CUSTOMER :

STD.

APPROVED BY :

EVERVISION LCM R&D CENTER

APPROVED BY

CHECKED BY

PREPARED BY

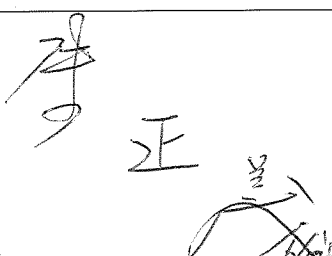

DIRECTOR

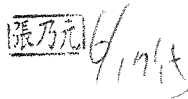

MANAGER

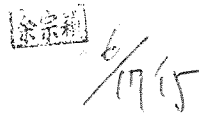

Mechanism Engineer

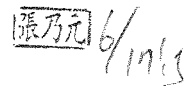

Electronic Engineer

億力光電股份有限公司總公司
EVERVISION ELECTRONICS LTD.

台北市中和區建一路 186 號 12 樓
12F., No.186, Jian 1st Rd., Zhonghe Dist., New
Taipei City 235, Taiwan (R.O.C.)
TEL : +886 2 8227-2788
FAX : +886 2 8227-2799

億力光電股份有限公司台中分公司
EVERVISION ELECTRONICS(T.C) LTD.

台中市潭子區建國路 19 號
No.19, Jianguo Rd., Tanzi Dist., Taichung City
427, Taiwan (R.O.C.)
TEL : +886 4 2532-8889
FAX : +886 4 2532-6689

東莞莞城德寶電子廠
EVERVISION ELECTRONICS(B.V.I) LTD.

廣東省東莞市城區東縱大道天寶路 9 號
NO.9, Tian Bao Rd., Dong Zong St., Dong Guan City
Guang Dong, China.
TEL : +86 769 2220 5258
FAX : +86 769 2220 7258

勁佳光電(昆山)有限公司
EVERVISION ELECTRONICS(KUNSHAN) LTD.

江蘇省昆山市玉山鎮高科技工業園城北路 8 號
NO.8, Chengbei Rd., Hi-Tech Industry Park,
Yushan Town, Kunshan City, Jiangsu, China.
TEL : +86 512 5778 7288
FAX : +86 512 5777 0688

<http://www.evervisionlcd.com>

EVERVISION	MODEL NO.		PAGE
	VGG322433-6UFLWF	SPEC ONLY	2

1. Table of Contents

No.	Contents	Page
1	Table of Contents	2
2	Record of Revisions	3
3	Module Numbering System	4
4	Application	5
5	Features	5
6	General Specifications	5
7	Absolute Maximum Ratings	6
8	Electrical Characteristics	7
9	Block Diagram	9
10	Input / Output Terminals Pin Assignment	10
11	Interface Timing	14
12	Optical Characteristics	23
13	Reliability Test	26
14	Packaging	27
15	Precautions	28
16	Outline Drawing	30
17	Definition of Labels	31
18	Incoming Inspection Standards	33

EVERVISION	MODEL NO.		PAGE
	VGG322433-6UFLWF	SPEC ONLY	4

3. Module Numbering System

V G G 3224 33 – 6 U F L W F

Serial No: A~Z

Backlight Color:

N:Without Backlight;
A:Amber; **B:**Blue; **G:**Green;
L:Yellow; **O:**Orange; **R:**Red;
W:White; **Y:**YellowGreen;
X:Others

Backlight Type:

N:Without Backlight; **E:**EL; **F:**CCFL;
L:General LED; **H:**High NTSC LED ;
R:RGB LED; **X:**Others

LCD Model:

A:ASTN; **B:**STN Blue; **C:**CSTN; **D:**DSTN;
F:TFT; **G:**STN Gray; **H:**HTN; **I:**IBN;
K:Black Mask TN **L:**LTPS; **M:**MVA;
N:others; **O:**OLED; **P:**PLED; **S:**IPS;
T:TN; **U:**FSC TN; **W:**FSTN Black/white;
X:FFSTN; **Y:**STN Yellow;

LCD Type:

R: Reflective/Positive;
S : Reflective/Negative ;
F : Transflective/Positive ;
G: Transflective/Negative ;
U: Transmissive/Positive ;
T: Transmissive/Negative ; **N:**Others

Temperature Range & View Direction:

General Purpose : **1:**6H **2:**12H **3:**3H **4:**9H **5:**Others
High Performance: **6:**6H **7:**12H **8:**3H **9:**9H **0:**Others

STD Product Serial No.: 01~99

Customer Made Serial No.: A1,A2...A9,B1,B2...B9,C1..

Display Function:

Segment Number / Characters Lines / Column and Row Dots
/ Length * Width of Other

Display Type:

C:Character Type; **G:**Graphic Type; **S:**Segment Type; **O:**Other

Package Type:

B:COB; **F:**COF; **G:**COG; **H:**Heat Seal; **S:**SMT; **T:**TAB; **O:**Others

EVERVISION	MODEL NO.		PAGE
	VGG322433-6UFLWF	SPEC ONLY	5

4. Application

This specification is applied to the 3.5 inch QVGA supported TFT-LCD module, and can display 16M colors. The module is designed for PMP, GPS, DMB, other electronic products which require flat panel display of digital signal interface, and used as the input devices for general electric appliances via both finger and Capacitive stylus pen.

5. Features

- QVGA (320×240 pixels) resolution.
- Display in 16M colors
- Line inversion mode with stripe type.
- On-chip voltage generator
- SYNC mode is supported for digital RGB input data format.
- This display has extended temperature range.
- Projected Capacitive Touch
 - I²C Interface
 - Multi Touch (Ten points)

6. General Specifications

Item	Specifications	Unit
Screen Size	3.5 (Diagonal)	inch
Display Format	320RGB(H)×240(V)	dot
Active Area	70.08(H)×52.56(V)	mm
Dot Pitch	0.073(H)×0.219(V)	mm
Pixel Configuration	RGB Vertical Stripe	-
Display Mode	TN Type Transmissive Mode(Micro Reflective) Normally White	-
Surface Treatment	Clear(7H)	-
Viewing Direction	6 O'clock (The Gray Inversion will appear at this direction)	-
Outline Dimension	76.9(W)×63.9(H)×4.85(D)	mm
DC to DC circuit	Build-in	-
Weight	46.7	g
RoHS Compliance	Evervision certifies this product to be in compliance with European Union Directive 2011/65/EU on the restriction of certain hazardous substances in electrical and electronic equipment.	-

EVERVISION	MODEL NO.		PAGE
	VGG322433-6UFLWF	SPEC ONLY	6

7. Absolute Maximum Ratings

7.1 Absolute Ratings of Environment

Item	Symbol	Value		Unit	Note
		Min.	Max.		
Storage Temperature	T _{ST}	-40	+80	°C	(1)(2)
Operating Temperature	T _{OP}	-30	+80	°C	(1)(2)

Note1: Background color changes slightly depending on ambient temperature.

This phenomenon is reversible.

Note2: Please refer to item of RELIABILITY.

7.2 Electrical Absolute Ratings

7.2.1 TFT-LCD Module

(Ta=25±2°C, GND=V_{SS}=0V)

Item	Symbol	Value		Unit	Note
		Min.	Max.		
Digital Power Supply Voltage	V _{CC}	V _{SS} -0.3	5.0	V	-

7.2.2 Backlight Unit

(Ta=25±2°C)

Item	Symbol	Value		Unit	Note
		Min.	Max.		
Forward current	I _f	-	(50)	mA	(1)
Reverse voltage	V _R	-	(25)	V	(1)

Note (1) Permanent damage to the device may occur if maximum values are exceeded or reverse voltage is loaded.

8. Electrical Characteristics

8.1 TFT-LCD Module

(Ta=25±2°C)

Item	Symbol	Value			Unit	Note
		Min.	Typ.	Max.		
Power Supply Voltage	V _{CC}	2.5	3.3	3.6	V	-
Power Supply Current	I _{CC}	-	15.6	22.0	mA	(1)
Input High Threshold Voltage	V _{IH}	0.8V _{CC}	-	V _{CC}	V	-
Input Low Threshold Voltage	V _{IL}	0	-	0.2V _{CC}	V	-
Power Consumption	P _L	-	51.48	72.6	mW	(1)
VSYNC Frequency	F _V	-	60	90	Hz	-
HSYNC Frequency	F _H	-	15.72	22.35	KHz	-
DCLK Frequency	DCLK	-	6.5	10	MHz	-

Note (1) The specified power consumption is under the conditions at V_{CC}=3.3V, F_V=60Hz, whereas a power dissipation check pattern below is displayed.

Black Pattern / 0 Gray

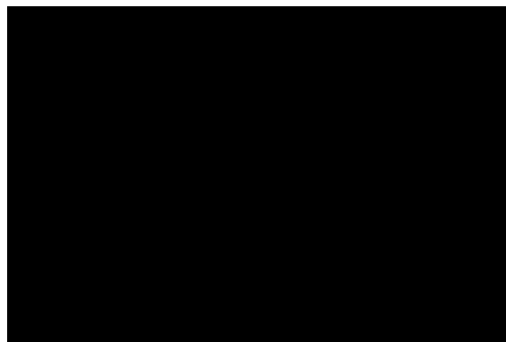

Active Area

8.2 Backlight Unit

(Ta=25±2°C)

Item	Symbol	Value			Unit	Note
		Min.	Typ.	Max.		
LED Voltage	VL	-	(16.5)	-	V	(1)
LED Current	IL	-	(40)	-	mA	(1)
Power Consumption	P _{BL}	-	(660)	-	mW	(1)
LED Life Time(25°C)	-	50000	60000	-	hr	(2)

Note (1) The driving design of backlight unit is dependent on serial consideration of 5S2P LEDs.

Note (2) LED life time is defined as under 25±2°C, when the average brightness decrease to 50% of original brightness

8.3 Projected Capacitive Touch

Item	Symbol	Value			Unit	Note
		Min.	Typ.	Max.		
Operating Voltage	VDD	3.0	3.3	3.6	V	-
Power Supply Current	IDD	-	9.4	13.2	mA	(1)
Input High Threshold Voltage	V _{IH}	0.7VDD	-	VDD	V	-
Input Low Threshold Voltage	V _{IL}	-0.3	-	0.3VDD	V	-
Output High Threshold Voltage	V _{OH}	0.7VDD	-	-	V	-
Output Low Threshold Voltage	V _{OL}	-	-	0.3VDD	V	-
Power Consumption	P _L	-	31.02	43.56	mW	@3.3V
Interface		I ² C				-
Function		Multi Touch				-

Note (1) This test condition is touched with 10 points.

9. Block Diagram
TFT-LCD Module with Backlight Unit

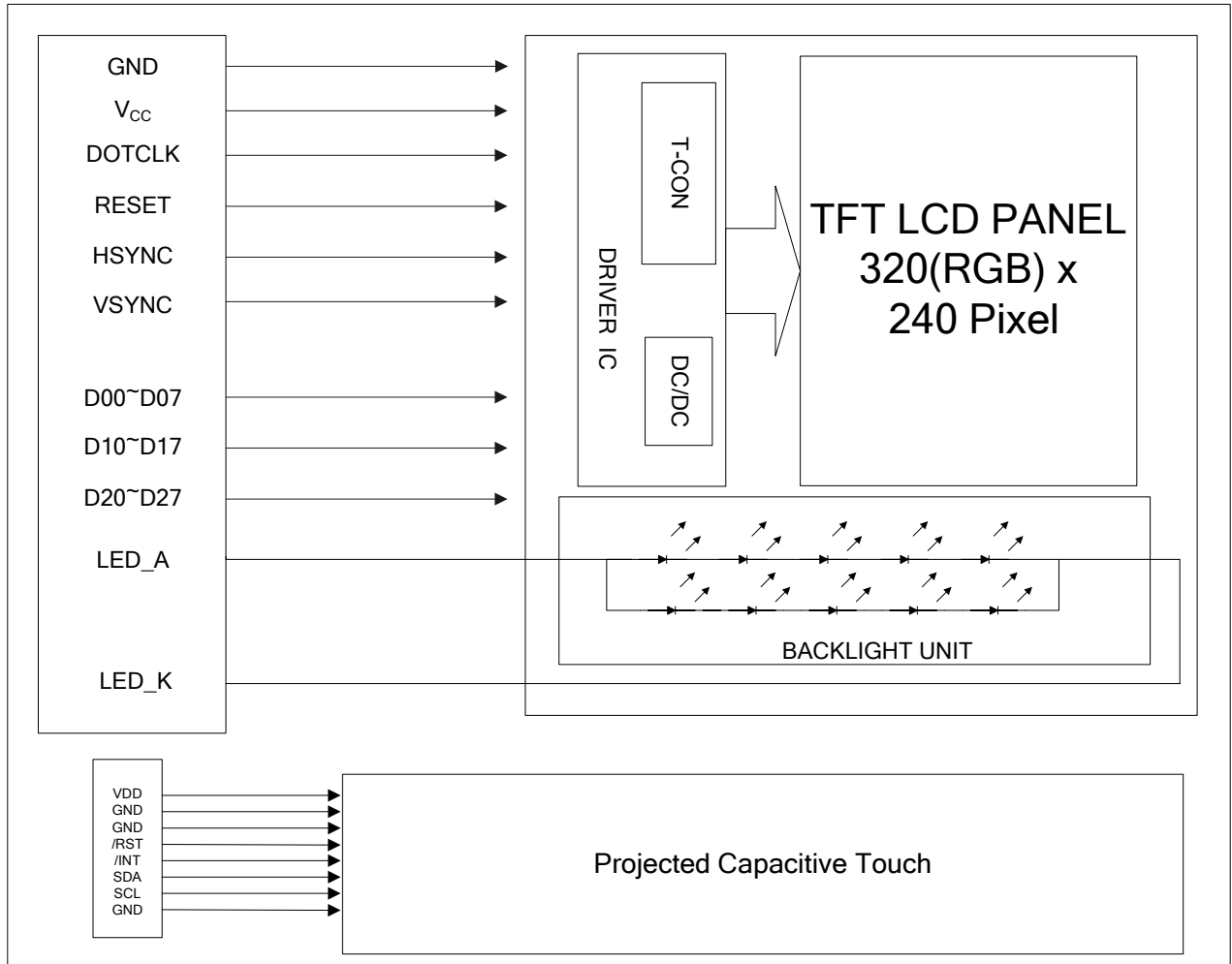

10. Input / Output Terminals Pin Assignment

10.1 TFT-LCD Module (CVILUX CF25541D0R0-05)

Pin No.	Symbol	I/O	Description
1	LED_K	I	LED_cathode
2	LED_K	I	LED_cathode
3	LED_A	I	LED_anode
4	LED_A	I	LED_anode
5	NC	I	No connection
6	NC	I	No connection
7	NC	I	No connection
8	RESET	I	Reset
9	NC	I	No connection
10	NC	I	No connection
11	NC	I	No connection
12	D20	I	Blue data(LSB)
13	D21	I	Blue data
14	D22	I	Blue data
15	D23	I	Blue data
16	D24	I	Blue data
17	D25	I	Blue data
18	D26	I	Blue data
19	D27	I	Blue data(MSB)
20	D10	I	Green data(LSB)
21	D11	I	Green data
22	D12	I	Green data
23	D13	I	Green data
24	D14	I	Green data
25	D15	I	Green data
26	D16	I	Green data
27	D17	I	Green data(MSB)
28	D00	I	Red data(LSB)
29	D01	I	Red data
30	D02	I	Red data

Pin No.	Symbol	I/O	Description
31	D03	I	Red data
32	D04	I	Red data
33	D05	I	Red data
34	D06	I	Red data
35	D07	I	Red data(MSB)
36	HSYNC	I	Line synchronization signal.
37	VSYNC	I	Frame synchronization signal.
38	DOTCLK	I	Dot Colck signal
39	NC	I	No connection
40	NC	I	No connection
41	V _{CC}	I	For system power supply.
42	V _{CC}	I	For system power supply.
43	NC	I	No connection
44	NC	I	No connection
45	NC	I	No connection
46	NC	I	No connection
47	NC	I	No connection
48	NC	I	No connection
49	NC	I	No connection
50	NC	I	No connection
51	NC	I	No connection
52	NC	I	No connection
53	GND	I	Ground
54	GND	I	Ground

10.2 Projected Capacitive Touch

Connector : CVILUX CF25081D0R0-05

Pin No.	Symbol	I/O	Description
1	VDD	I	+3.3V power supply.
2	GND	I	System ground.
3	GND	I	System ground.
4	/RST	I	External reset signal, active low.
5	/INT	O	Interrupt signal, active low, asserted to request Host start a new transaction.
6	SCL	I	I ² C clock signal.
7	GND	I	System ground.
8	SDA	I/O	I ² C data signal.

EVERVISION	MODEL NO.		PAGE
	VGG322433-6UFLWF	SPEC ONLY	14

11. Interface Timing

11.1 Input Signal Characteristics

11.1.1 Digital Parallel RGB Interface (960×240 resolution)

Characteristics	Symbol	Min.	Typ.	Max.	Unit
		24 bit	24 bit	24 bit	
DOTCLK Frequency	fDOTCLK	-	6.5	10	MHz
DOTCLK Period	tDOTCLK	100	154	-	ns
Horizontal Frequency (Line)	fH	-	14.9	22.35	KHz
Vertical Frequency (Refresh)	fV	-	60	90	Hz
Horizontal Back Porch	tHBP	-	68	-	tDOTCLK
Horizontal Front Porch	tHFP	-	20	-	tDOTCLK
Horizontal Data Start Point	tHBP	-	68	-	tDOTCLK
Horizontal Blanking Period	tHBP + tHFP	-	88	-	tDOTCLK
Horizontal Display Area	HDISP	-	320	-	tDOTCLK
Horizontal Cycle	Hcycle	-	408	450	tDOTCLK
Vertical Back Porch	tVBP	-	18	-	Lines
Vertical Front Porch	tVFP	-	4	-	Lines
Vertical Data Start Point	tVBP	-	18	-	Lines
Vertical Blanking Period	tVBP + tVFP	-	22	-	Lines
Vertical Display Area	NTSC	VDISP	240	-	Lines
	PAL		280(PALM=0)		
			288(PALM=1)		
Vertical Cycle	NTSC	Vcycle	262	350	Lines
	PAL		313		

11.2 Waveform

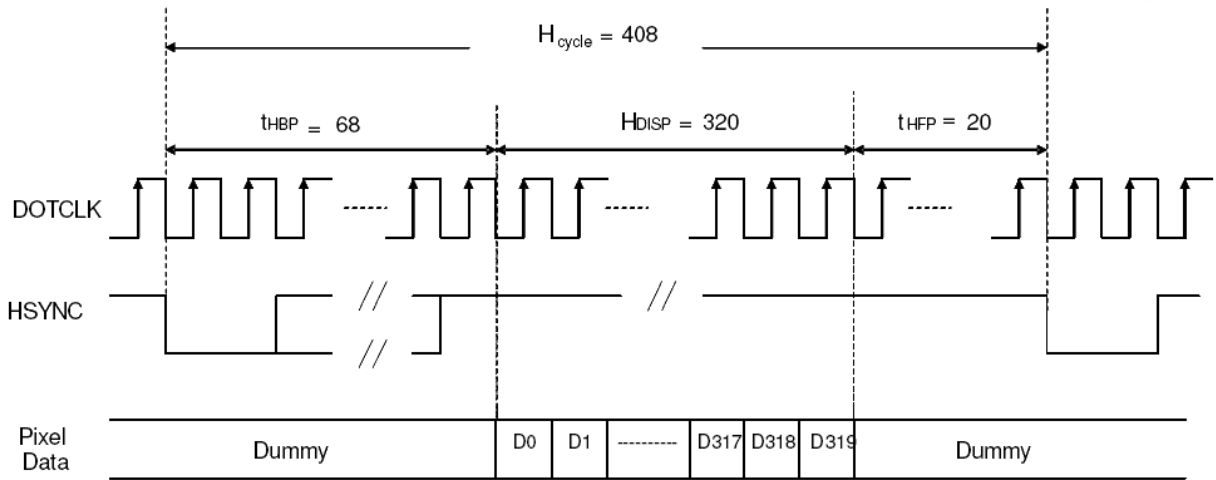

Horizontal Data Transaction Timing

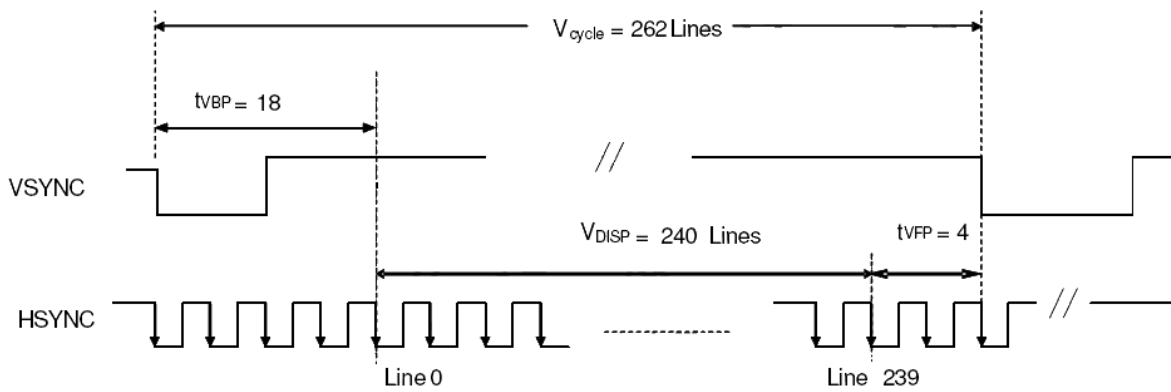

Vertical Data Transaction Timing

Data Transaction Timing in Parallel RGB (24 bit) Interface (SYNC Mode)

11.3 Power On / Off Sequence

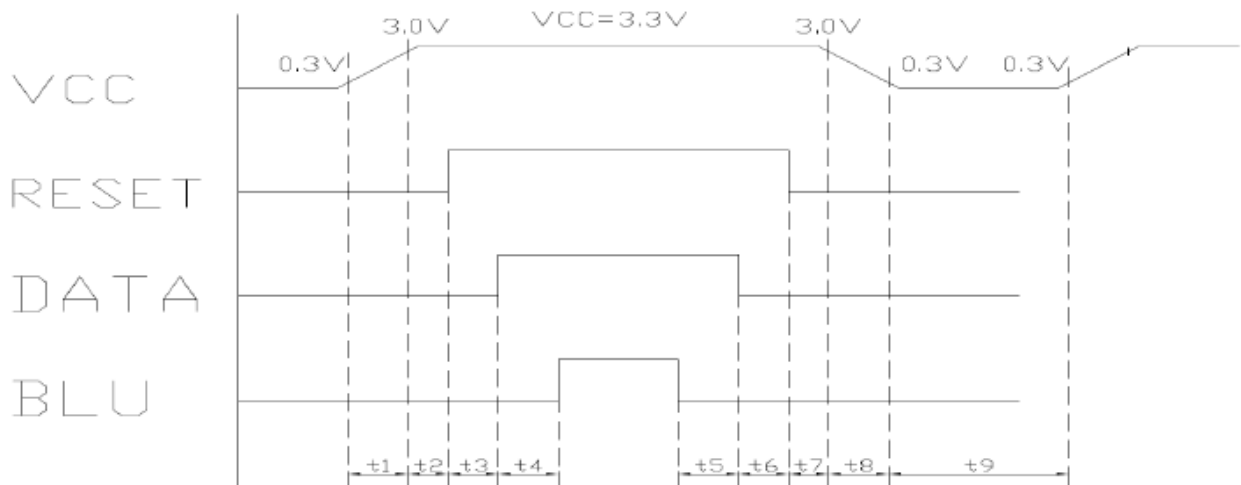

- | | | |
|-------------------|-------------------|-------------------------|
| $T1 \leq 10ms$ | $200ms \leq T5$ | $1 \text{ sec} \leq T9$ |
| $10\mu s \leq T2$ | $50ms \leq T6$ | |
| $50ms \leq T3$ | $10\mu s \leq T7$ | |
| $200ms \leq T4$ | $T8 \leq 10ms$ | |

11.4 Timing Requirement of Projected Capacitive Touch

11.4.1 I2C Data Transfer Format

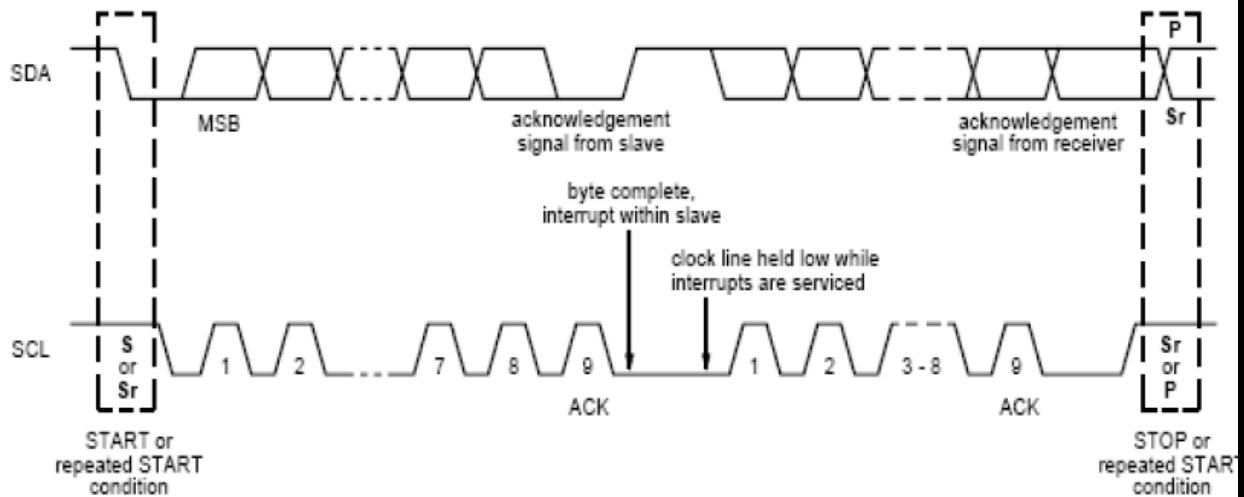

Mnemonics	Description
S	I ² C Start or I ² C Restart
A[6:0]	Slave Address = 7'b0111000
W	1'b0: Write
R	1'b1: Read
C	ACK
P	STOP: the indicate the end of a packet (if this bit is missing, S will indicate the end of the current packet and the beginning of the next packet)

Write N bytes to I2C slave

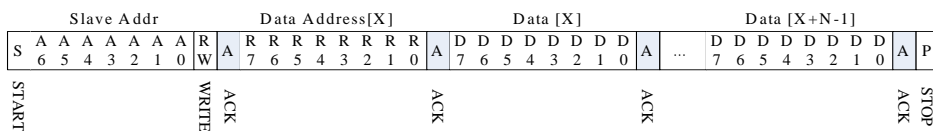

Set Data Address

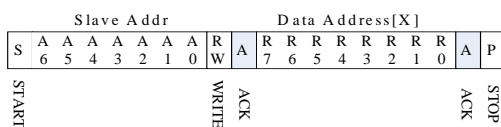

Read X bytes from I2C Slave

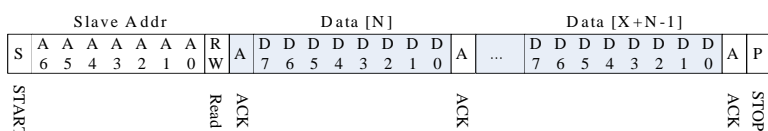

EVERVISION	MODEL NO.		PAGE
	VGG322433-6UFLWF	SPEC ONLY	18

11.4.2 I2C Timing Characteristics

(Ta=25±2°C)

Parameter	Min	Max	Unit
SCL frequency	-	400	kHz
Bus free time between a STOP and START condition	4.7	-	μs
Hold time (repeated) START condition	4.0	-	μs
Data setup time	250	-	ns
Setup time for a repeated START condition	4.7	-	μs
Setup time for STOP condition	4.0	-	μs

11.4.3 Interrupt Trigger Mode

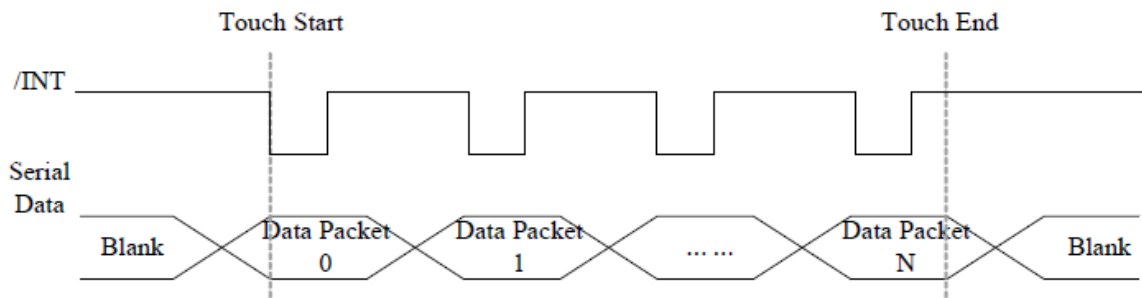

11.4.4 I2C Operating Mode Register Map

Address	Name	Bit 7	Bit 6	Bit 5	Bit 4	Bit 3	Bit 2	Bit 1	Bit 0	Host Access
Op,00h	DEVICE_MODE	Device Mode[2:0]								RW
Op,01h	Reserved									R
Op,02h	TD_STATUS						Number of touch points[3:0]			R
Op,03h	TOUCH1_YH	1 st Event Flag					1 st Touch Y Position[11:8]			R
Op,04h	TOUCH1_YL	1 st Touch Y Position[7:0]								R
Op,05h	TOUCH1_XH	1 st Touch ID[3:0]				1 st Touch X Position[11:8]				R
Op,06h	TOUCH1_XL	1 st Touch X Position[7:0]								R
Op,07h	Reserved									R
Op,08h	Reserved									R

EVERVISION	MODEL NO.		PAGE
	VGG322433-6UFLWF	SPEC ONLY	19

Op,09h	TOUCH2_YH	2 nd Event Flag		2 nd Touch Y Position[11:8]	R
Op,0Ah	TOUCH2_YL	2 nd touch Y Position[7:0]			R
Op,0Bh	TOUCH2_XH	2 nd Touch ID[3:0]		2 nd Touch X Position[11:8]	R
Op,0Ch	TOUCH2_XL	2 nd Touch X Position[7:0]			R
Op,0Dh	Reserved				R
Op,0Eh	Reserved				R
Op,0Fh	TOUCH3_YH	3 rd Event Flag		3 rd Touch Y Position[11:8]	R
Op,10h	TOUCH3_YL	3 rd Touch Y Position[7:0]			R
Op,11h	TOUCH3_XH	3 rd Touch ID[3:0]		3 rd Touch X Position[11:8]	R
Op,12h	TOUCH3_XL	3 rd Touch X Position[7:0]			R
Op,13h	Reserved				R
Op,14h	Reserved				R
Op,15h	TOUCH4_YH	4 th Event Flag		4 th Touch Y Position[11:8]	R
Op,16h	TOUCH4_YL	4 th Touch Y Position[7:0]			R
Op,17h	TOUCH4_XH	4 th Touch ID[3:0]		4 th Touch X Position[11:8]	R
Op,18h	TOUCH4_XL	4 th Touch X Position[7:0]			R
Op,19h	Reserved				R
Op,1Ah	Reserved				R
Op,1Bh	TOUCH5_YH	5 th Event Flag		5 th Touch Y Position[11:8]	R
Op,1Ch	TOUCH5_YL	5 th Touch Y Position[7:0]			R
Op,1Dh	TOUCH5_XH	5 th Touch ID[3:0]		5 th Touch X Position[11:8]	R
Op,1Eh	TOUCH5_XL	5 th Touch X Position[7:0]			R
Op,1Fh	Reserved				R
Op,20h	Reserved				R
Op,21h	TOUCH6_YH	6 th Event Flag		6 th Touch Y Position[11:8]	R
Op,22h	TOUCH6_YL	6 th Touch Y Position[7:0]			R
Op,23h	TOUCH6_XH	6 th Touch ID[3:0]		6 th Touch X Position[11:8]	R
Op,24h	TOUCH6_XL	6 th Touch X Position[7:0]			R

EVERVISION	MODEL NO.		PAGE
	VGG322433-6UFLWF	SPEC ONLY	20

Op,25h	Reserved			R	
Op,26h	Reserved			R	
Op,27h	TOUCH7_YH	7 th Event Flag		7 th Touch Y Position[11:8]	R
Op,28h	TOUCH7_YL	7 th Touch Y Position[7:0]		R	
Op,29h	TOUCH7_XH	7 th Touch ID[3:0]		7 th Touch X Position[11:8]	R
Op,2Ah	TOUCH7_XL	7 th Touch X Position[7:0]		R	
Op,2Bh	Reserved			R	
Op,2Ch	Reserved			R	
Op,2Dh	TOUCH8_YH	8 th Event Flag		8 th Touch Y Position[11:8]	R
Op,2Eh	TOUCH8_YL	8 th Touch Y Position[7:0]		R	
Op,2Fh	TOUCH8_XH	8 th Touch ID[3:0]		8 th Touch X Position[11:8]	R
Op,30h	TOUCH8_XL	8 th Touch X Position[7:0]		R	
Op,31h	Reserved			R	
Op,32h	Reserved			R	
Op,33h	TOUCH9_YH	9 th Event Flag		9 th Touch Y Position[11:8]	R
Op,34h	TOUCH9_YL	9 th Touch Y Position[7:0]		R	
Op,35h	TOUCH9_XH	9 th Touch ID[3:0]		9 th Touch X Position[11:8]	R
Op,36h	TOUCH9_XL	9 th Touch X Position[7:0]		R	
Op,37h	Reserved			R	
Op,38h	Reserved			R	
Op,39h	TOUCH10_YH	10 th Event Flag		10 th Touch Y Position[11:8]	R
Op,3Ah	TOUCH10_YL	10 th Touch Y Position[7:0]		R	
Op,3Bh	TOUCH10_XH	10 th Touch ID[3:0]		10 th Touch X Position[11:8]	R
Op,3Ch	TOUCH10_XL	10 th Touch X Position[7:0]		R	
Op,3Dh	Reserved			R	
Op,3Eh	Reserved			R	

11.4.5 DEVICE_MODE

This register is the device mode register, configure it to determine the current mode of the chip.

Address	Bit Address	Register Name	Description
Op,00h	6:4	Device Mode [2:0]	000b Normal operating Mode 001b System Information Mode (Reserved) 100b Test Mode – read raw data (Reserved)

11.4.6 TD_STATUS

This register is the Touch Data status register.

Address	Bit Address	Register Name	Description
Op,02h	3:0	Number of touch points[3:0]	How many points detected. 1-10 is valid.

11.4.7 TOUCHn_YH (n:1-10)

This register describes MSB of the Y coordinate of the nth touch point and the corresponding event flag.

Address	Bit Address	Register Name	Description
Op,03h ~ Op,39h	7:6	Event Flag	00b: Put Down 01b: Put Up 10b: Contact 11b: No event
	5:4		Reserved
	3:0	Touch Y Position [11:8]	MSB of Touch Y Position in pixels

11.4.8 TOUCHn_YL (n:1-10)

This register describes LSB of the Y coordinate of the nth touch point.

Address	Bit Address	Register Name	Description
Op,04h ~ Op,3Ah	7:0	Touch Y Position [7:0]	LSB of the Touch Y Position in pixels

11.4.9 TOUCHn_XH (n:1-10)

This register describes MSB of the X coordinate of the nth touch point and corresponding touch ID.

Address	Bit Address	Register Name	Description
Op,05h ~ Op,3Bh	7:4 3:0	Touch ID[3:0] Touch X Position [11:8]	Touch ID of Touch Point MSB of Touch X Position in pixels

11.4.10 TOUCHn_XL (n:1-10)

This register describes LSB of the X coordinate of the nth touch point.

Address	Bit Address	Register Name	Description
Op,06h ~ Op,3Ch	7:0	Touch X Position [7:0]	LSB of The Touch X Position in pixels

12. Optical Characteristics

The optical characteristics should be measured in a dark environment (≤ 1 lux) or equivalent state with the methods shown in Note (4).

Item		Symbol	Conditions	Min.	Typ.	Max.	Unit	Note
Contrast Ratio		CR	$\theta_x=0^\circ, \theta_y=0^\circ$ Viewing Normal Angle	400	(500)	-	-	(2)
Response Time		T_{R+T_F}		-	50	-	ms	(3)
Luminance(Center)		Y		880	(1060)	-	cd/m ²	(4)
Brightness uniformity		B _{UNI}		75	(80)	-	%	(5)
Color Chromaticity	Red	R _x		0.595	0.645	0.695	-	(1),(4)
		R _y		0.295	0.345	0.395	-	
	Green	G _x		0.315	0.365	0.415	-	
		G _y		0.520	0.570	0.620	-	
	Blue	B _x		0.095	0.145	0.195	-	
		B _y		0.045	0.095	0.145	-	
	White	W _x	0.250	0.300	0.350	-		
		W _y	0.260	0.310	0.360	-		
Viewing Angle	Horizontal	θ_{x+}	CR \geq 10	55	(70)	-	deg.	
		θ_{x-}		55	(70)	-		
	Vertical	θ_{y+}		40	(55)	-		
		θ_{y-}		50	(70)	-		

Note (1) Definition of Viewing Angle (θ_x, θ_y):

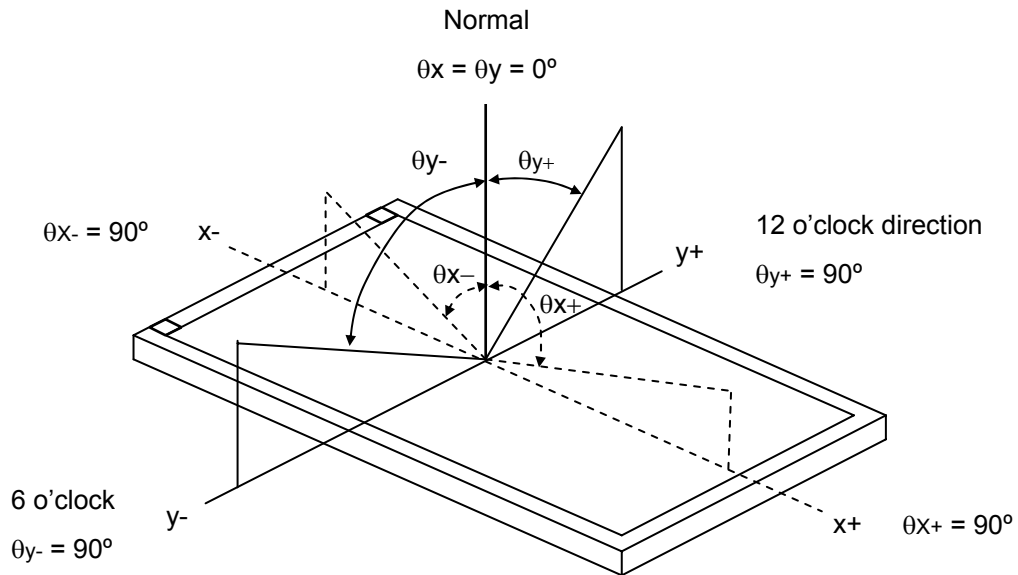

Note (2) Definition of Contrast Ratio (CR):

$$\text{Contrast ratio (CR)} = \frac{\text{Luminance measured when LCD on the "White" state}}{\text{Luminance measured when LCD on the "Black" state}}$$

Note (3) Definition of Response Time (T_R, T_F):

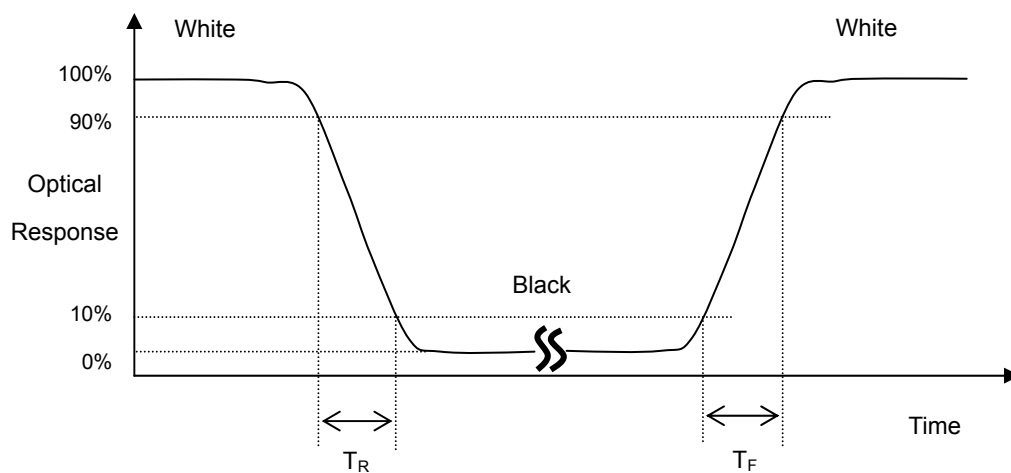

Note (4) Measurement Set-Up:

The LCD module should be stabilized at a given temperature for 30 minutes to avoid abrupt temperature change during measuring. In order to stabilize the luminance, the measurement should be executed after lighting Backlight for 30 minutes in a dark room or equivalent condition.

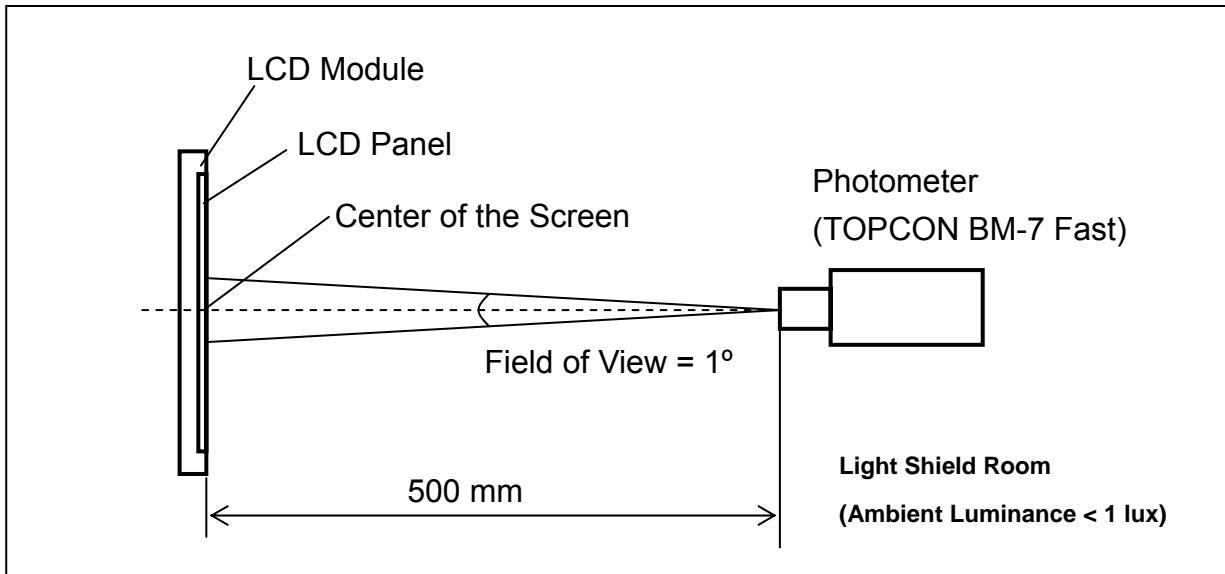

Note (5) Definition of brightness uniformity

$$\text{Brightness uniformity} = (\text{Min Luminance of 9 points}) / (\text{Max Luminance of 9 points}) \times 100\%$$

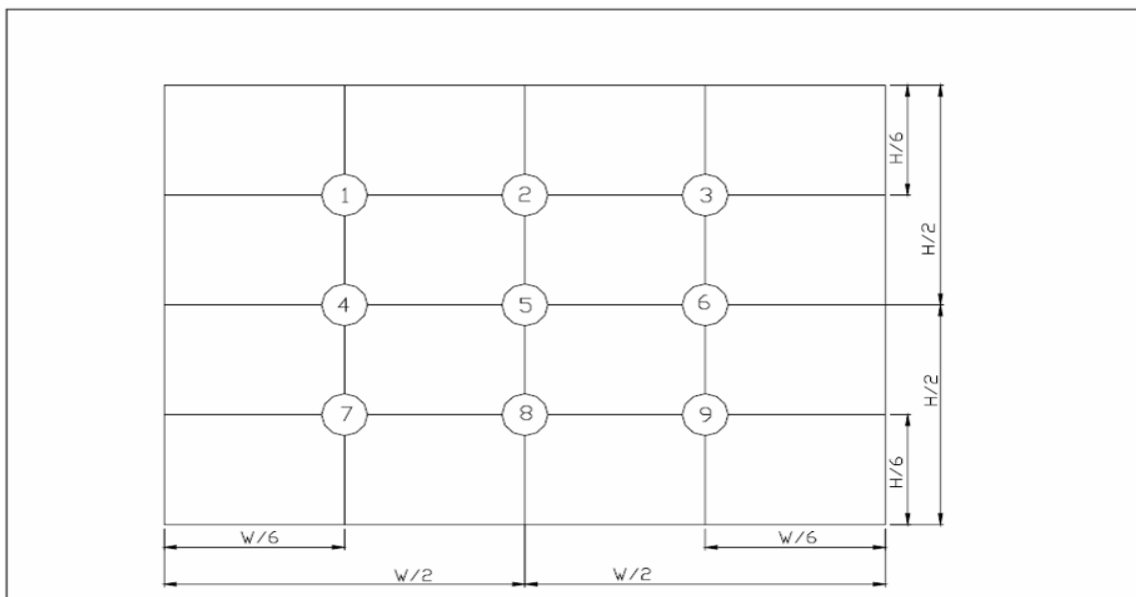

(單位 : mm)

13. Reliability Test

No.	Test Items	Test Condition	Remark
1	High Temperature Storage Test	$T_a = 80^{\circ}\text{C}$ 240 hours	(1),(3),(4)
2	Low Temperature Storage Test	$T_a = -40^{\circ}\text{C}$ 240 hours	(1),(3),(4)
3	High Temperature Operation Test	$T_s = 80^{\circ}\text{C}$ 240 hours	(2),(3),(4)
4	Low Temperature Operation Test	$T_a = -30^{\circ}\text{C}$ 240 hours	(1),(3),(4)
5	High Temperature and High Humidity Operation Test	$T_a = 60^{\circ}\text{C}$ 90%RH 240 hours	(3), (4)
6	Electro Static Discharge Test (non-operating)	-Panel Surface/Top Case : 150pF, 330Ω Air : ±15kV, Contact: ±8kV	(3)
7	Mechanical Shock Test (non-operating)	Half sine wave, 100G, 6ms 3 times shock of each six surfaces	(3)
8	Vibration Test (non-operating)	Sine wave:10 ~ 55 ~ 10Hz amplitude:1.5mm 3 axis, 2 hours/axis	(3)
9	Thermal Shock Test (non-operating)	-20°C (30min) ~ 70°C (30min) ,10 cycles	(3) , (4)
10	Drop Test(with Carton)	Height : 80cm 1 corner, 3 edges, 6 surfaces	(3)

Note 1: T_a is the ambient temperature of samples.

Note 2: T_s is the temperature of panel's surface.

Note 3: In the standard condition, there shall be no practical problem that may affect the display function.
After the reliability test, the product only guarantees operation, but don't guarantee all of the cosmetic specification.

Note 4: Before cosmetic and function test, the product must have enough recovery time, at least 2 hours at room temperature.

Note 5: When OP reaches -30 degree, the reaction of the display will be slower. However, this phenomenon is reversible after the ambient temperature returns to higher values.

14. Packaging

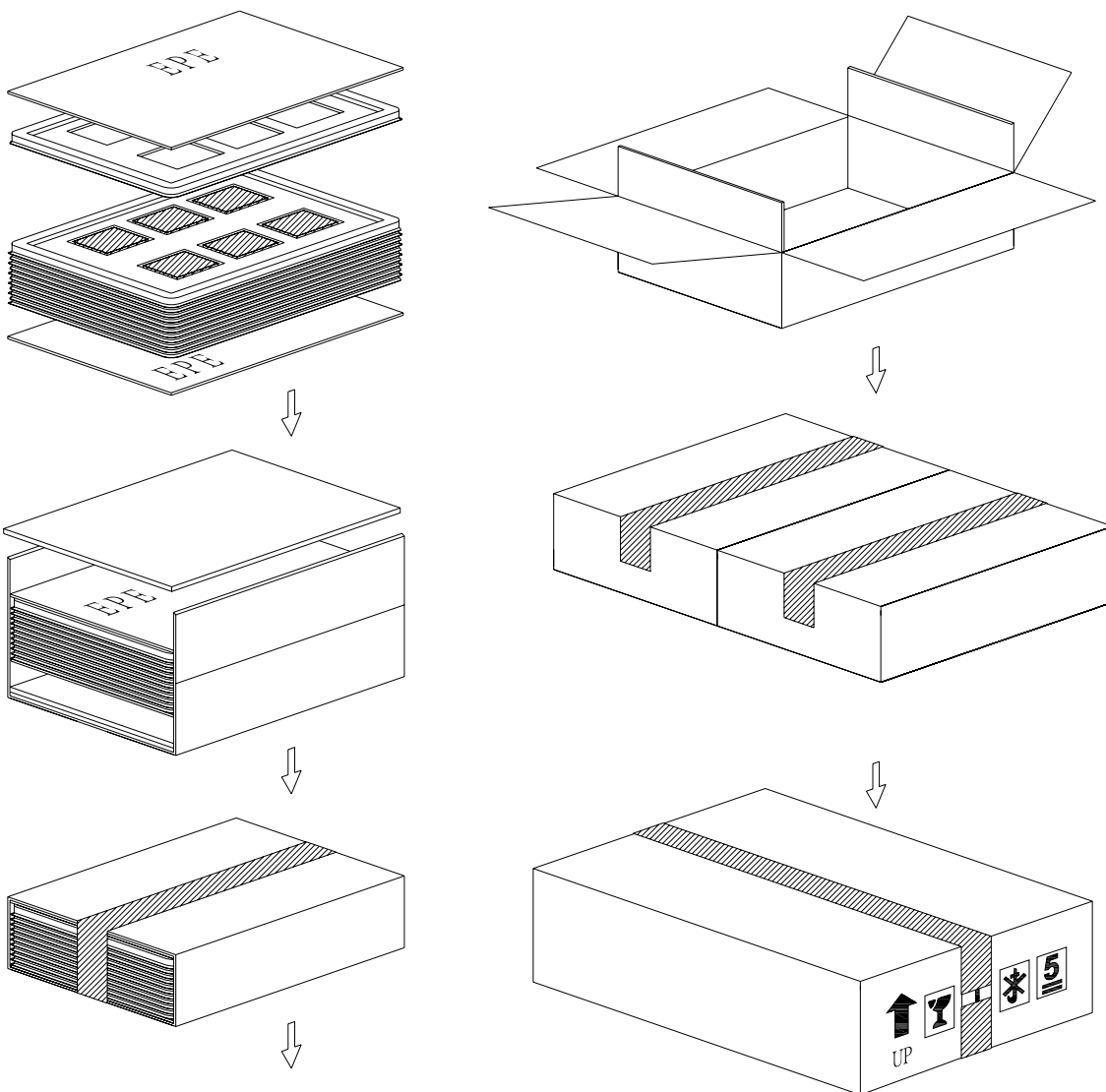

PARTS LIST

	ITEM	SIZE(LxWxH) unit:mm	MATERIAL	Q.T.Y	NOTE
1	TRAY	372.0x262.0x16.6		26	
2	EPE(J46)	372.0x262.0x5.0	EPE	4	
3	CARD BOARD(P01)	816.0x375.0x3.5	CARTON	2	
4	CARD BOARD(P02)	945.0x275.0x3.5	CARTON	2	
5	CARD BOARD(P03)	375.0x265.0x3.5	CARTON	4	
6	INTERNAL BOX(S01)	400.0x290.0x150.0	CARTON	2	
7	EXTERNAL BOX(L28)	600.0x420.0x180.0		1	
8	PRODUCT	76.9x63.9x4.85		144	

EVERVISION	MODEL NO.		PAGE
	VGG322433-6UFLWF	SPEC ONLY	28

15. Precautions

15.1 Assembly and Handling Precautions

- (1) Do not apply rough force such as bending or twisting to the module during assembly.
- (2) It's recommended to assemble or to install a module into the user's system in clean working areas. The dust and oil may cause electrical short or worsen the polarizer.
- (3) Don't apply pressure or impulse to the module to prevent the damage of LCD panel and Backlight.
- (4) Always follow the correct power-on sequence when the LCD module is turned on. This can prevent the damage and latch-up of the CMOS LSI chips.
- (5) Do not plug in or pull out the I/F connector while the module is in operation.
- (6) Do not disassemble the module.
- (7) Use a soft dry cloth without chemicals for cleaning, because the surface of polarizer is very soft and easily scratched.
- (8) Moisture can easily penetrate into LCD module and may cause the damage during operation.
- (9) High temperature or humidity may deteriorate the performance of LCD module. Please store LCD module in the specified storage conditions.
- (10) When ambient temperature is lower than 10°C, the display quality might be reduced. For example, the response time will become slow.

15.2 Safety Precautions

- (1) If the liquid crystal material leaks from the panel, it should be kept away from the eyes or mouth. In case of contact with hands, skin or clothes, it has to be washed away thoroughly with soap.
- (2) After the module's end of life, it is not harmful in case of normal operation and storage.

15.3 Terms of Warrant

- (1) Acceptance inspection period
The period is within one month after the arrival of contracted commodity at the buyer's factory site.
- (2) Applicable warrant period
The period is within twelve months since the date of shipping out under normal using and storage conditions.

EVERVISION	MODEL NO.		PAGE
	VGG322433-6UFLWF	SPEC ONLY	29

15.4 Caution

This Evervision LCD module has been specifically designed for use only in electronic devices in the areas of audio control, office automation, industrial control, home appliances, etc. The modules should not be used in applications where module failure could result in physical harm or loss of life, and Evervision expressly disclaims any and all liability relating in any way to the use of the module in such applications.

15.5 Cautions for LCM's installing and assembling

Please keep away the FPC while assembling or fixing the LCM to avoid FPC being damaged or extruded or other related problems. Please see below picture.

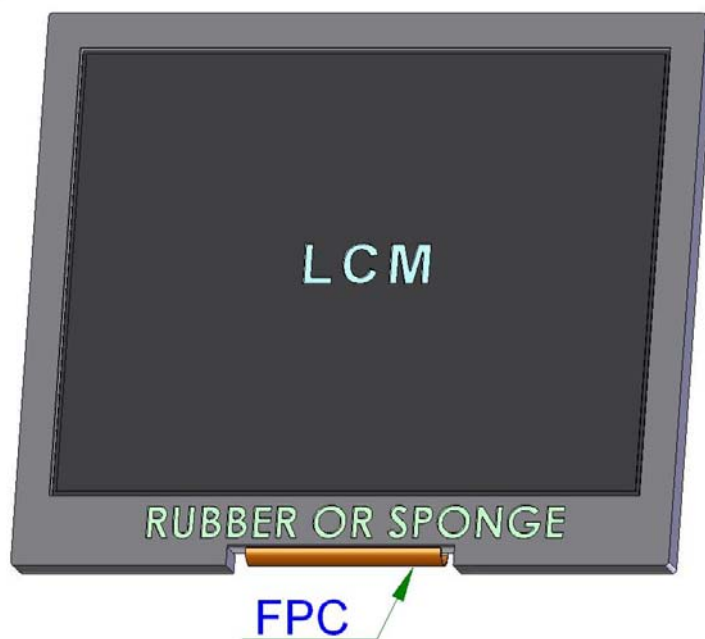

16.Outline Drawing

NOTE : Unspecified Tolerance : ±0.3

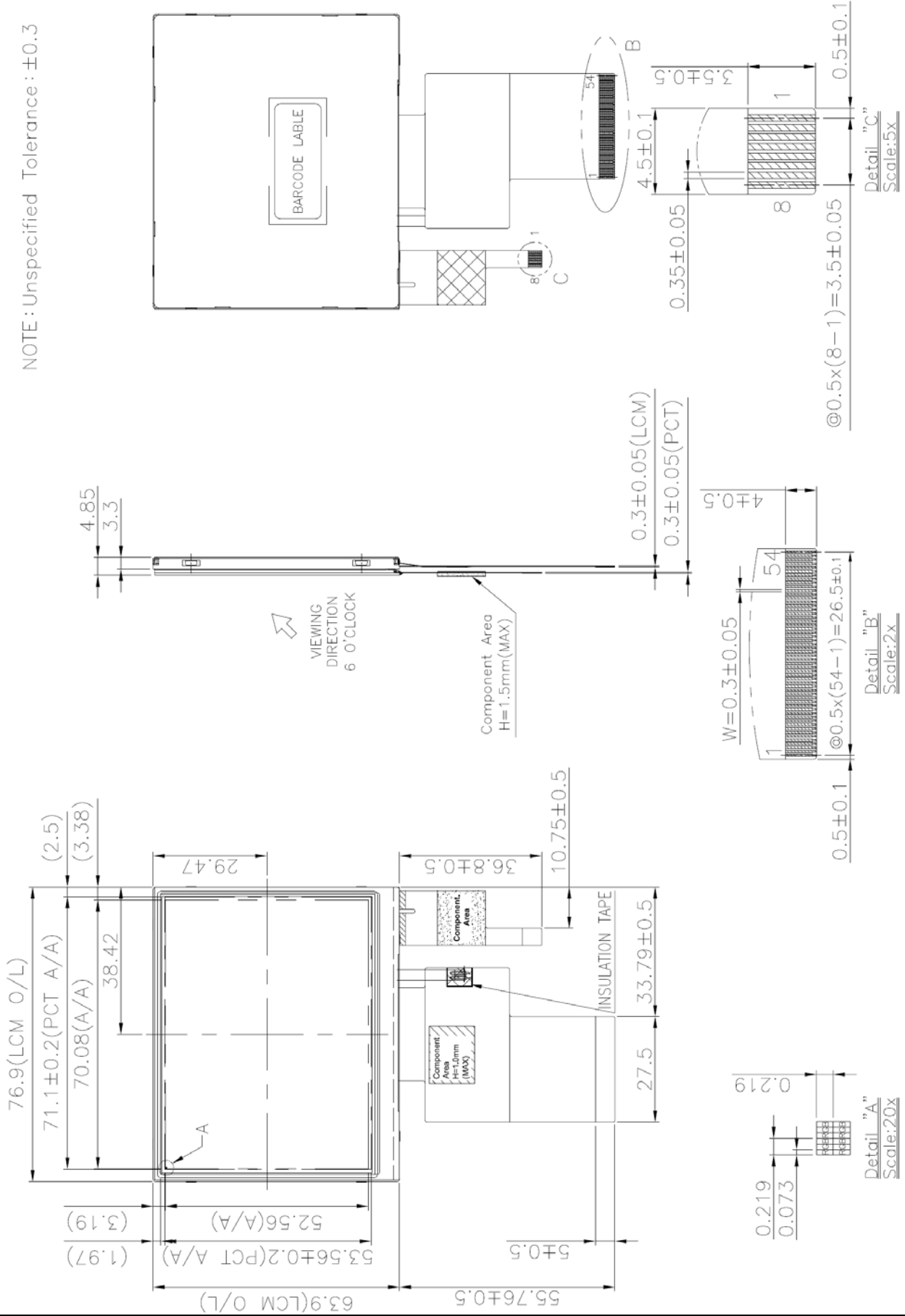

EVERVISION	MODEL NO.		PAGE
	VGG322433-6UFLWF	SPEC ONLY	31

17. Definition of Labels

The bar code nameplate is pasted on each module as illustration, and its definitions are as following explanation.



- (a) Module Name : VGG322433-6UFLWF
- (b) Serial ID :

A B C D E F G H I J K L

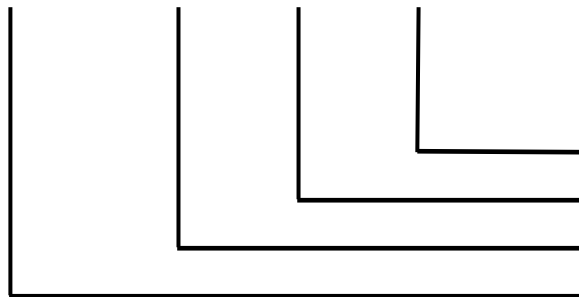

Serial No.
Factory Code
Manufactured Date
Screen Size

Serial ID includes the information as below :

- (a) Screen size (Diagonal) : Inch Code (ABCD)
3.5" → 0350
10.4" → 1040
- (b) Manufactured Date : Year 、 Month 、 Day (EFG)

Year (E)

Year	2000	2001	2002	2003	2004	2005	2006	2007	2008	2009
Mark	0	1	2	3	4	5	6	7	8	9
Year	2010	2011	2012	2013	2014	2015	2016	2017	2018	2019
Mark	A	B	C	D	E	F	G	H	I	J

EVERVISION	MODEL NO.		PAGE
	VGG322433-6UFLWF	SPEC ONLY	32

Month (F)

Month	Jan.	Feb.	Mar.	Apr.	May	Jun.	Jul.	Aug.	Sep.	Oct.	Nov.	Dec.
Mark	1	2	3	4	5	6	7	8	9	A	B	C

Day (G)

Day	1	2	3	4	5	6	7	8	9	10	11	12	13	14	15	16
Mark	1	2	3	4	5	6	7	8	9	A	B	C	D	E	F	G
Day	17	18	19	20	21	22	23	24	25	26	27	28	29	30	31	
Mark	H	I	J	K	L	M	N	O	P	Q	R	S	T	U	V	

(c) Factory Code (H):
For EVERVISION internal use.

(d) Serial No. (IJKL):
Manufacturing sequence of product, for example : 0001~9999.

18. Incoming Inspection Standards

18.1 The environmental condition of inspection

The environmental condition and visual inspection shall be conducted as below.

- (1) Ambient temperature $25 \pm 5^{\circ}\text{C}$
- (2) Humidity: 45 ~ 65 % RH
- (3) Viewing distance is approximately 30 ~ 40 cm
- (4) Viewing angle is normal to the LCD panel as Fig _1 ($\pm 45^{\circ}$)
- (5) Ambient Illumination: 300 ~ 500 Lux for external appearance inspection

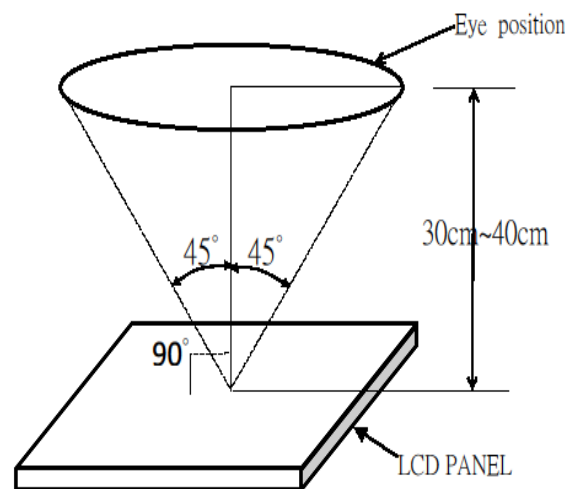

Fig_1

18.2 The defects classify of AQL as following:

- (1) Test method :According to ANSI/ASQC Z 1.4 .General Inspection Level II take a single time
- (2) The defects classify of AQL as following:

Class of defects	AQL	Definition
Major	0.65%	It is defect that is likely to result in failure or to reduce materially the usability of the intended function.
Minor	1.5%	It is a defect that will not result in functioning problem with deviation classified.

EVERVISION	MODEL NO.		PAGE
	VGG322433-6UFLWF	SPEC ONLY	34

18.3 Inspection Parameters

Item		Specification/Description			Note	
Display	Function	No Display			-	
		Malfunction			-	
Operating	Contrast ratio	Out of Spec			-	
	Line defect	No obvious Vertical and Horizontal line defect in bright , dark and colored.			-	
	Point Defect (red ,green ,blue ,dark ,white)	Item	Acceptable number			Note: 1、4、 5、6
			A	B	Total	
		BRIGHT DOT	$N \leq 0$	$N \leq 2$	$N \leq 6$	
		DARK DOT	$N \leq 2$	$N \leq 4$		
		TOTAL DOT	$N \leq 2$	$N \leq 4$		
TWO ADJACENT DOT	NOT ALLOWED					
THREE OR MORE ADJACENT DOT	NOT ALLOWED					
External Inspection (non-operating or operating)	Scratch (in display area)	L(mm)	W(mm)	Acceptable number	Note:2	
		$L \leq 2.5$	$W \leq 0.1$	3		
		$L > 2.5$	$W > 0.1$	0		
	Polarizer dent or bubble (in display area)	Dimension(mm)		Acceptable number	Note:3	
		$D \leq 0.25$		Disregard		
		$D \leq 0.5$		4		
	Line Shape (Particles and Lint in display area)	L(mm)	W(mm)	Acceptable number	Note:2	
		-	$W \leq 0.07$	Disregard		
		$L \leq 5$	$W \leq 0.1$	4		
		$L \geq 5$	$W \geq 0.1$	0		
Dot Shape (Particle in Display area)	Dimension(mm)		Acceptable number	Note:3		
	$D \leq 0.25$		Disregard			
	$D \leq 0.5$		4			

Note1. The definition of dot defect :

The dot defect was judged after repair and the size of a defective dot over 1/2 of whole dot is regarded as one defective dot.

Note2.

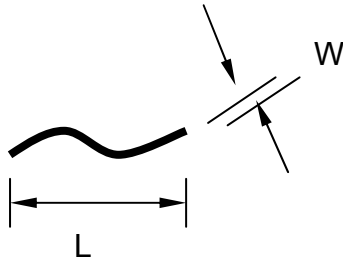

Note3. D : Diameter $D=(a+b)/2$

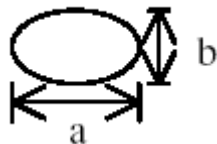

Note4. Bright dot is defined through 2% transmission ND Filter as following.

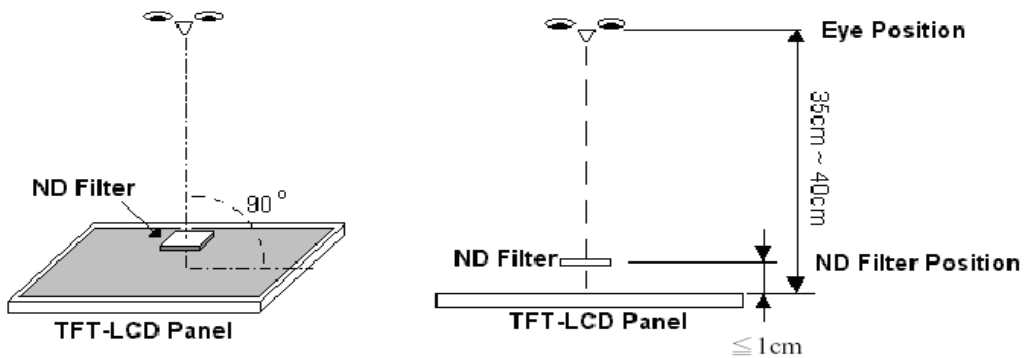

Note5. ADJACENT DOT



EVERVISION	MODEL NO.		PAGE
	VGG322433-6UFLWF	SPEC ONLY	37

Note6.

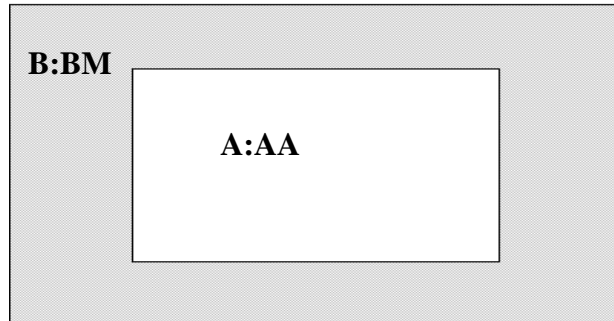

18.4 Handling of LCM

- (1) Don't give external shock.
- (2) Don't apply excessive force on the surface.
- (3) Liquid in LCD is hazardous substance. Must not lick and swallow. when the liquid is attach to your hand, skin, cloth etc. Wash it out thoroughly and immediately.
- (4) Don't operate it above the absolute maximum rating.
- (5) Don't disassemble the LCM.