

# DIN CNN & CNL fuses

## Forklift truck fuses

Mersen forklift truck and battery isolator fuses are specially designed for the heavy duty loads associated with DC battery powered equipment such as forklift trucks, hand trucks, motorized work platforms, and other DC battery operated systems. Rugged construction and stud mounted bolt-in design assure a long life in adverse conditions for these fuses. This expanded line of forklift truck fuses can fulfill virtually all of your heavy duty circuit protection needs up to 130V AC or DC. The flat CNL and CNN style fuses have a lower voltage rating but are also AC, UL recognized, more space saving and have visual 'see-thru' indication to show when they have operated. They can be fitted on SFBT fuse bases as per DIN 43560 fuse dimensions.

### Features Benefits

- All fuses are AC and DC rated
- Expanded ampere ratings
- General purpose types
- Link is visible through window

### Applications

- Battery systems
- Forklift trucks
- Battery hand trucks
- Motorized work platforms

### Technical data overview

Voltage Range AC	80 ... 130 VAC
Voltage DC	80 VDC
Ampere Range (A)	10 ... 800 A
Breaking capacity	2600A at L/R 5ms 1600A at L/R 10ms

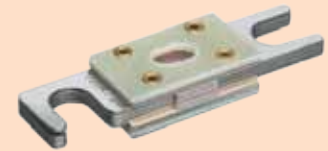

### Standards

UL Recognized



# DIN CNN & CNL fuses

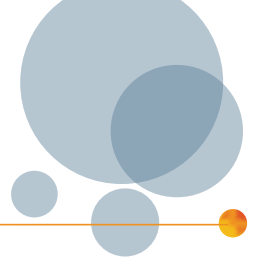

## Product range

### DIN CNL

Catalog number	Reference number	Rated voltage AC (UL)	Rated voltage DC (UL)	Rated current I <sub>n</sub>	Package
CNL35DIN	T216332	80 V	80 V	35 A	5
CNL40DIN	L217360	80 V	80 V	40 A	5
CNL50DIN	A218385	80 V	80 V	50 A	5
CNL60DIN	E219424	80 V	80 V	60 A	5
CNL80DIN	Y219947	80 V	80 V	80 A	5
CNL100DIN	K201995	80 V	80 V	100 A	5
CNL125DIN	K211218	80 V	80 V	125 A	5
CNL130DIN	A211738	80 V	80 V	130 A	5
CNL150DIN	J212252	80 V	80 V	150 A	5
CNL175DIN	W212769	80 V	80 V	175 A	5
CNL200DIN	J213287	80 V	80 V	200 A	5
CNL225DIN	A213785	80 V	80 V	225 A	5
CNL250DIN	J214299	80 V	80 V	250 A	5
CNL275DIN	J214299	80 V	80 V	275 A	5
CNL300DIN	L215313	80 V	80 V	300 A	5
CNL325DIN	P215822	80 V	80 V	325 A	5
CNL350DIN	X216841	80 V	80 V	350 A	5
CNL400DIN	T217873	80 V	80 V	400 A	5
CNL500DIN	Q218905	80 V	80 V	500 A	5
CNL600DIN	X1027384	80 V	80 V	600 A	5
CNL675DIN	Y1027385	80 V	80 V	600 A	5
CNL750DIN	Z1027386	80 V	80 V	750 A	5

# DIN CNN & CNL fuses

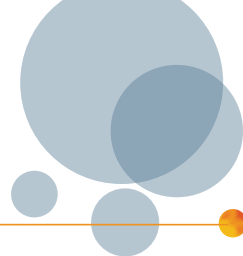

## Product range

### DIN CNN

Catalog number	Reference number	Rated voltage AC (UL)	Rated voltage DC (UL)	Rated current I <sub>n</sub>	Package
CNN10DIN	E228831	130 V	80 V	10 A	5
CNN35DIN	F228832	130 V	80 V	35 A	5
CNN40DIN	G228833	130 V	80 V	40 A	5
CNN50DIN	H228834	130 V	80 V	50 A	5
CNN60DIN	J228835	130 V	80 V	60 A	5
CNN80DIN	K228836	130 V	80 V	80 A	5
CNN90DIN	L228837	130 V	80 V	90 A	5
CNN100DIN	M228838	130 V	80 V	100 A	5
CNN125DIN	N228839	130 V	80 V	125 A	5
CNN150DIN	P228840	130 V	80 V	150 A	5
CNN175DIN	Q228841	130 V	80 V	175 A	5
CNN180DIN	N229874	130 V	80 V	180 A	5
CNN200DIN	R228842	130 V	80 V	200 A	5
CNN225DIN	S228843	130 V	80 V	225 A	5
CNN250DIN	T228844	130 V	80 V	250 A	5
CNN275DIN	V228845	130 V	80 V	275 A	5
CNN300DIN	W228846	130 V	80 V	300 A	5
CNN325DIN	X228874	130 V	80 V	325 A	5
CNN350DIN	Y228848	130 V	80 V	350 A	5
CNN400DIN	Z228849	130 V	80 V	400 A	5
CNN500DIN	A228850	130 V	80 V	500 A	5
CNN600DIN	B228851	130 V	80 V	600 A	5
CNN700DIN	C228852	130 V	80 V	700 A	5
CNN800DIN	D228853	130 V	80 V	800 A	5

# DIN CNN & CNL fuses

## Time current characteristic curves

CNL35-750

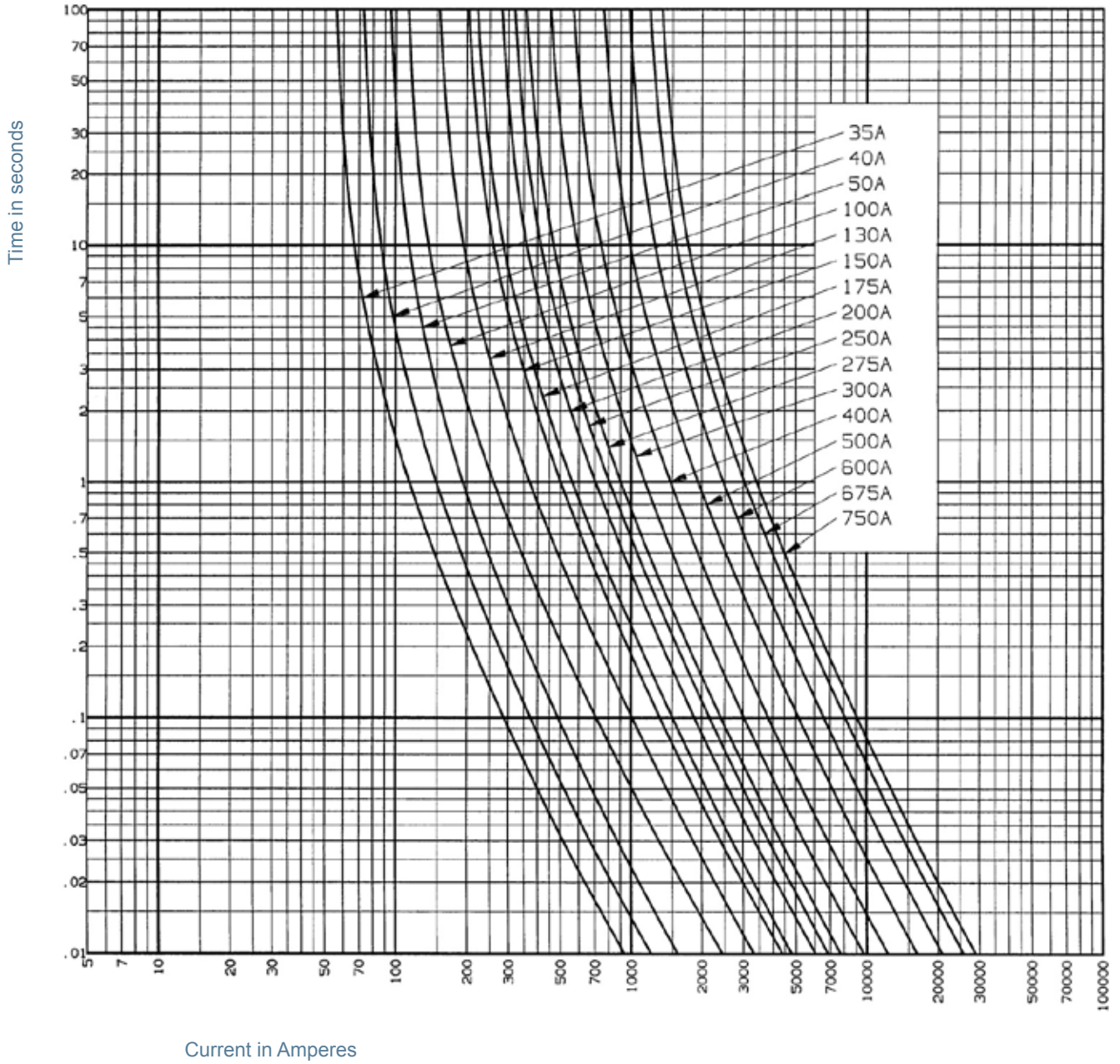

# DIN CNN & CNL fuses

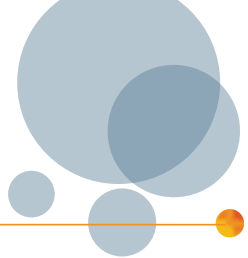

## Time current characteristic curves

CNN35-800

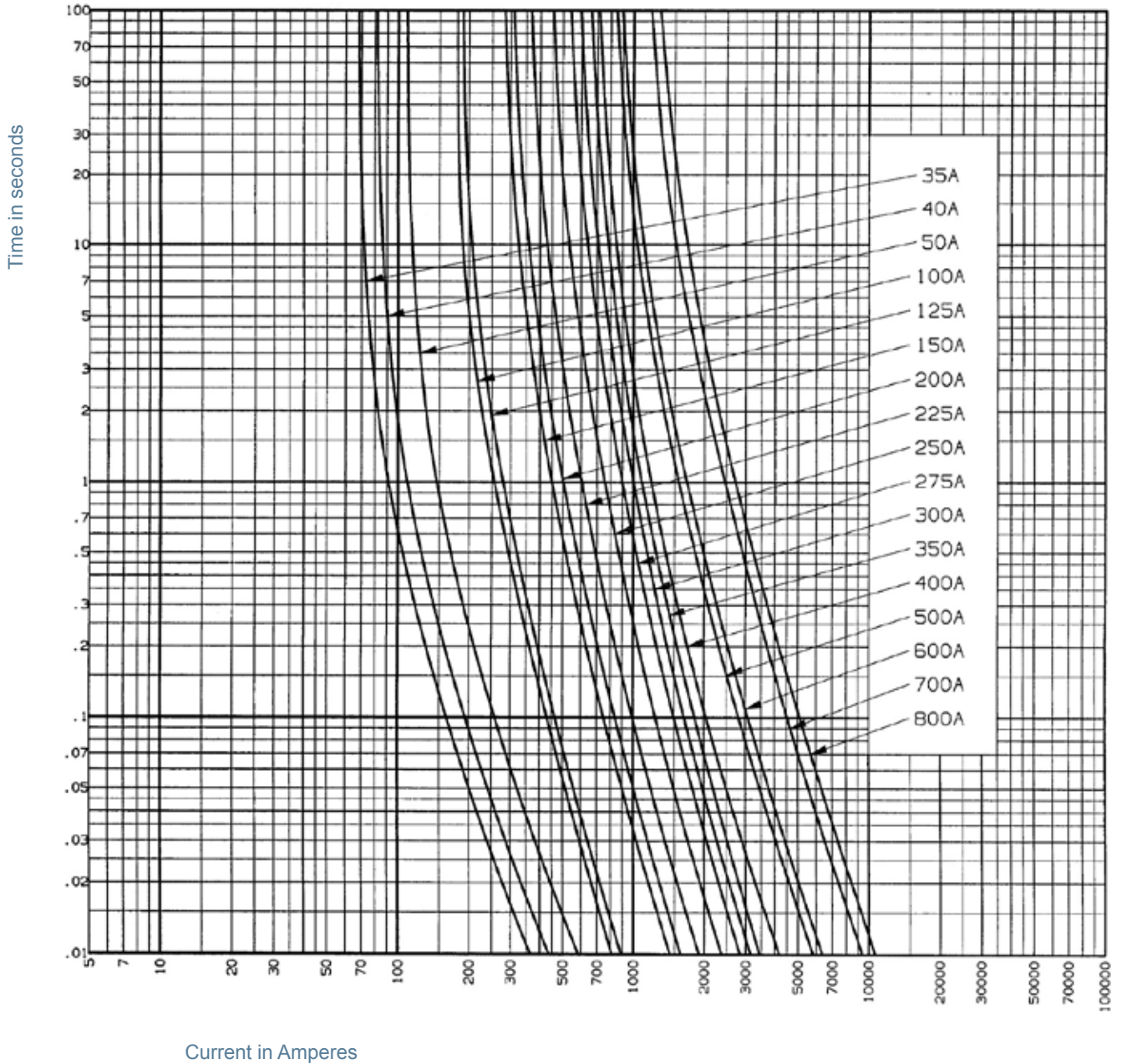

Current in Amperes

For 10A time current characteristic curve, please consult us.

# DIN CNN & CNL fuses

## Dimensions

CNN and CNL fuses - in mm

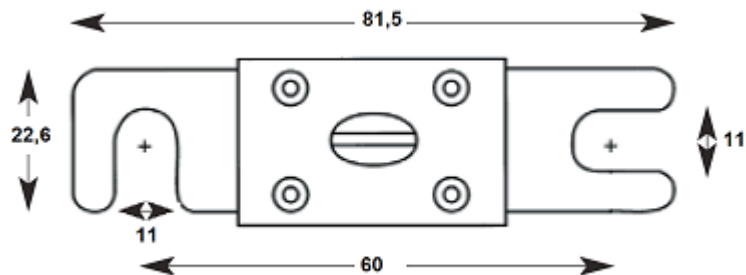

SFBT fuse base - in mm

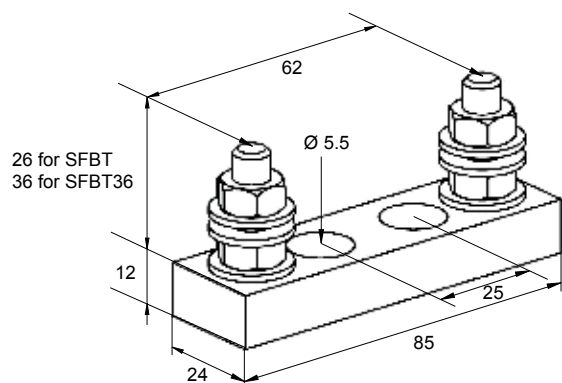

## Accessories

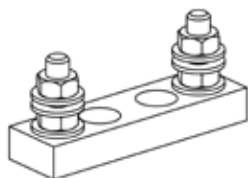

SFBT

### Fuse bases

Catalog number	Reference number	Description
SFBT	A092092	Fuse base for CNN and CNL fuses
SFBT36	J236287	Fuse base with extended threaded studs for CNN and CNL fuses