

## IGBT

High speed IGBT in Trench and Fieldstop technology

## IGB20N60H3

600V high speed switching series third generation

Data sheet

Industrial Power Control

### High speed IGBT in Trench and Fieldstop technology

#### Features:

TRENCHSTOP™ technology offering

- very low turn-off energy
- low  $V_{CEsat}$
- low EMI
- maximum junction temperature 175°C
- qualified according to JEDEC for target applications
- Pb-free lead plating, halogen-free mould compound, RoHS compliant
- complete product spectrum and PSpice Models:  
<http://www.infineon.com/igbt/>

#### Applications:

- uninterruptible power supplies
- welding converters
- converters with high switching frequency

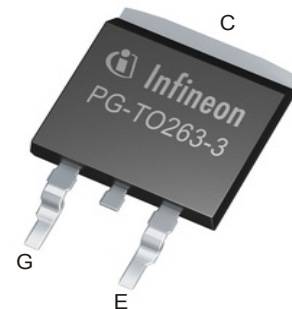

#### Key Performance and Package Parameters

| Type       | $V_{CE}$ | $I_C$ | $V_{CEsat}, T_{vj}=25^\circ\text{C}$ | $T_{vjmax}$ | Marking | Package    |
|------------|----------|-------|--------------------------------------|-------------|---------|------------|
| IGB20N60H3 | 600V     | 20A   | 1.95V                                | 175°C       | G20H603 | PG-TO263-3 |



**Table of Contents**

|   |    |
|---|----|
| Description .....                         | 2  |
| Table of Contents .....                   | 3  |
| Maximum ratings .....                     | 4  |
| Thermal Resistance .....                  | 4  |
| Electrical Characteristics .....          | 4  |
| Electrical Characteristics diagrams ..... | 6  |
| Package Drawing .....                     | 12 |
| Testing Conditions .....                  | 13 |
| Revision History .....                    | 14 |
| Disclaimer .....                          | 14 |

**Maximum ratings**

| Parameter   | Symbol      | Value         | Unit               |
|---|-------------|---------------|--------------------|
| Collector-emitter voltage, $T_{vj} \geq 25^{\circ}\text{C}$   | $V_{CE}$    | 600           | V                  |
| DC collector current, limited by $T_{vjmax}$<br>$T_C = 25^{\circ}\text{C}$<br>$T_C = 100^{\circ}\text{C}$   | $I_C$       | 40.0<br>20.0  | A                  |
| Pulsed collector current, $t_p$ limited by $T_{vjmax}$  | $I_{Cpuls}$ | 80.0          | A                  |
| Turn off safe operating area<br>$V_{CE} \leq 600\text{V}$ , $T_{vj} \leq 175^{\circ}\text{C}$ , $t_p = 1\mu\text{s}$  | -           | 80.0          | A                  |
| Gate-emitter voltage  | $V_{GE}$    | $\pm 20$      | V                  |
| Short circuit withstand time<br>$V_{GE} = 15.0\text{V}$ , $V_{CC} \leq 400\text{V}$<br>Allowed number of short circuits < 1000<br>Time between short circuits: $\geq 1.0\text{s}$<br>$T_{vj} = 150^{\circ}\text{C}$ | $t_{SC}$    | 5             | $\mu\text{s}$      |
| Power dissipation $T_C = 25^{\circ}\text{C}$<br>Power dissipation $T_C = 100^{\circ}\text{C}$   | $P_{tot}$   | 170.0<br>85.0 | W                  |
| Operating junction temperature  | $T_{vj}$    | -40...+175    | $^{\circ}\text{C}$ |
| Storage temperature   | $T_{stg}$   | -55...+150    | $^{\circ}\text{C}$ |
| Soldering temperature,<br>reflow soldering (MSL1 according to JEDEC J-STA-020)  |             | 260           | $^{\circ}\text{C}$ |

**Thermal Resistance**

| Parameter   | Symbol        | Conditions | Max. Value | Unit |
|---|---------------|------------|------------|------|
| <b>Characteristic</b>   |               |            |            |      |
| IGBT thermal resistance,<br>junction - case                             | $R_{th(j-c)}$ |            | 0.88       | K/W  |
| Thermal resistance, min. footprint<br>junction - ambient                | $R_{th(j-a)}$ |            | 65         | K/W  |
| Thermal resistance, 6cm <sup>2</sup> Cu on<br>PCB<br>junction - ambient | $R_{th(j-a)}$ |            | 40         | K/W  |

**Electrical Characteristic, at  $T_{vj} = 25^{\circ}\text{C}$ , unless otherwise specified**

| Parameter                            | Symbol        | Conditions  | Value       |                      |                | Unit          |
|--------------------------------------|---------------|---|-------------|----------------------|----------------|---------------|
|                                      |               |   | min.        | typ.                 | max.           |               |
| <b>Static Characteristic</b>         |               |   |             |                      |                |               |
| Collector-emitter breakdown voltage  | $V_{(BR)CES}$ | $V_{GE} = 0\text{V}$ , $I_C = 2.00\text{mA}$  | 600         | -                    | -              | V             |
| Collector-emitter saturation voltage | $V_{CEsat}$   | $V_{GE} = 15.0\text{V}$ , $I_C = 20.0\text{A}$<br>$T_{vj} = 25^{\circ}\text{C}$<br>$T_{vj} = 125^{\circ}\text{C}$<br>$T_{vj} = 175^{\circ}\text{C}$ | -<br>-<br>- | 1.95<br>2.30<br>2.50 | 2.40<br>-<br>- | V             |
| Gate-emitter threshold voltage       | $V_{GE(th)}$  | $I_C = 0.29\text{mA}$ , $V_{CE} = V_{GE}$   | 4.1         | 5.1                  | 5.7            | V             |
| Zero gate voltage collector current  | $I_{CES}$     | $V_{CE} = 600\text{V}$ , $V_{GE} = 0\text{V}$<br>$T_{vj} = 25^{\circ}\text{C}$<br>$T_{vj} = 175^{\circ}\text{C}$                                    | -<br>-      | -<br>-               | 40.0<br>1500.0 | $\mu\text{A}$ |
| Gate-emitter leakage current         | $I_{GES}$     | $V_{CE} = 0\text{V}$ , $V_{GE} = 20\text{V}$  | -           | -                    | 100            | nA            |
| Transconductance                     | $g_{fs}$      | $V_{CE} = 20\text{V}$ , $I_C = 20.0\text{A}$  | -           | 10.9                 | -              | S             |

**Electrical Characteristic, at  $T_{vj} = 25^{\circ}\text{C}$ , unless otherwise specified**

| Parameter  | Symbol      | Conditions   | Value |       |      | Unit |
|--|-------------|--|-------|-------|------|------|
|  |             |  | min.  | typ.  | max. |      |
| <b>Dynamic Characteristic</b>  |             |  |       |       |      |      |
| Input capacitance  | $C_{ies}$   | $V_{CE} = 25\text{V}, V_{GE} = 0\text{V}, f = 1\text{MHz}$   | -     | 1100  | -    | pF   |
| Output capacitance   | $C_{oes}$   |  | -     | 70    | -    |      |
| Reverse transfer capacitance   | $C_{res}$   |  | -     | 32    | -    |      |
| Gate charge  | $Q_G$       | $V_{CC} = 480\text{V}, I_C = 20.0\text{A}, V_{GE} = 15\text{V}$  | -     | 120.0 | -    | nC   |
| Short circuit collector current<br>Max. 1000 short circuits<br>Time between short circuits: $\geq 1.0\text{s}$ | $I_{C(SC)}$ | $V_{GE} = 15.0\text{V}, V_{CC} \leq 400\text{V}, t_{SC} \leq 5\mu\text{s}, T_{vj} = 150^{\circ}\text{C}$ | -     | 120   | -    | A    |

**Switching Characteristic, Inductive Load**

| Parameter | Symbol | Conditions | Value |      |      | Unit |
|-----------|--------|------------|-------|------|------|------|
|           |        |            | min.  | typ. | max. |      |

**IGBT Characteristic, at  $T_{vj} = 25^{\circ}\text{C}$** 

|                        |              |   |   |      |   |    |
|------------------------|--------------|---|---|------|---|----|
| Turn-on delay time     | $t_{d(on)}$  | $T_{vj} = 25^{\circ}\text{C}, V_{CC} = 400\text{V}, I_C = 20.0\text{A}, V_{GE} = 0.0/15.0\text{V}, r_G = 14.6\Omega, L\sigma = 75\text{nH}, C\sigma = 30\text{pF}, L\sigma, C\sigma$ from Fig. E<br>Energy losses include "tail" and diode (IKP20N60H3) reverse recovery. | - | 16   | - | ns |
| Rise time              | $t_r$        |   | - | 20   | - | ns |
| Turn-off delay time    | $t_{d(off)}$ |   | - | 194  | - | ns |
| Fall time              | $t_f$        |   | - | 11   | - | ns |
| Turn-on energy         | $E_{on}$     |   | - | 0.45 | - | mJ |
| Turn-off energy        | $E_{off}$    |   | - | 0.24 | - | mJ |
| Total switching energy | $E_{ts}$     |   | - | 0.69 | - | mJ |

**Switching Characteristic, Inductive Load**

| Parameter | Symbol | Conditions | Value |      |      | Unit |
|-----------|--------|------------|-------|------|------|------|
|           |        |            | min.  | typ. | max. |      |

**IGBT Characteristic, at  $T_{vj} = 175^{\circ}\text{C}$** 

|                        |              |  |   |      |   |    |
|------------------------|--------------|--|---|------|---|----|
| Turn-on delay time     | $t_{d(on)}$  | $T_{vj} = 175^{\circ}\text{C}, V_{CC} = 400\text{V}, I_C = 20.0\text{A}, V_{GE} = 0.0/15.0\text{V}, r_G = 14.6\Omega, L\sigma = 75\text{nH}, C\sigma = 30\text{pF}, L\sigma, C\sigma$ from Fig. E<br>Energy losses include "tail" and diode (IKP20N60H3) reverse recovery. | - | 16   | - | ns |
| Rise time              | $t_r$        |  | - | 15   | - | ns |
| Turn-off delay time    | $t_{d(off)}$ |  | - | 227  | - | ns |
| Fall time              | $t_f$        |  | - | 14   | - | ns |
| Turn-on energy         | $E_{on}$     |  | - | 0.60 | - | mJ |
| Turn-off energy        | $E_{off}$    |  | - | 0.36 | - | mJ |
| Total switching energy | $E_{ts}$     |  | - | 0.96 | - | mJ |

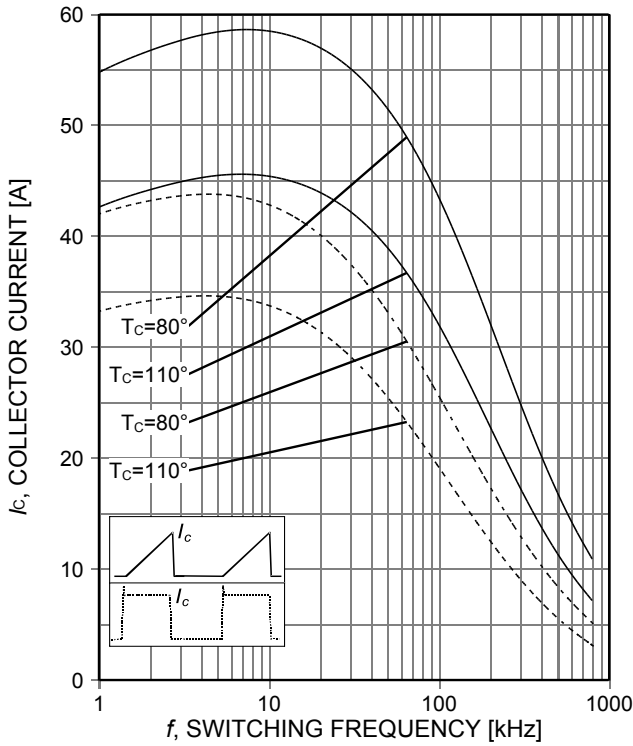

Figure 1. **Collector current as a function of switching frequency**  
 ( $T_j \leq 175^\circ\text{C}$ ,  $D=0.5$ ,  $V_{CE}=400\text{V}$ ,  $V_{GE}=15/0\text{V}$ ,  $r_G=14,6\Omega$ )

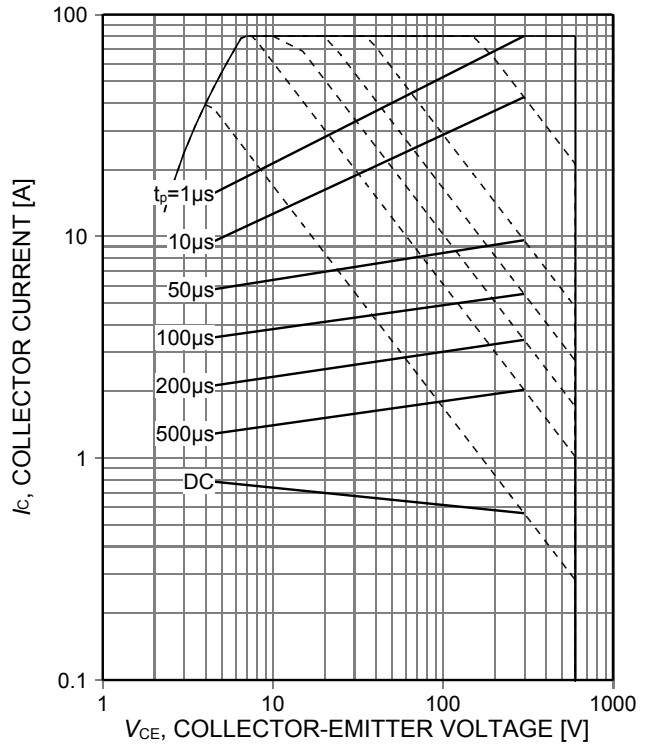

Figure 2. **Forward bias safe operating area**  
 ( $D=0$ ,  $T_C=25^\circ\text{C}$ ,  $T_j \leq 175^\circ\text{C}$ ;  $V_{GE}=15\text{V}$ )

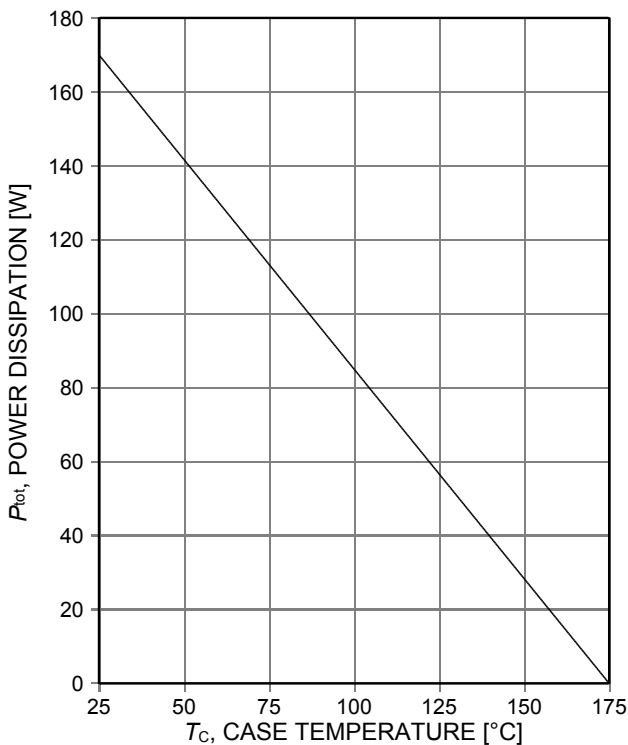

Figure 3. **Power dissipation as a function of case temperature**  
 ( $T_j \leq 175^\circ\text{C}$ )

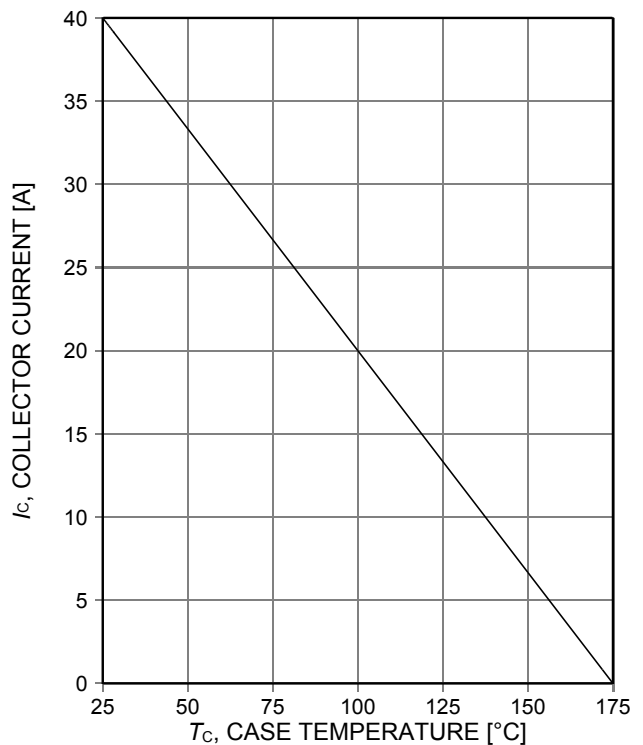

Figure 4. **Collector current as a function of case temperature**  
 ( $V_{GE} \geq 15\text{V}$ ,  $T_j \leq 175^\circ\text{C}$ )

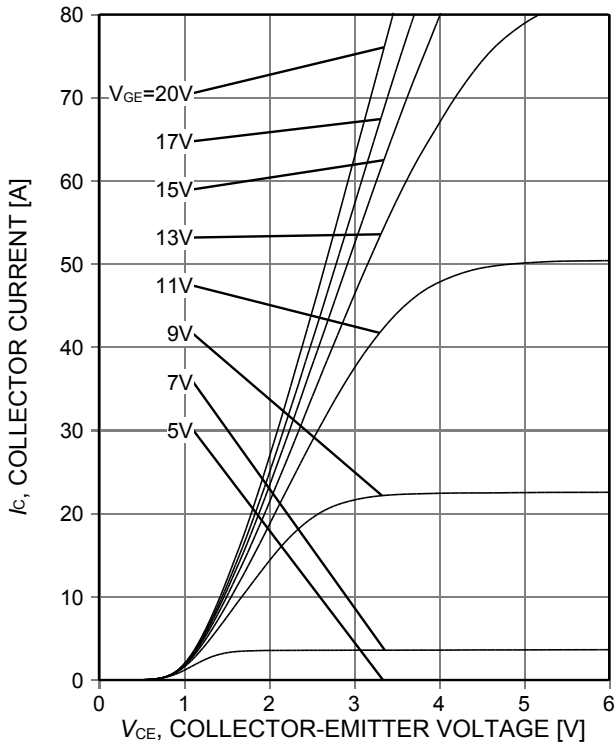

Figure 5. **Typical output characteristic**  
( $T_j=25^\circ\text{C}$ )

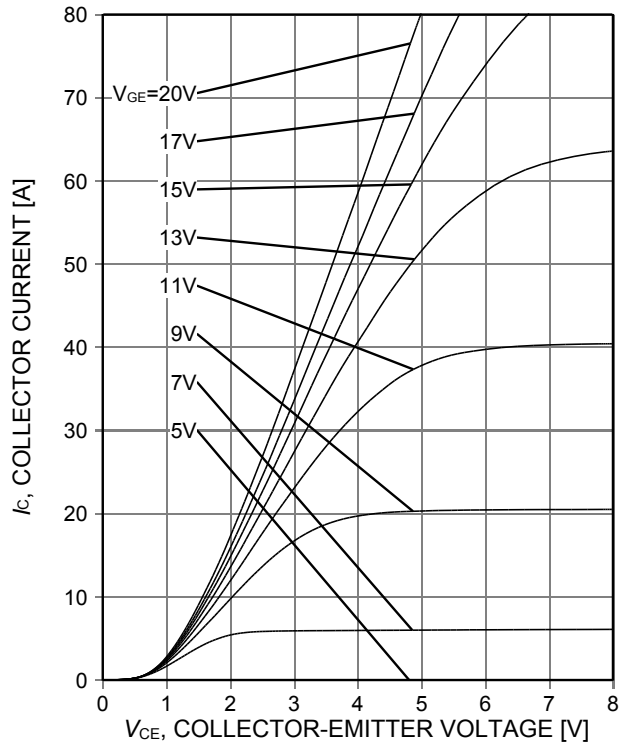

Figure 6. **Typical output characteristic**  
( $T_j=175^\circ\text{C}$ )

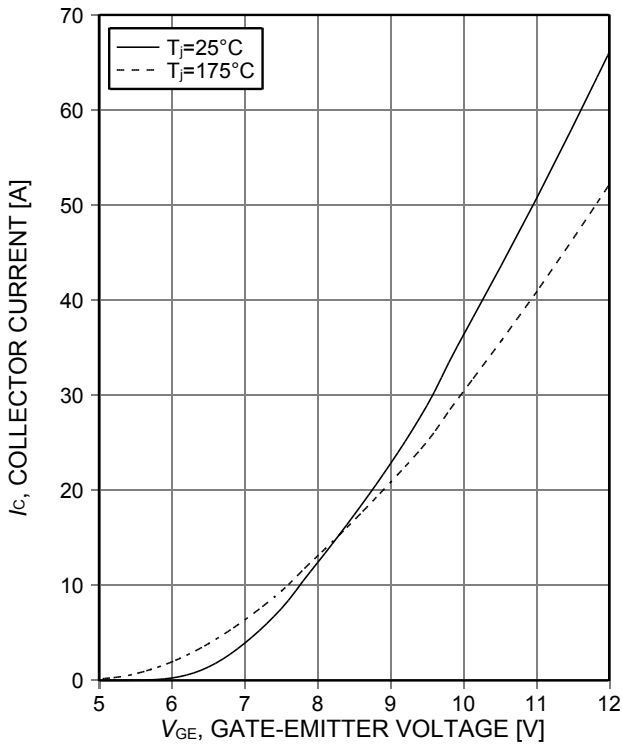

Figure 7. **Typical transfer characteristic**  
( $V_{CE}=20\text{V}$ )

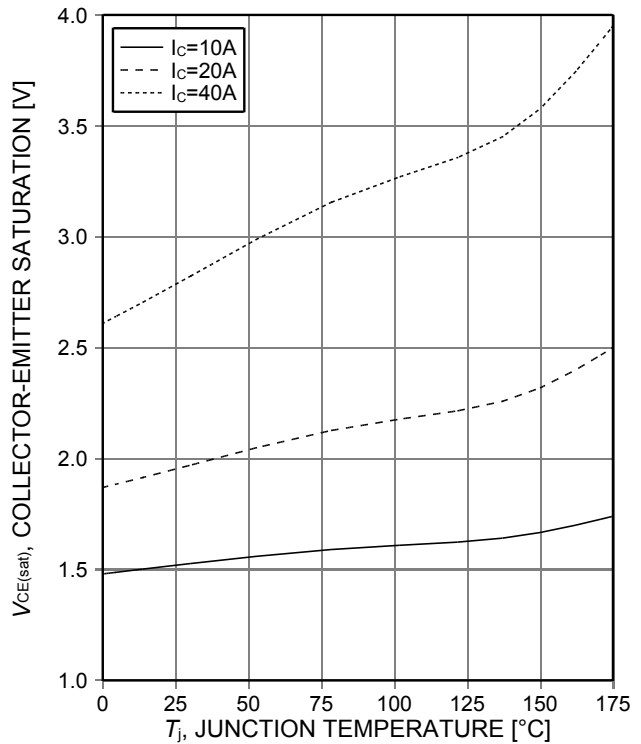

Figure 8. **Typical collector-emitter saturation voltage as a function of junction temperature**  
( $V_{GE}=15\text{V}$ )

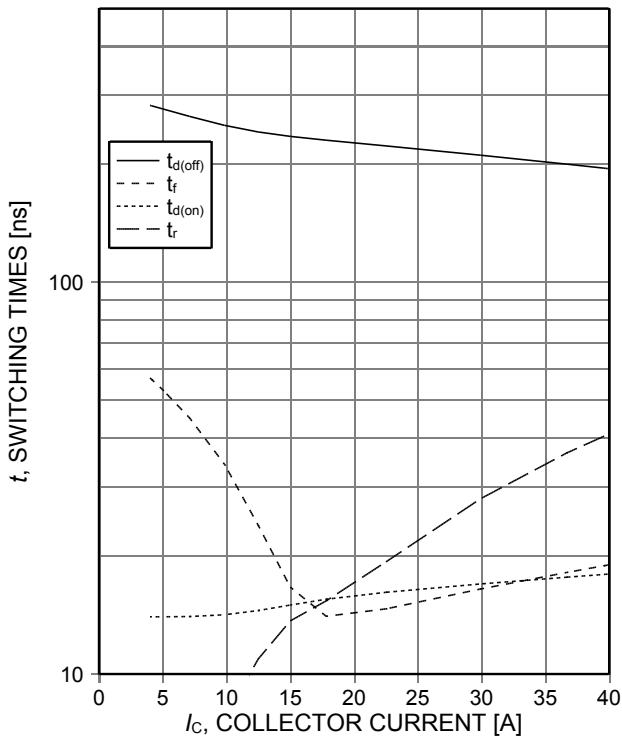

Figure 9. **Typical switching times as a function of collector current**  
 (ind. load,  $T_j=175^\circ\text{C}$ ,  $V_{CE}=400\text{V}$ ,  $V_{GE}=15/0\text{V}$ ,  $r_G=14,6\Omega$ , test circuit in Fig. E)

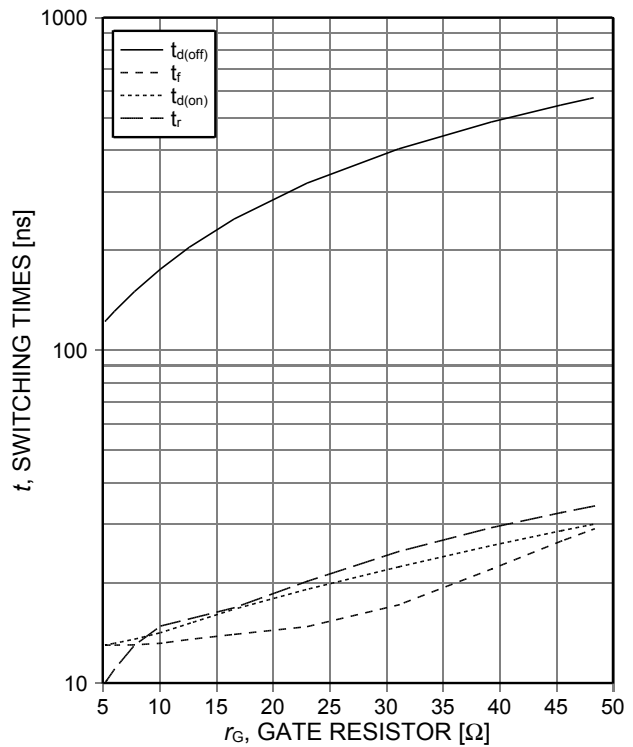

Figure 10. **Typical switching times as a function of gate resistor**  
 (ind. load,  $T_j=175^\circ\text{C}$ ,  $V_{CE}=400\text{V}$ ,  $V_{GE}=15/0\text{V}$ ,  $I_C=20\text{A}$ , test circuit in Fig. E)

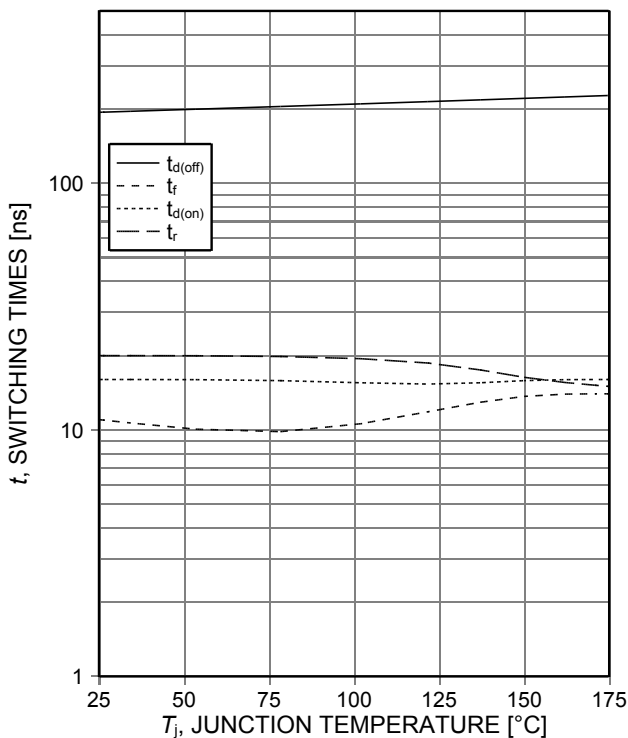

Figure 11. **Typical switching times as a function of junction temperature**  
 (ind. load,  $V_{CE}=400\text{V}$ ,  $V_{GE}=15/0\text{V}$ ,  $I_C=20\text{A}$ ,  $r_G=14,6\Omega$ , test circuit in Fig. E)



Figure 12. **Gate-emitter threshold voltage as a function of junction temperature**  
 ( $I_C=0.29\text{mA}$ )



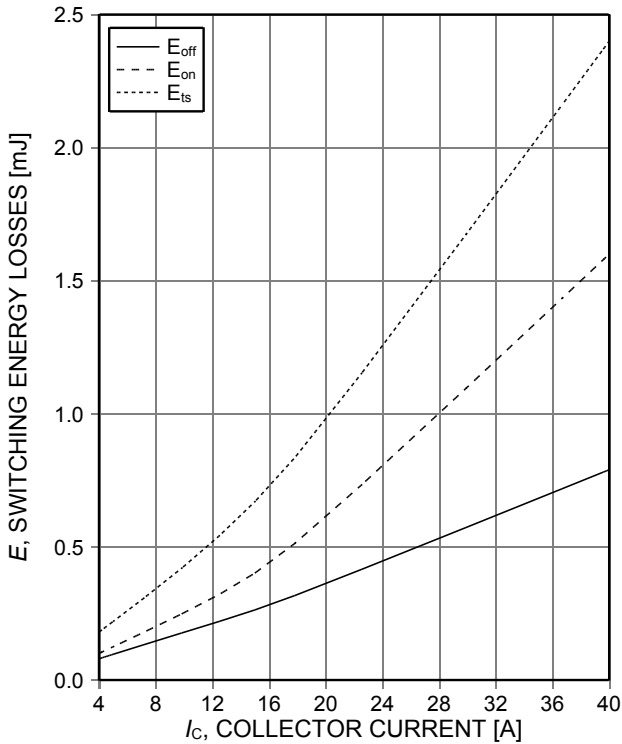

Figure 13. **Typical switching energy losses as a function of collector current**  
 (ind. load,  $T_j=175^\circ\text{C}$ ,  $V_{CE}=400\text{V}$ ,  $V_{GE}=15/0\text{V}$ ,  $r_G=14,6\Omega$ , test circuit in Fig. E)

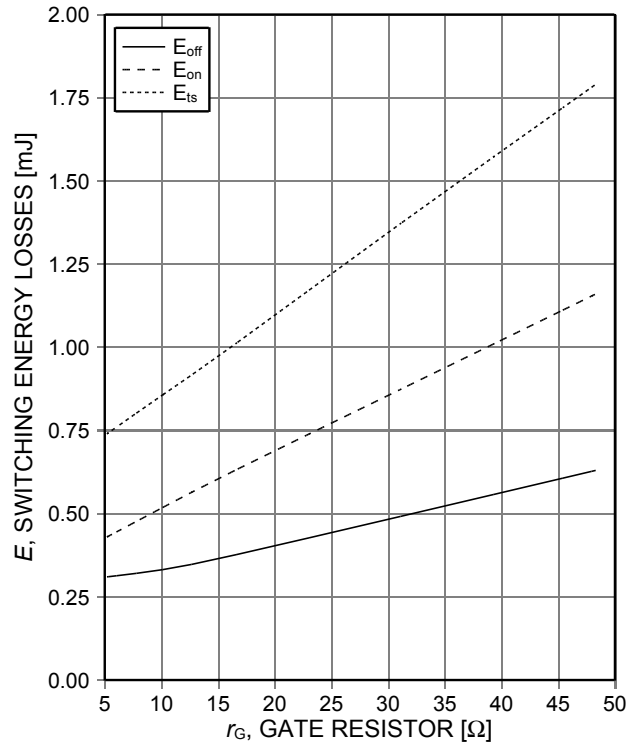

Figure 14. **Typical switching energy losses as a function of gate resistor**  
 (ind. load,  $T_j=175^\circ\text{C}$ ,  $V_{CE}=400\text{V}$ ,  $V_{GE}=15/0\text{V}$ ,  $I_C=20\text{A}$ , test circuit in Fig. E)

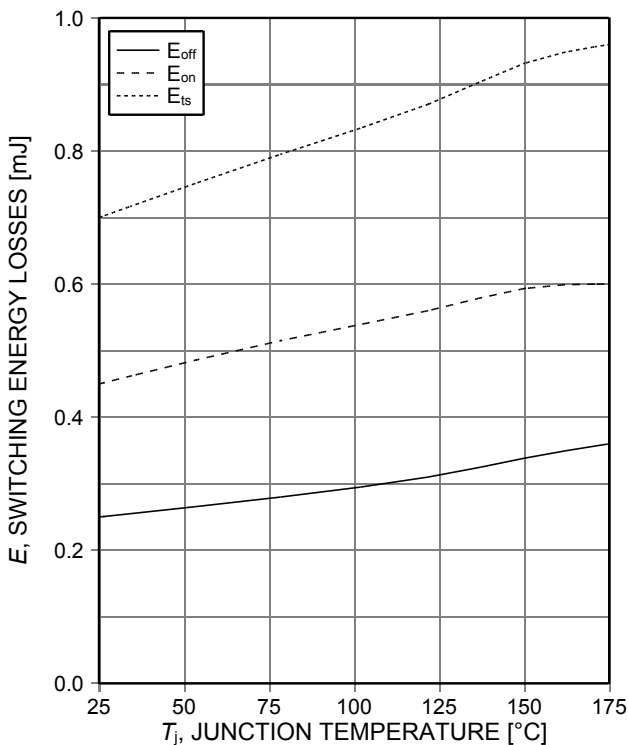

Figure 15. **Typical switching energy losses as a function of junction temperature**  
 (ind load,  $V_{CE}=400\text{V}$ ,  $V_{GE}=15/0\text{V}$ ,  $I_C=20\text{A}$ ,  $r_G=14,6\Omega$ , test circuit in Fig. E)

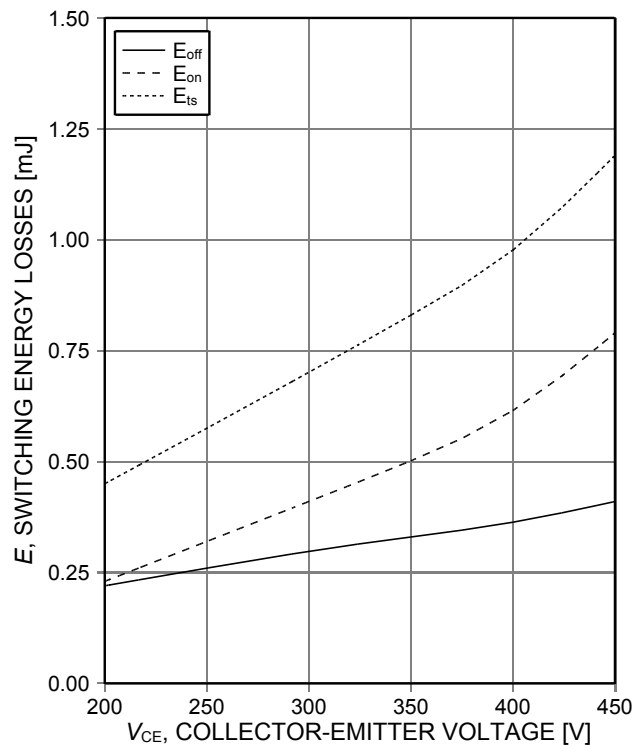

Figure 16. **Typical switching energy losses as a function of collector emitter voltage**  
 (ind. load,  $T_j=175^\circ\text{C}$ ,  $V_{GE}=15/0\text{V}$ ,  $I_C=20\text{A}$ ,  $r_G=14,6\Omega$ , test circuit in Fig. E)

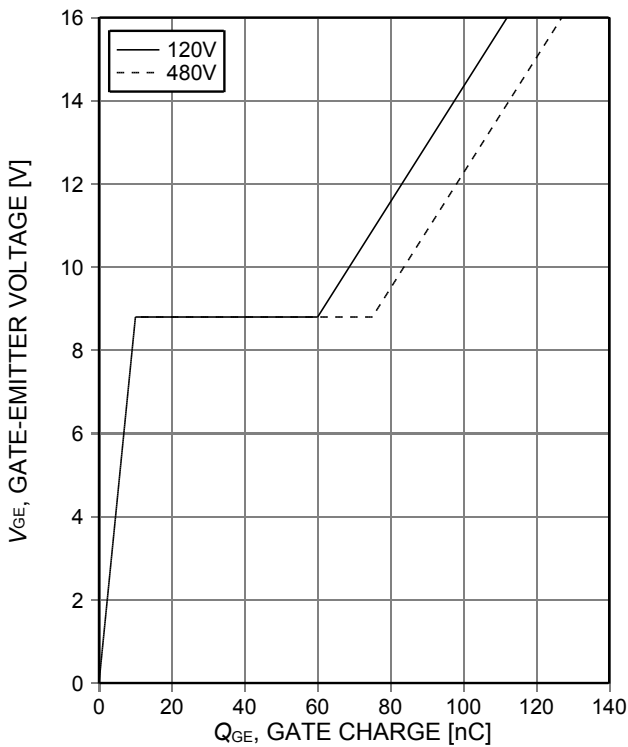

Figure 17. **Typical gate charge**  
( $I_C=20A$ )

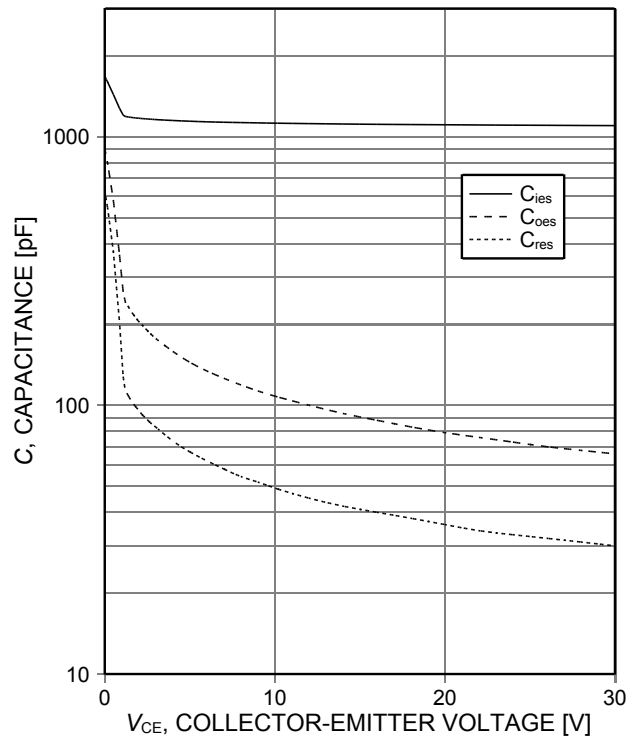

Figure 18. **Typical capacitance as a function of collector-emitter voltage**  
( $V_{GE}=0V$ ,  $f=1MHz$ )

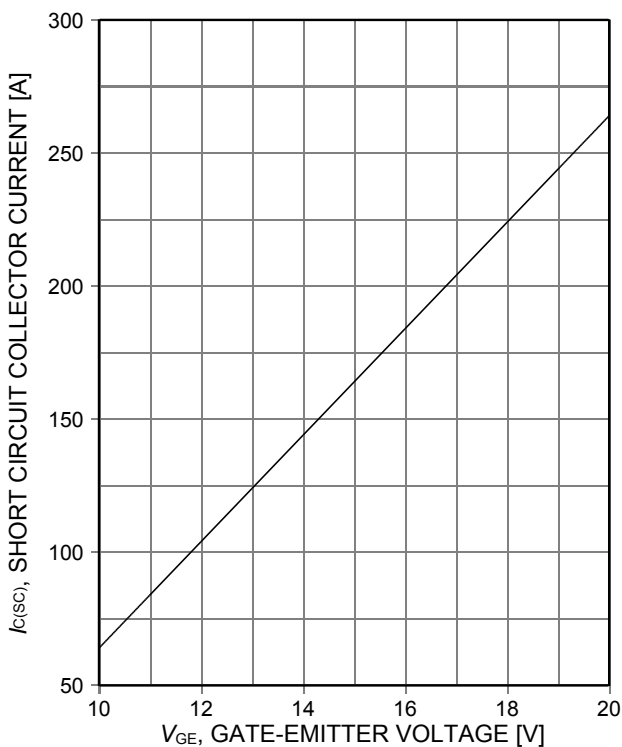

Figure 19. **Typical short circuit collector current as a function of gate-emitter voltage**  
( $V_{CE}\leq 400V$ , start at  $T_j=25^\circ C$ )



Figure 20. **Short circuit withstand time as a function of gate-emitter voltage**  
( $V_{CE}\leq 400V$ , start at  $T_j\leq 150^\circ C$ )

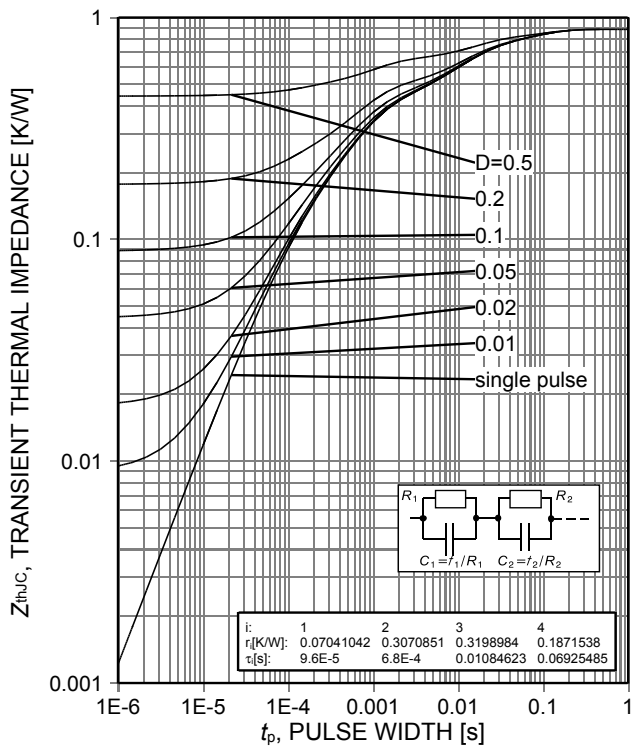
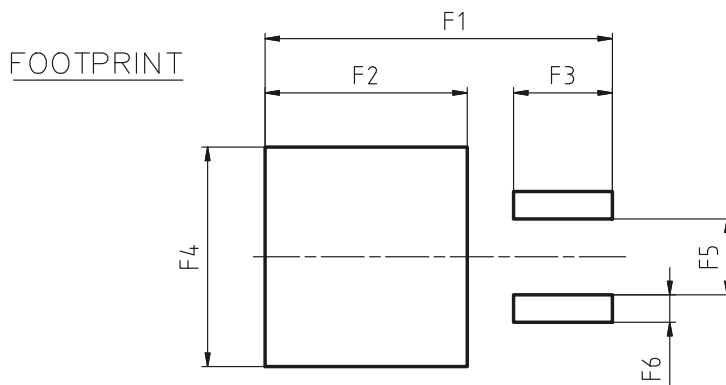
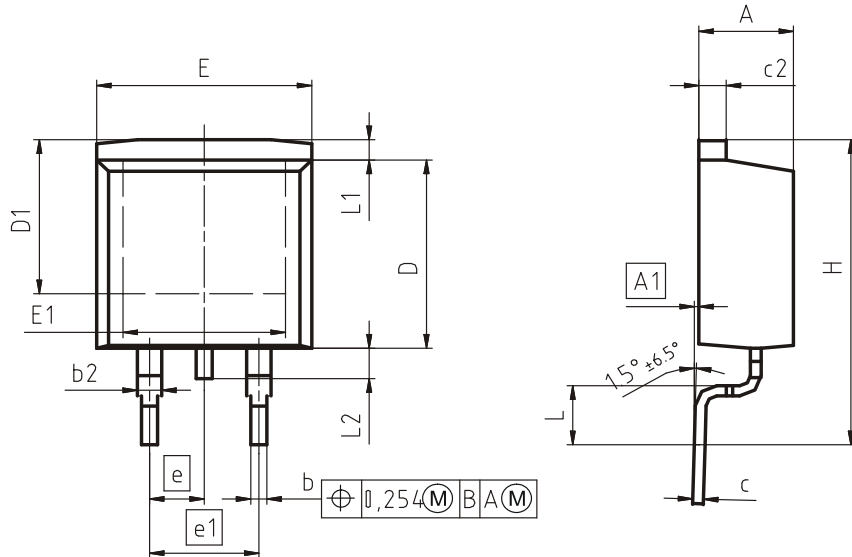

Figure 21. IGBT transient thermal impedance ( $D=t_p/T$ )

PG-TO263-3



| DIM | MILLIMETERS |       | INCHES |       |
|-----|-------------|-------|--------|-------|
|     | MIN         | MAX   | MIN    | MAX   |
| A   | 4.30        | 4.57  | 0.169  | 0.180 |
| A1  | 0.00        | 0.25  | 0.000  | 0.010 |
| b   | 0.65        | 0.85  | 0.026  | 0.033 |
| b2  | 0.95        | 1.15  | 0.037  | 0.045 |
| c   | 0.33        | 0.65  | 0.013  | 0.026 |
| c2  | 1.17        | 1.40  | 0.046  | 0.055 |
| D   | 8.51        | 9.45  | 0.335  | 0.372 |
| D1  | 7.10        | 7.90  | 0.280  | 0.311 |
| E   | 9.80        | 10.31 | 0.386  | 0.406 |
| E1  | 6.50        | 8.60  | 0.256  | 0.339 |
| e   | 2.54        |       | 0.100  |       |
| e1  | 5.08        |       | 0.200  |       |
| N   | 2           |       | 2      |       |
| H   | 14.61       | 15.88 | 0.575  | 0.625 |
| L   | 2.29        | 3.00  | 0.090  | 0.118 |
| L1  | 0.70        | 1.60  | 0.028  | 0.063 |
| L2  | 1.00        | 1.78  | 0.039  | 0.070 |
| F1  | 16.05       | 16.25 | 0.632  | 0.640 |
| F2  | 9.30        | 9.50  | 0.366  | 0.374 |
| F3  | 4.50        | 4.70  | 0.177  | 0.185 |
| F4  | 10.70       | 10.90 | 0.421  | 0.429 |
| F5  | 3.65        | 3.85  | 0.144  | 0.152 |
| F6  | 1.25        | 1.45  | 0.049  | 0.057 |

DOCUMENT NO.  
Z8B00003324

SCALE

7.5mm

EUROPEAN PROJECTION

ISSUE DATE  
30-08-2007

REVISION  
01



Figure A. Definition of switching times



Figure B. Definition of switching losses



Figure C. Definition of diodes switching characteristics

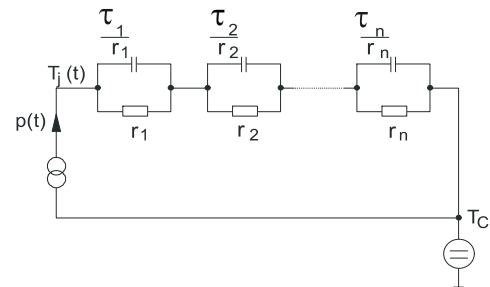

Figure D. Thermal equivalent circuit

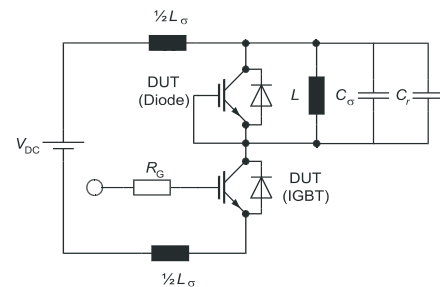

Figure E. Dynamic test circuit  
Parasitic inductance  $L_\sigma$ ,  
Parasitic capacitor  $C_\sigma$ ,  
Relief capacitor  $C_r$   
(only for ZVT switching)

**Revision History**

IGB20N60H3

**Revision: 2014-03-11, Rev. 2.3**

Previous Revision

| Revision | Date       | Subjects (major changes since last revision) |
|----------|------------|--|
| 1.1      | 2010-07-26 | Preliminary datasheet                        |
| 2.1      | 2013-12-09 | New value IRmax limit at 175°C               |
| 2.2      | 2014-02-26 | Without PB free logo                         |
| 2.3      | 2014-03-11 | Max ratings Vce, Tvj $\geq$ 25°C             |

**We Listen to Your Comments**

Any information within this document that you feel is wrong, unclear or missing at all ?

Your feedback will help us to continuously improve the quality of this document.

Please send your proposal (including a reference to this document) to: [erratum@infineon.com](mailto:erratum@infineon.com)

**Published by****Infineon Technologies AG****81726 Munich, Germany****81726 München, Germany****© 2014 Infineon Technologies AG****All Rights Reserved.****Legal Disclaimer**

The information given in this document shall in no event be regarded as a guarantee of conditions or characteristics.

With respect to any examples or hints given herein, any typical values stated herein and/or any information regarding the application of the device, Infineon Technologies hereby disclaims any and all warranties and liabilities of any kind, including without limitation, warranties of non-infringement of intellectual property rights of any third party.

**Information**

For further information on technology, delivery terms and conditions and prices, please contact the nearest Infineon Technologies Office ([www.infineon.com](http://www.infineon.com)).

**Warnings**

Due to technical requirements, components may contain dangerous substances. For information on the types in question, please contact the nearest Infineon Technologies Office.

The Infineon Technologies component described in this Data Sheet may be used in life-support devices or systems and/or automotive, aviation and aerospace applications or systems only with the express written approval of Infineon Technologies, if a failure of such components can reasonably be expected to cause the failure of that life-support, automotive, aviation and aerospace device or system or to affect the safety or effectiveness of that device or system. Life support devices or systems are intended to be implanted in the human body or to support and/or maintain and sustain and/or protect human life. If they fail, it is reasonable to assume that the health of the user or other persons may be endangered.