

# Solid State Relays 45mm, 3-Phase with Integrated Heatsink Types RGCM2, RGCM3



- 2-pole & 3-pole AC switching solid state contactors
- Product width 45mm
- Rated operational voltage: up to 600VAC
- Rated operational current: up to 20AAC
- Control voltages: 5-32VDC, 20-275VAC (24-190 VDC)
- Up to 1,800A<sup>2</sup>s for I<sup>2</sup>t
- Certified motor ratings up to 3HP / 3kW @ 400VAC
- Integrated varistor protection on output
- Enclosed heatsink
- UL, cUL Listing
- DIN or panel mount
- RoHS compliant

## Product Description

This product is intended to replace mechanical contactors especially when switching is frequent. The product width is 45mm and the heatsink is enclosed to provide a look alike to its mechanical counterpart. The enclosed heatsink eliminates the need for protective earth connection.

2-pole and 3-pole switching options are available. The

RGCM switches ON when the voltage crosses zero and switches OFF when the current crosses zero. Apart for resistive and slightly inductive loads, the RGCM is certified for motor switching with associated motor ratings.

Varistors are integrated for overvoltage protection. A green LED gives indication of control voltage presence.

Specifications are at a surrounding temperature of 25°C unless otherwise specified.

## Ordering Key **RGCM 3 A 60 D 15 G K E**

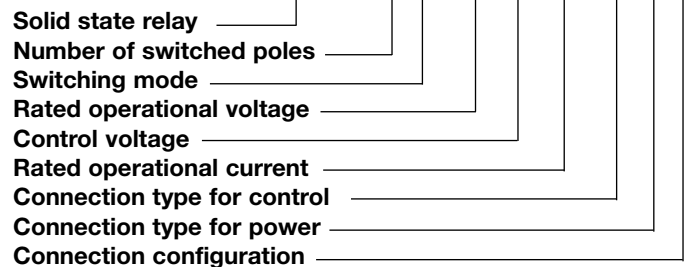

## Ordering Key

SSR with heatsink	Rated voltage, Blocking voltage	Control voltage	Rated current/pole @ 40°C <sup>1</sup>	Connection control	Connection power	Connection configuration
<b>RGCM2A:</b> 2-pole switching + 1-pole direct, ZC <sup>2</sup>	22: 42 - 242VAC, 800Vp  60: 42 - 660VAC, 1200Vp	D: 5 - 32VDC A: 20-275VAC, 24-190VDC	15: 15.5AAC 20: 20AAC	G: Pluggable box clamp	K: Screw	E: Contactor
<b>RGCM3A:</b> 3-pole switching, ZC <sup>2</sup>						

1. Refer to Derating Curves
2. ZC = Zero Cross Switching

## Selection Guide

Rated output voltage	Control voltage	Connection control	Connection power	Rated operational current @ 40°C (I <sup>2</sup> t value)	
				2-pole switching + 1-pole direct 20 AAC /pole (1800A <sup>2</sup> s)	3-pole switching 15.5 AAC /pole (1800A <sup>2</sup> s)
220VAC, ZC	5-32VDC	Box clamp	Screw	-	RGCM3A22D15GKE
	20-275VAC, 24-190VDC	Box clamp	Screw	-	RGCM3A22A15GKE
600VAC, ZC	5-32VDC	Box clamp	Screw	RGCM2A60D20GKE	RGCM3A60D15GKE
	20-275VAC, 24-190VDC	Box clamp	Screw	RGCM2A60A20GKE	RGCM3A60A15GKE

## General Specifications

Latching voltage (across L-T)	≤20V	Pollution degree	2 (non-conductive pollution with possibilities of condensation)
Operational frequency range	45 to 65Hz	Over-voltage category	III (fixed installations)
Power factor	> 0.5 @ Vrated	Isolation	4000Vrms 4000Vrms
CE marking	Yes	Input to Output	
Touch protection	IP20	Input & Output to Case	
Control input status	continuously ON Green LED, when control input is applied		

## Output Voltage Specifications

	RGCM2..20..	RGCM3..15..
Operational voltage range	42 - 220 VAC, +10%, -15% on max	42-600 VAC, +10% -15% on max
Blocking voltage	800Vp	1200 Vp
Internal varistor	275V	625V

## Output Specifications

	RGCM2..20..	RGCM3..15..
Rated operational current <sup>3</sup>		
AC-51 rating @ Ta=25°C	24.5 AAC	18 AAC
AC-51 rating @ Ta=40°C	20 AAC	15.5 AAC
AC-53a rating @ Ta=40°C	7.6 AAC	5.8 AAC
Number of motor starts (x:6, Tx:6s, F:50%) at 40°C <sup>4</sup>	30	30
Minimum operational current	250 mAAC	250 mAAC
Rep. overload current - (Motor Rating) PF = 0.4 - 0.5 UL508: T <sub>AMB</sub> =40°C, t <sub>ON</sub> =1s, t <sub>OFF</sub> =9s, 50cycles	50 AAC	40 AAC
Maximum transient surge current (I <sub>TSM</sub> ), t= 10ms	600 Ap	600 Ap
I <sup>2</sup> t for fusing (t=10ms)	1800 A <sup>2</sup> s	1800 A <sup>2</sup> s
Critical dv/dt (@ Tj init = 40°C)	1000 V/us	1000 V/us

3: Refer to Derating Curves

4: Overload cycle definition, x: multiple of AC-53a rating, Tx: duration of current surge, F: duty cycle

## Motor Ratings: HP (UL508) / kW (EN/IEC 60947-4-2) @ 40°C

	115 VAC	230 VAC	400 VAC	480 VAC	600 VAC
RGCM2..20	¾ HP / 0.56kW	2HP / 1.5kW	3HP / 3kW	5HP / 4kW	5HP / 5.5kW
RGCM3..15	½ HP / 0.37kW	1HP / 1.1kW	2HP / 2.2kW	3HP / 3kW	3HP / 4kW

## Input Specifications

	RG..D..	RG..A..
Control voltage range	5 - 32 VDC	20-275 VAC, 24 (-10%) - 190 VDC
Pick-up voltage	4.8 VDC	20 VAC/DC
Drop-out voltage	1 VDC	5 VAC/DC
Maximum reverse voltage	32 VDC	-
Maximum response time	0.5 cycle + 500µs @ 24VDC	2 cycles @ 230VAC/110VDC
Input current @ 40°C	See diagrams below	See diagrams below

### RG..D..

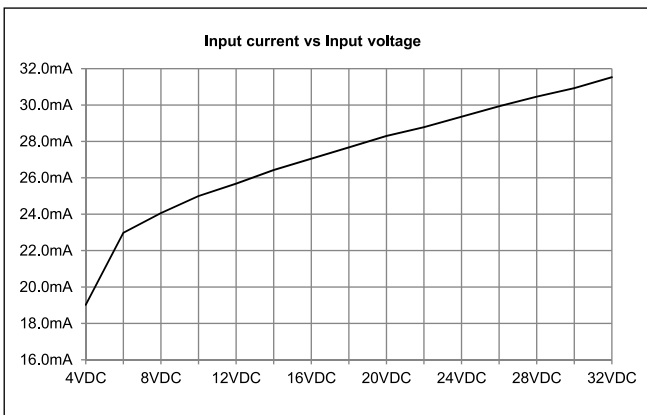

### RG..A..

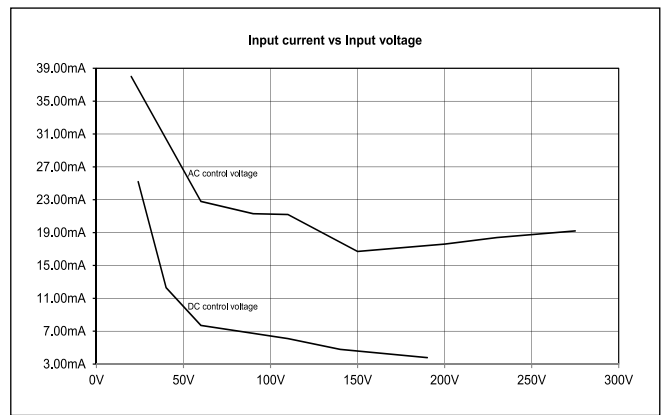

## Output Power Dissipation

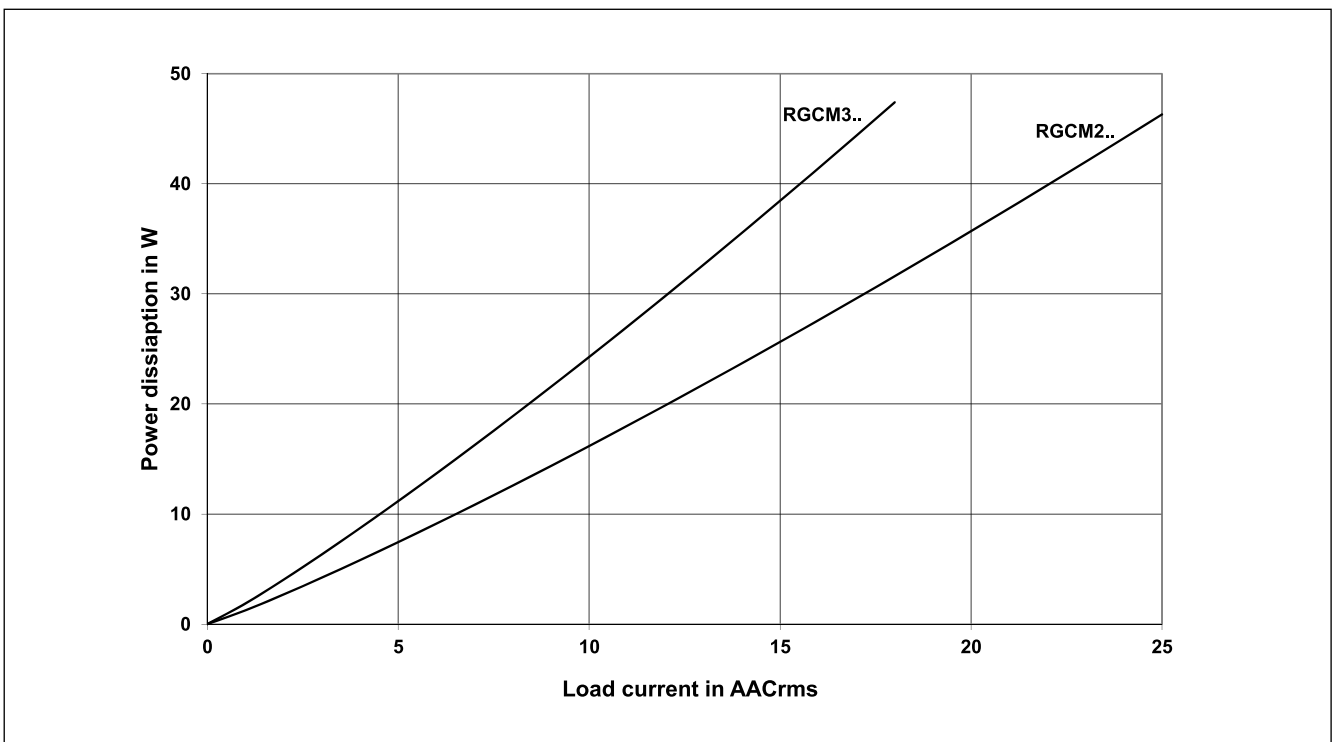

### Current Derating (UL508)

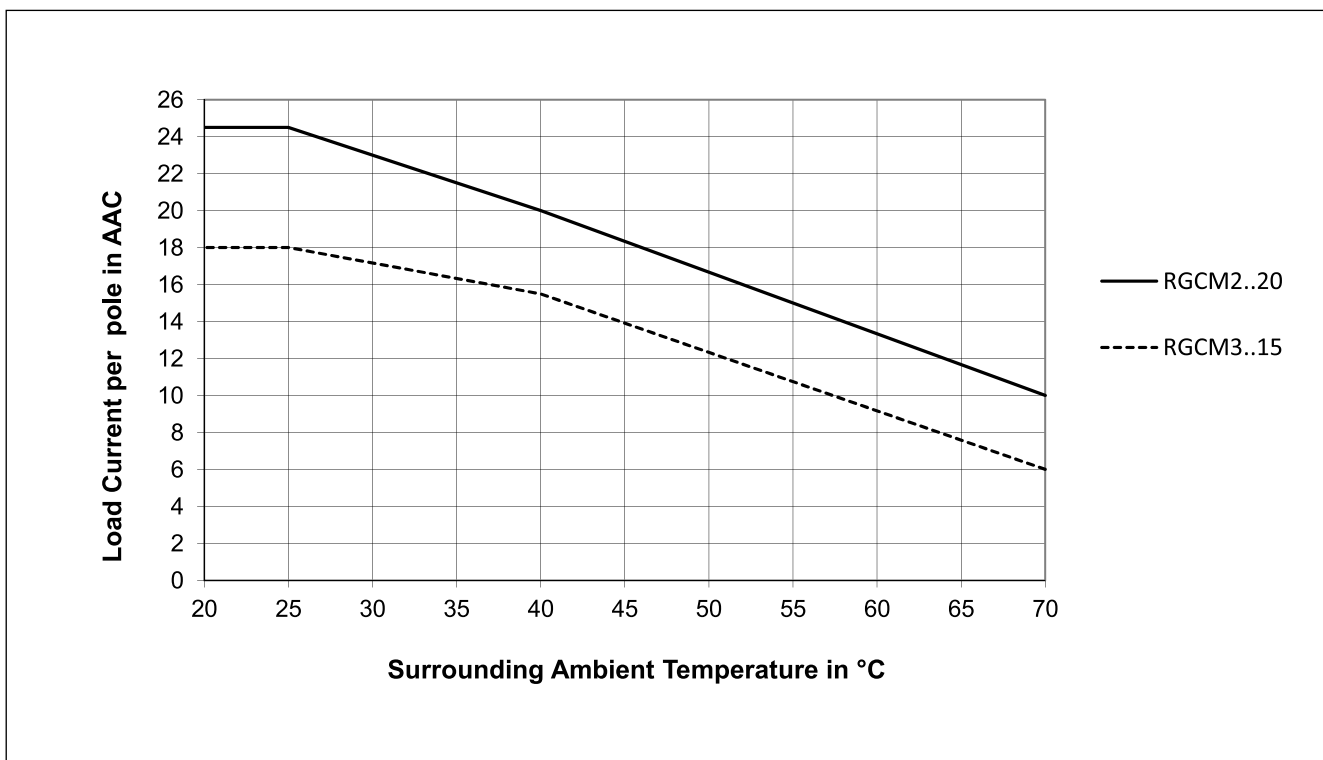

## Derating vs. Spacing Curves

RGCM2

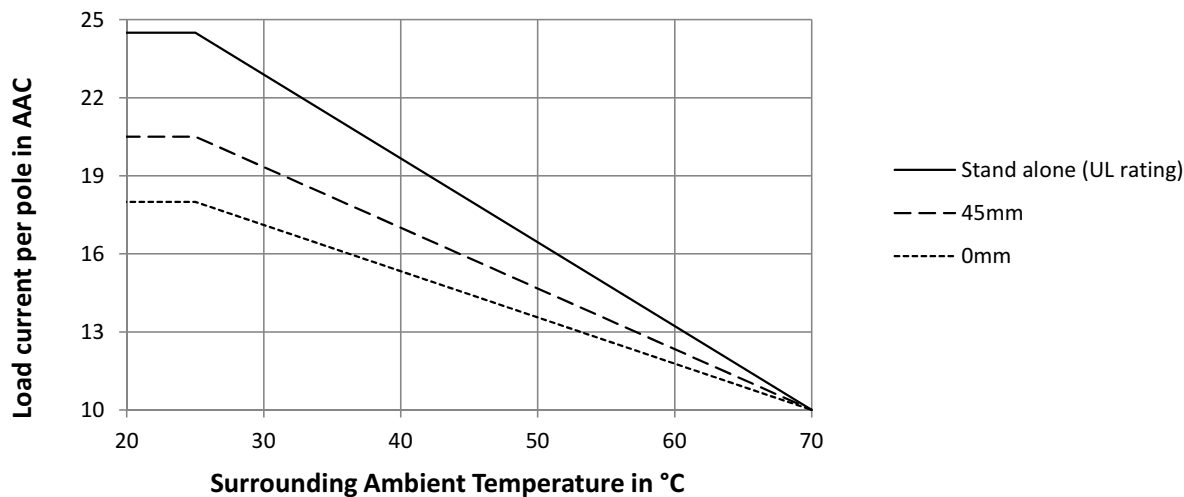

RGCM3

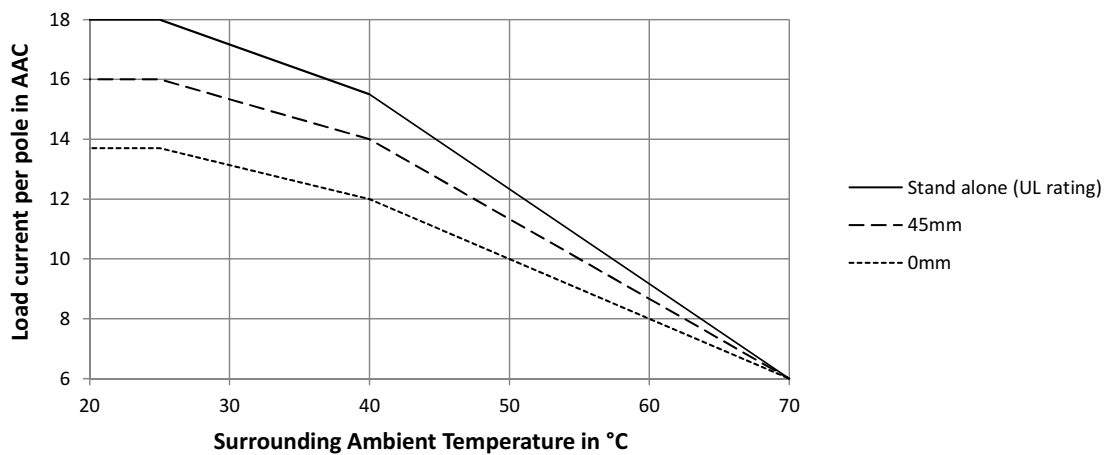

## Agency Approvals and Conformances

Conformance

EN/IEC 60947-4-2  
EN/IEC 60947-4-3

Agency Approvals

UL Listed (E172877), UL508  
cUL Listed (E172877), C22.2 No.14-10



## Electromagnetic Compatibility

<b>EMC Immunity</b>	EN/IEC 61000-6-2	<b>Radiated Radio Frequency Immunity</b>	EN/IEC 61000-4-3
<b>Electrostatic Discharge (ESD) Immunity</b> Air discharge, 8kV Contact, 4kV	EN/IEC 61000-4-2 Performance Criteria 2 Performance Criteria 2	10V/m, 80 - 1000 MHz 10V/m, 1.4 - 2 GHz 3V/m, 2 - 2.7 GHz	Performance Criteria 1 Performance Criteria 1 Performance Criteria 1
<b>Electrical Fast Transient (Burst) Immunity</b> Output: 2kV, 5kHz Input: 1kV, 5kHz	EN/IEC 61000-4-4 Performance Criteria 1 Performance Criteria 1	<b>Conducted Radio Frequency Immunity</b> 10V/m, 0.15 - 80 MHz	EN/IEC 61000-4-6 Performance Criteria 1
<b>Electrical Surge Immunity</b> Output, line to line, 1kV Output, line to earth, 2kV Input, line to line, 1kV Input, line to earth, 2kV	EN/IEC 61000-4-5 Performance Criteria 1 Performance Criteria 1 Performance Criteria 2 Performance Criteria 2	<b>Voltage Dips Immunity</b> 0% for 10ms/20ms, 40% for 200ms 70% for 500ms	EN/IEC 61000-4-11 Performance Criteria 2 Performance Criteria 2 Performance Criteria 2
<b>EMC Emission</b>	EN/IEC 61000-6-4	<b>Radio Interference Field Emission (Radiated)</b> 30 - 1000MHz	EN/IEC 55011 Class A (industrial)
<b>Radio Interference Voltage Emission (Conducted)</b> 0.15 - 30MHz	EN/IEC 55011 Class A (industrial) with filters - see filter information		

**Note:**

- Control input lines must be installed together to maintain products' susceptibility to Radio Frequency interference.
- Use of AC solid state relays may, according to the application and the load current, cause conducted radio interferences. Use of main filters may be necessary for cases where the user must meet E.M.C. requirements. The capacitor values given inside the filtering specification tables should be taken only as indications, the filter attenuation will depend on the final application.
- This product has been designed for Class A equipment. Use of this product in domestic environments may cause radio interference, in which case the user may be required to employ additional mitigation methods.
- Performance Criteria 1 (Performance Criteria A): No degradation of performance or loss of function is allowed when the product is operated as intended.
- Performance Criteria 2 (Performance Criteria B): During the test, degradation of performance or partial loss of function is allowed. However, when the test is complete the product should return operating as intended by itself.
- Performance Criteria 3 (Performance Criteria C): Temporary loss of function is allowed, provided the function can be restored by manual operation of the control.

## Filtering - EN / IEC 55011 Class A compliance

Part Number	Suggested filter for compliance	Maximum Heater current
RGCM2A22..20	220nF / 275V / X1	25A
RGCM2A60..20	220nF / 760V / X1	25A
RGCM3A22.15	220nF / 275V / X1	20A
RGCM3A60..15	220nF / 760V / X1	20A

## Filter Connection Diagrams

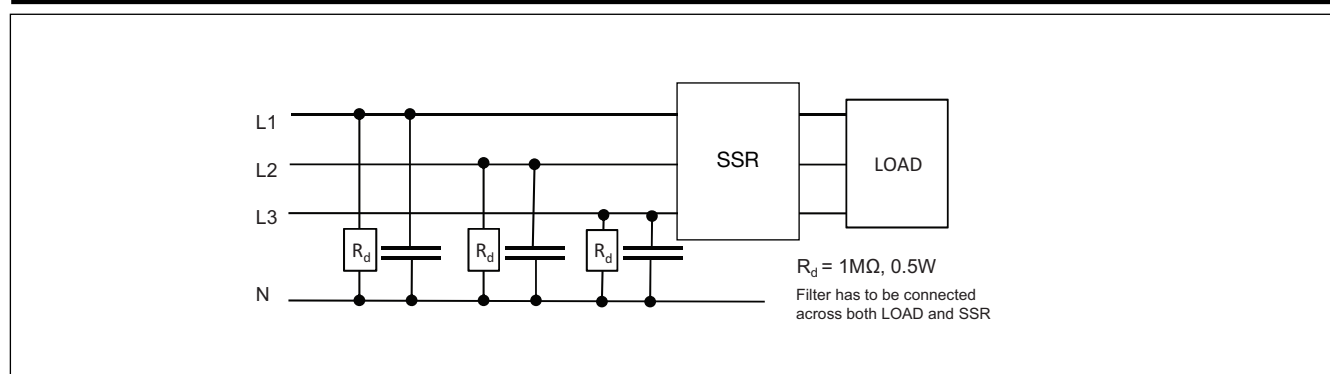

## Dimensions

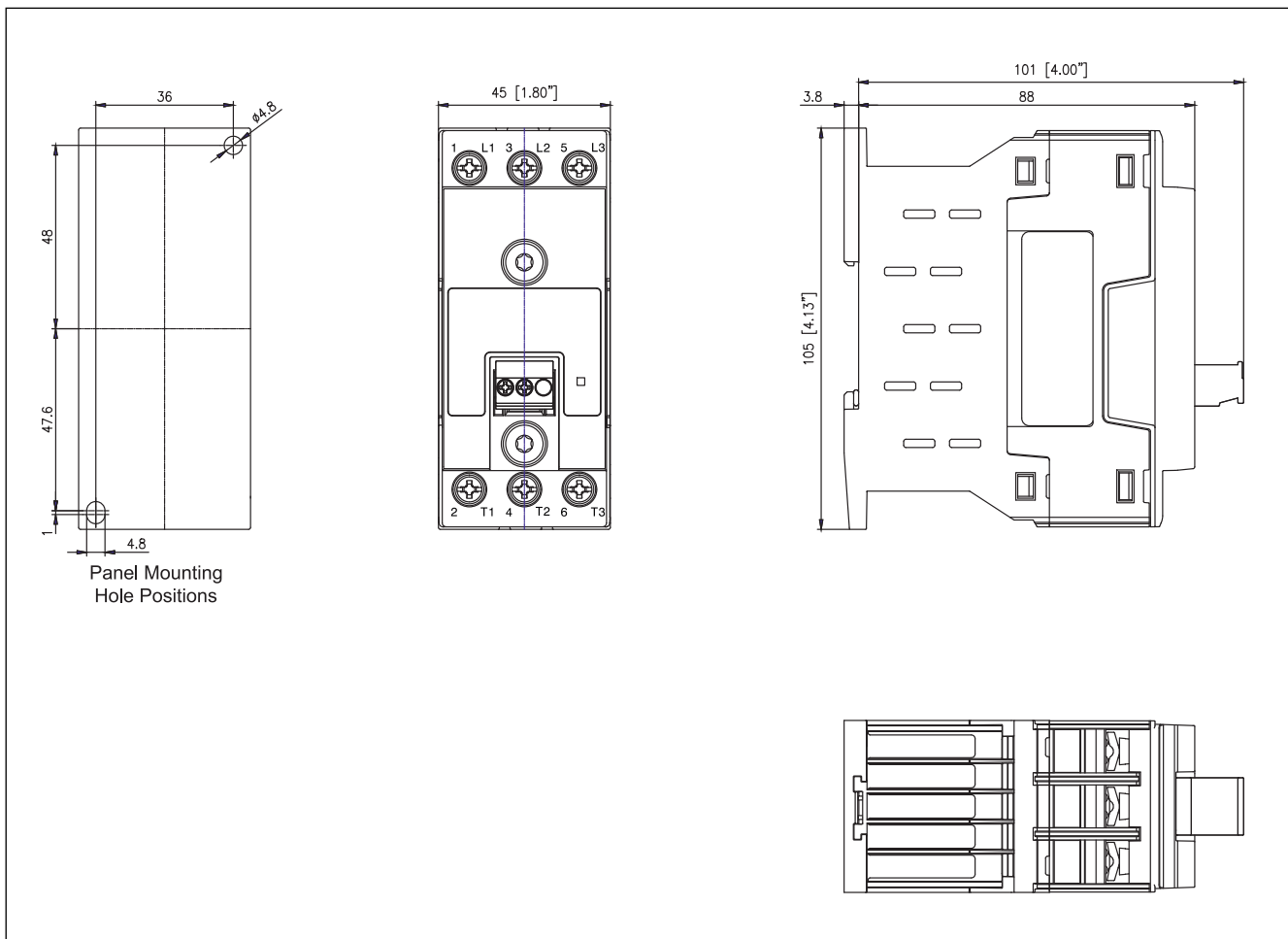

## Terminal Layout

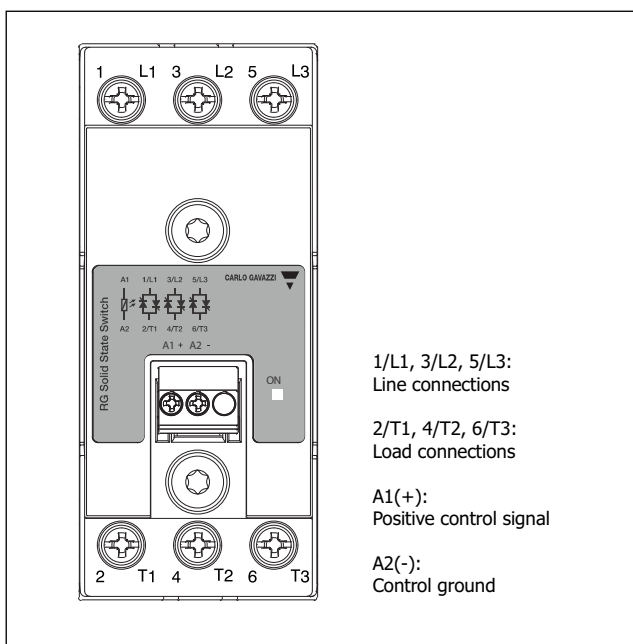

## Connection Specifications

### POWER CONNECTIONS

Use 75°C copper (Cu) conductors

1/L1, 3/L2, 5/L3, 2/T1, 4/T2, 6/T3

**Stripping Length (X)**

10mm

**Connection type**

M4 screw with captivated washer

**Rigid (Solid & Stranded)**

UL/ cUL rated data

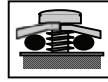
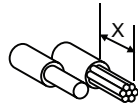

2 x 1.5.. 2.5mm<sup>2</sup>  
2 x 2.5 .. 6.0mm<sup>2</sup>  
2 x 16 .. 14 AWG  
2 x 14 .. 10 AWG

1 x 1.5.. 6mm<sup>2</sup>  
1 x 16 .. 10AWG

**Flexible with end sleeve**



2 x 1.5 ... 2.5mm<sup>2</sup>  
2 x 2.5..6.0mm<sup>2</sup>  
2 x 16.. 14 AWG  
2 x 14.. 10 AWG

1 x 1.5.. 6mm<sup>2</sup>  
1 x 16 .. 10AWG

**Flexible without end sleeve**



2 x 1.5 ... 2.5mm<sup>2</sup>  
2 x 2.5..6.0mm<sup>2</sup>  
2 x 16.. 14 AWG  
2 x 14.. 10 AWG

1 x 1.5.. 6mm<sup>2</sup>  
1 x 16 .. 10AWG

**Torque specifications**



2 Nm (17.7 in-lb)  
Pozidriv 2

**Aperture for termination lug**

11mm

### CONTROL CONNECTIONS

Use 60/75°C copper (Cu) conductors

A1(+), A2(-)

**Stripping Length (X)**

6 - 7.5mm

**Connection type**

Pluggable box clamp

**Rigid (Solid & Stranded)**

UL/ cUL rated data

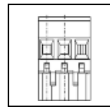
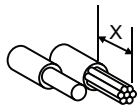

1x 0.2..2.5mm<sup>2</sup>  
1x 24...12 AWG

**Torque Specifications**



0.8Nm (7.0 lb-in),  
M3, Philips



## Connection Diagram

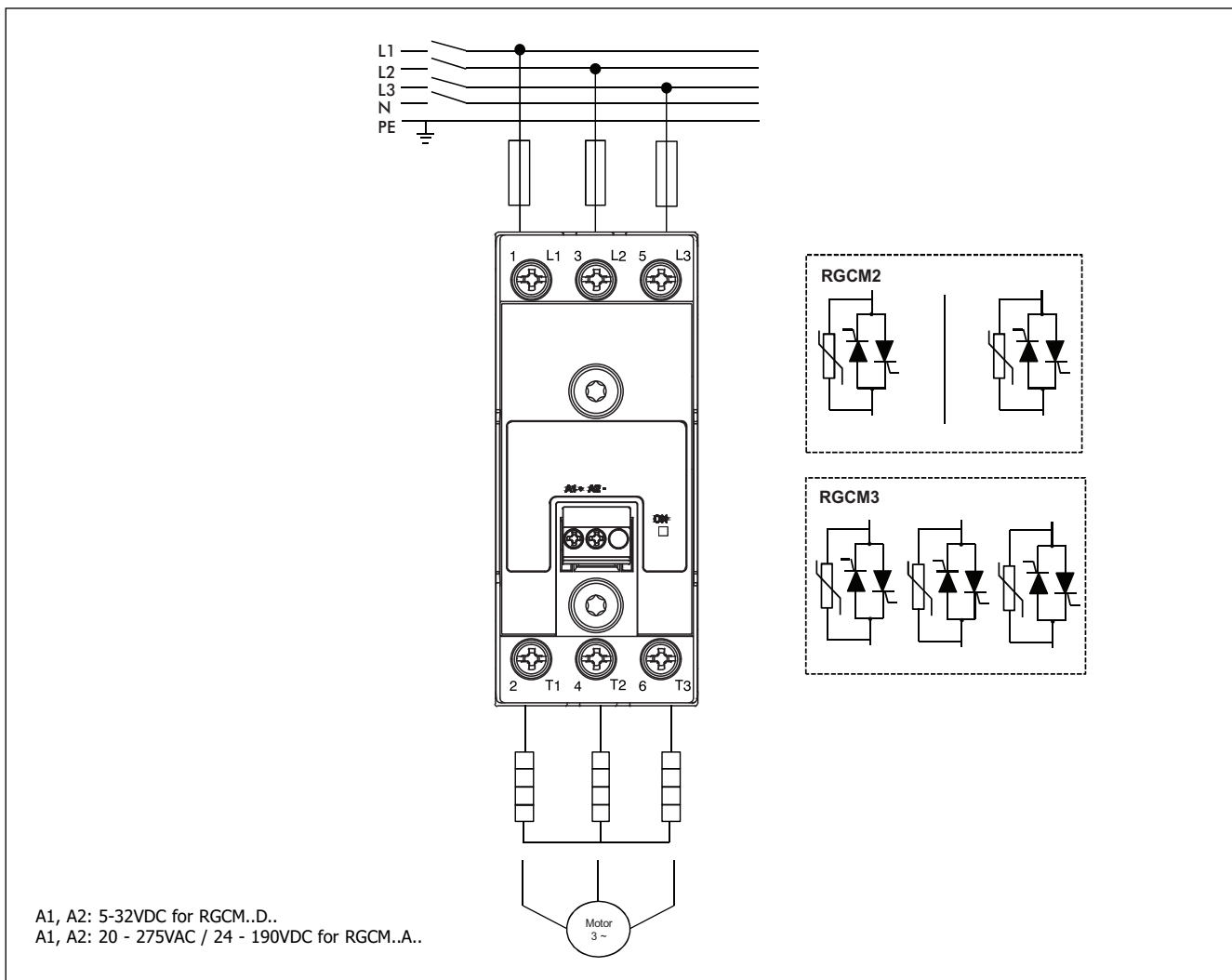

## Environmental Specifications

Operating Temperature	-40°C to 70°C (-40°F to +158°F)	Relative humidity	95% non-condensing @ 40°C
Storage Temperature	-40°C to 100°C (-40°F to +212°F)	UL flammability rating (housing)	UL 94 V0
RoHS (2002/95/EC)	Compliant	Installation Altitude	0 - 1000m. Above 1000m derate linearly by 1% of FLC per 100m up to a maximum of 2000m
Impact resistance (EN50155, EN61373)	15/11 g/ms	Weight	400g
Vibration resistance (2-100Hz, IEC60068-2-26, EN50155, EN61373)	2g per axis		

## Installation Instructions

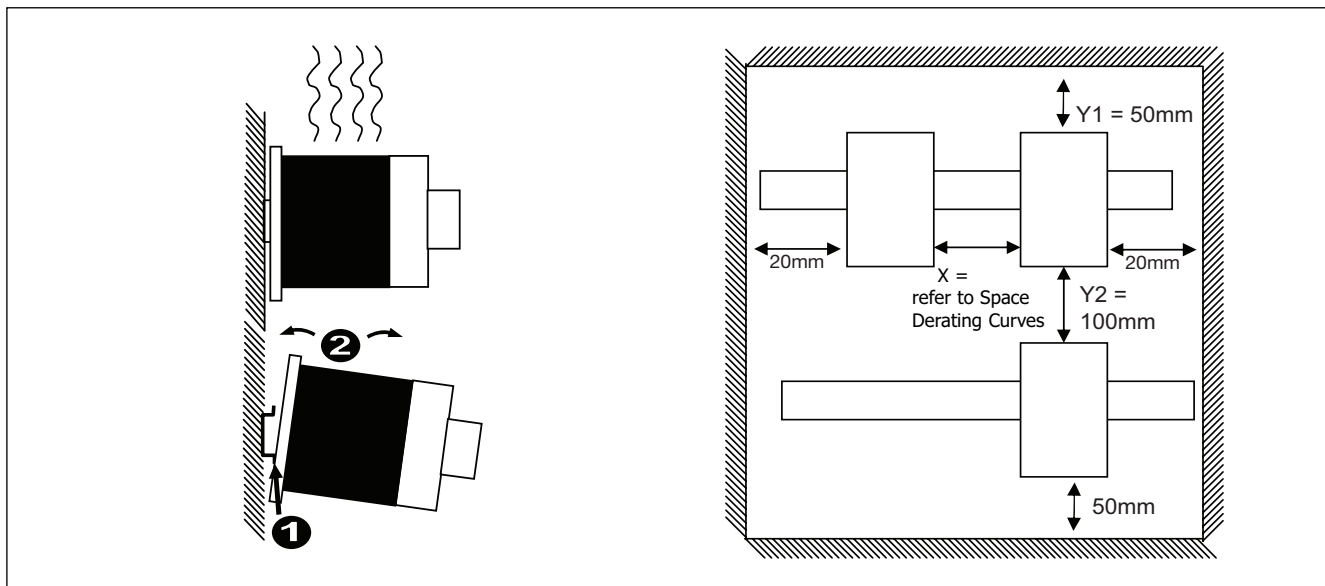

1. Push spring upwards against DIN rail. When spring is under pressure, clip device on to the DIN rail
2. Push spring upwards against DIN rail. When spring is under pressure, remove device from DIN rail
3. Mount the cooling fins vertically

## Short Circuit Protection

### Protection Co-ordination, Type 1 vs Type 2:

Type 1 protection implies that after a short circuit, the device under test will no longer be in a functioning state. In type 2 co-ordination the device under test will still be functional after the short circuit. In both cases, however the short circuit has to be interrupted. The fuse between enclosure and supply shall not open. The door or cover of the enclosure shall not be blown open. There shall be no damage to conductors or terminals and the conductors shall not separate from terminals. There shall be no breakage or cracking of insulating bases to the extent that the integrity of the mounting of live parts is impaired. Discharge of parts or any risk of fire shall not occur.

The product variants listed in the table hereunder are suitable for use on a circuit capable of delivering not more than 5,000A rms Symmetrical Amperes, 600 Volts maximum when protected by fuses. Tests at 5,000A were performed with Class RK5 fuses; please refer to table below for maximum allowed ampere rating of the fuse. Use fuses only.

Tests with class RK5 fuses represent class CC fuses.

### Co-ordination type 1 (UL508)

Part No.	Max. fuse size [A]	Class	Short circuit current [kArms]	Voltage [VAC]
RGCM2..20	25 25	RK5 CC	5	Max. 600
RGCM3..15	25 25	RK5 CC	5	Max. 600

### Co-ordination type 2 (EN/IEC 60947-4-2/ -4-3)

Part No.	Ferraz Shawmut		Short circuit current [kArms]	Voltage [VAC]
	Fuse size [A]	Part Number		
RGCM2..20	32	6.9xx CP gRC 14x51/32	5	Max. 600
RGCM3..15	25	6.9xx CP gRC 14x51/25	5	Max. 600

## Type 2 Protection with Miniature Circuit Breakers

Solid State Relay type	ABB Model no. for Z - type M. C. B. (rated current)	ABB Model no. for B - type M. C. B. (rated current)	Wire cross sectional area [mm <sup>2</sup> ]	Minimum length of Cu wire conductor [m] <sup>5</sup>
RGM2..20 RGM3..15	S201 - Z10 (10A)	S201-B4 (4A)	1.0	7.6
			1.5	11.4
			2.5	19.0
	S201 - Z16 (16A)	S201-B6 (6A)	1.0	5.2
			1.5	7.8
			2.5	13.0
			4.0	20.8
	S201 - Z20 (20A)	S201-B10 (10A)	1.5	12.6
			2.5	21.0
	S201 - Z25 (25A)	S201-B13 (13A)	2.5	25.0
			4.0	40.0

5: Between MCB and Load (including return path which goes back to the mains if applicable).

Note: A prospective current of 6kA and a 230/400V power supply system is assumed for the above suggested specifications. For cables with different cross section than those mentioned above please consult Carlo Gavazzi's Technical Support Group.

## Accessories

### Motor Overload Relay Adaptor

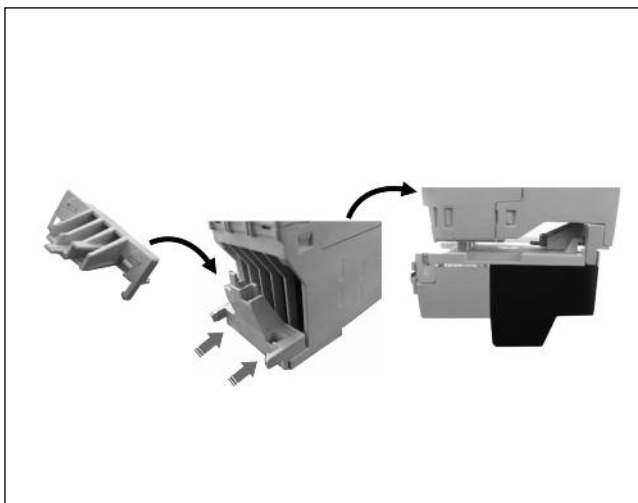

### Ordering Key

Overload relay adaptor

**REC3ADAPTOR**

This plastic adaptor can be fitted to the RGCM housing cover to facilitate mounting of overload protection relays. This adaptor is compatible with:

Manufacturer	Series	Example
ABB	TA	TA25DU-8.5
Siemens	3RU11	3RU1126-1FB0

REC3ADAPTOR packing quantity is 5 pcs.

### Control Plugs

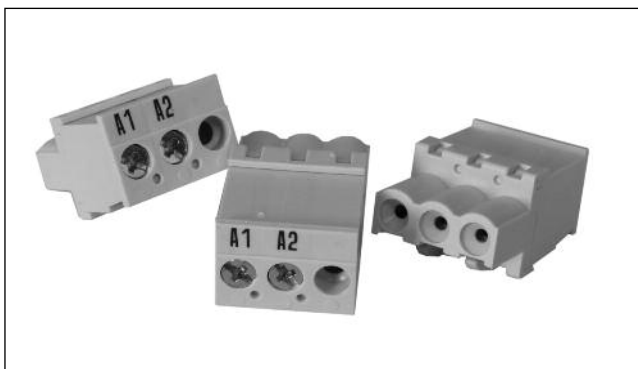

### Ordering Key

Pack of 10 box clamp control plugs

**RG3G25**

\* Refer to 'Connection Specifications' section for further details.