

V <sub>RSM</sub>	V <sub>RDM</sub>	(dv/dt) <sub>cr</sub>	I <sub>TRMS</sub> (maximum value for continuous operation)			
			220 A	250 A	220 A	250 A
V	V	V/μs	I <sub>TAV</sub> (sin. 180; T <sub>case</sub> = 80 °C)			
			148 A	168 A	148 A	168 A
			<b>SKKT</b>	<b>SKKT</b>	<b>SKKH</b>	<b>SKKH</b>
900	800	500	<b>132/08 D</b>	<b>162/08 D</b>	<b>132/08 D</b>	<b>162/08 D</b>
1300	1200	1000	<b>132/12 E</b>	<b>162/12 E</b>	<b>132/12 E</b>	<b>162/12 E</b>
1500	1400	1000	<b>132/14 E</b>	<b>162/14 E</b>	<b>132/14 E</b>	<b>162/14 E</b>
1700	1600	1000	<b>132/16 E</b>	<b>162/16 E</b>	<b>132/16 E</b>	<b>162/16 E</b>
1900	1800	1000	<b>132/18 E</b>	<b>162/18 E</b>	<b>132/18 E</b>	<b>162/18 E</b>
2100	2000	1000	<b>132/20 E</b>	–	<b>132/20 E</b>	–
2300	2200	1000	<b>132/22 E</b>	–	<b>132/22 E</b>	–

## SEMIPACK® 2 Thyristor / Diode Modules

**SKKT 132**      **SKKH 132**  
**SKMT 132<sup>1)</sup>**      **SKNH 132<sup>1)</sup>**  
**SKKT 162**      **SKKH 162**



Symbol	Conditions	SKKT 132 SKKH 132	SKKT 162 SKKH 162	Units	
I <sub>TAV</sub>	sin. 180; (T <sub>case</sub> = . . .)	130 (87 °C)	160 (83 °C)	A	
I <sub>D</sub>	B2/B6   T <sub>amb</sub> = 45 °C; P 3/180	77 / 100	–	A	
		T <sub>amb</sub> = 35 °C; P 3/180 F	170 / 200	190 / 230	A
I <sub>RMS</sub>	W1/W3   P 16/200 F	250 / 320	290 / 360	A	
		P 3/180 F	240 / 3 x 163	265 / 3 x 185	A
		P 16/200 F	305 / 3 x 250	333 / 3 x 312	A
I <sub>TSM</sub>	T <sub>vj</sub> = 25 °C; 10 ms	4 700	5 400	A	
	T <sub>vj</sub> = 125 °C; 10 ms	4 000	5 000	A	
i <sup>2</sup> t	T <sub>vj</sub> = 25 °C; 8,3 ... 10 ms	110 000	145 000	A <sup>2</sup> s	
	T <sub>vj</sub> = 125 °C; 8,3 ... 10 ms	80 000	125 000	A <sup>2</sup> s	
t <sub>gd</sub>	T <sub>vj</sub> = 25 °C; I <sub>G</sub> = 1 A di <sub>G</sub> /dt = 1 A/μs	1		μs	
t <sub>gr</sub>	V <sub>D</sub> = 0,67 · V <sub>DRM</sub>	2		μs	
(di/dt) <sub>cr</sub>	T <sub>vj</sub> = 125 °C	200		A/μs	
t <sub>q</sub>	T <sub>vj</sub> = 125 °C	typ. 50 . . . 150		μs	
I <sub>H</sub>	T <sub>vj</sub> = 25 °C; typ./max.	150 / 400		mA	
I <sub>L</sub>	T <sub>vj</sub> = 25 °C; R <sub>G</sub> = 33 Ω; typ./max.	0,3 / 1		A	
V <sub>T</sub>	T <sub>vj</sub> = 25 °C; I <sub>T</sub> = 500 A	max. 1,8	max. 1,6	V	
V <sub>T(TO)</sub>	T <sub>vj</sub> = 125 °C	1	0,85	V	
r <sub>T</sub>	T <sub>vj</sub> = 125 °C	1,6	1,5	mΩ	
I <sub>DD</sub> ; I <sub>RD</sub>	T <sub>vj</sub> = 125 °C; V <sub>DRM</sub> ; V <sub>RDM</sub>	max. 40	max. 40	mA	
V <sub>GT</sub>	T <sub>vj</sub> = 25 °C; d.c.	2		V	
I <sub>GT</sub>	T <sub>vj</sub> = 25 °C; d.c.	150		mA	
V <sub>GD</sub>	T <sub>vj</sub> = 125 °C; d.c.	0,25		V	
I <sub>GD</sub>	T <sub>vj</sub> = 125 °C; d.c.	10		mA	
R <sub>thjc</sub> R <sub>thch</sub> T <sub>vj</sub> , T <sub>stg</sub>	cont. } per thyristor / sin. 180 } per module rec. 120 }	0,18 / 0,09	0,17 / 0,085	°C/W	
		0,19 / 0,095	0,18 / 0,09	°C/W	
		0,21 / 0,105	0,20 / 0,10	°C/W	
		0,10 / 0,05		°C/W	
– 40 ... + 125		°C			
V <sub>isol</sub>	a. c. 50 Hz; r.m.s.; 1 s/1 min	3600 / 3000		V~	
M <sub>1</sub>	to heatsink } SI (US) units to terminals }	5 (44 lb. in.) ± 15 % <sup>2)</sup>		Nm	
M <sub>2</sub>		5 (44 lb. in.) ± 15 %		Nm	
a		5 · 9,81		m/s <sup>2</sup>	
w	approx.	250		g	
Case	→ page B 1 – 96	SKKT: A 21	SKMT: A 50		
		SKKH: A 22	SKNH: A 61		

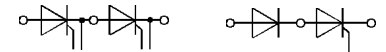

**SKKT**

**SKKH**

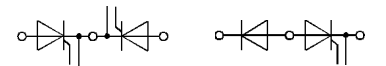

**SKMT**

**SKNH**

### Features

- Heat transfer through aluminium oxide ceramic isolated metal baseplate
- Hard soldered joints for high reliability
- UL recognized, file no. E 63 532

### Typical Applications

- DC motor control (e.g. for machine tools)
- Temperature control (e.g. for ovens, chemical processes)
- Professional light dimming (studios, theaters)
- SKNH 162 for DC braking of induction motors, for circuit see page B 1 – 97

<sup>1)</sup> SKMT 132, SKNH 132 available on request

<sup>2)</sup> See the assembly instructions

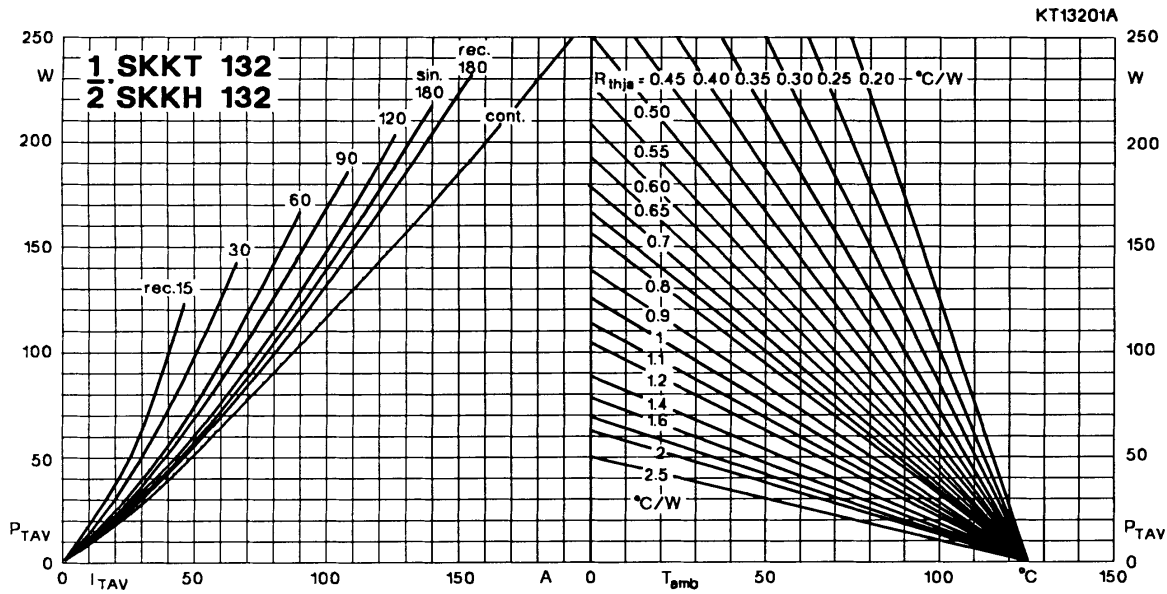

Fig. 1 a Power dissipation per thyristor vs. on-state current and ambient temperature

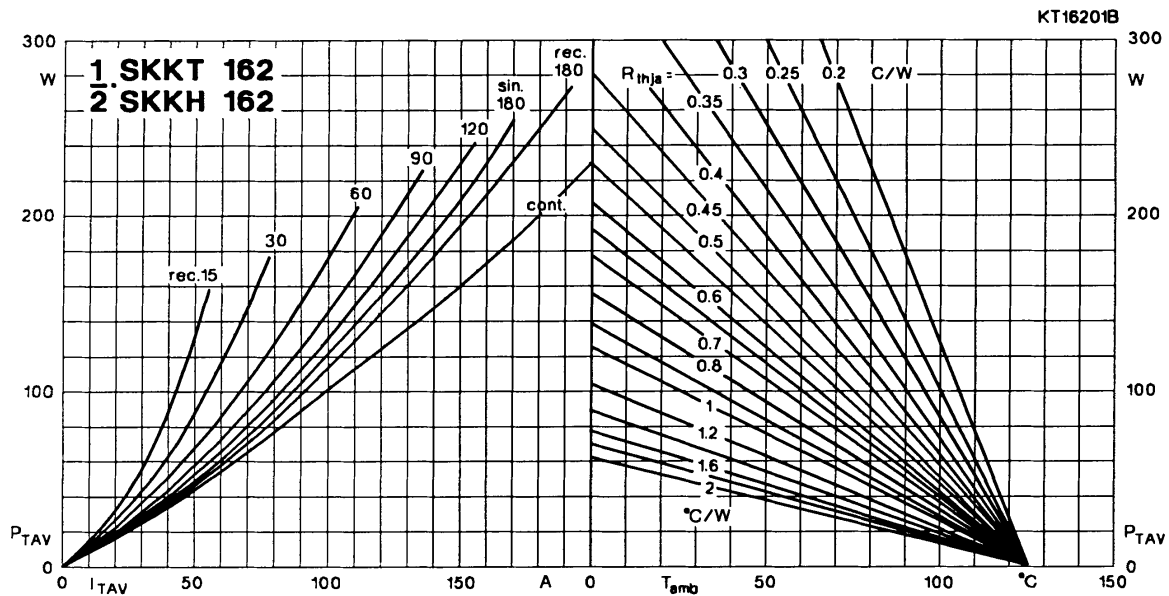

Fig. 1 b Power dissipation per thyristor vs. on-state current and ambient temperature

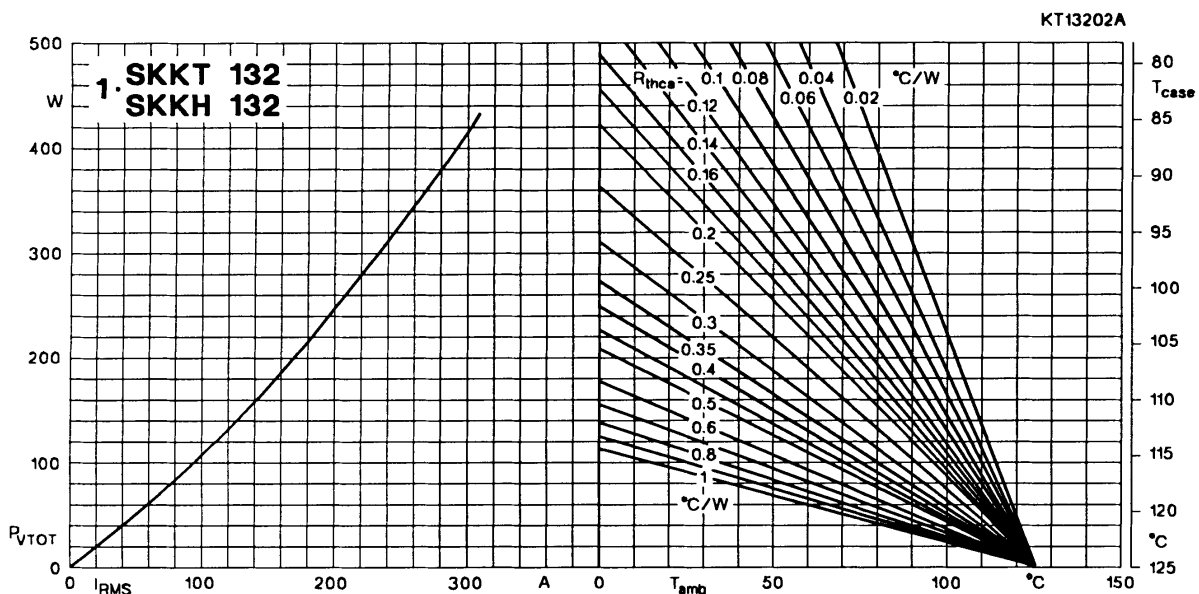

Fig. 2 a Power dissipation per module vs. rms current and case temperature

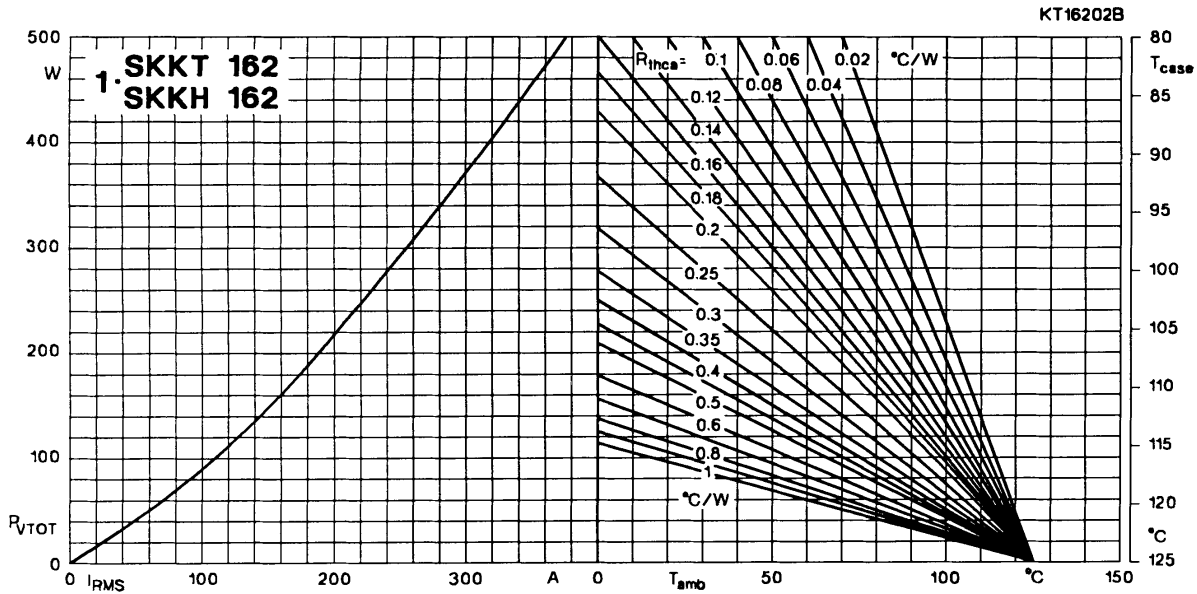

Fig. 2 b Power dissipation per module vs. rms current and case temperature

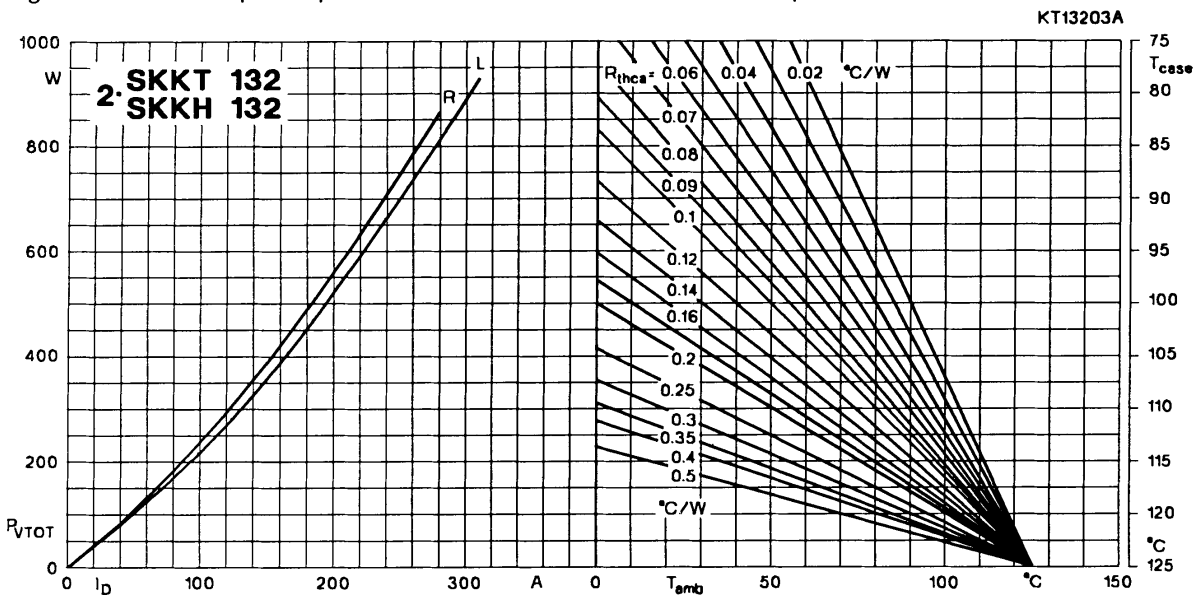

Fig. 3 a Power dissipation of two modules vs. direct current and case temperature

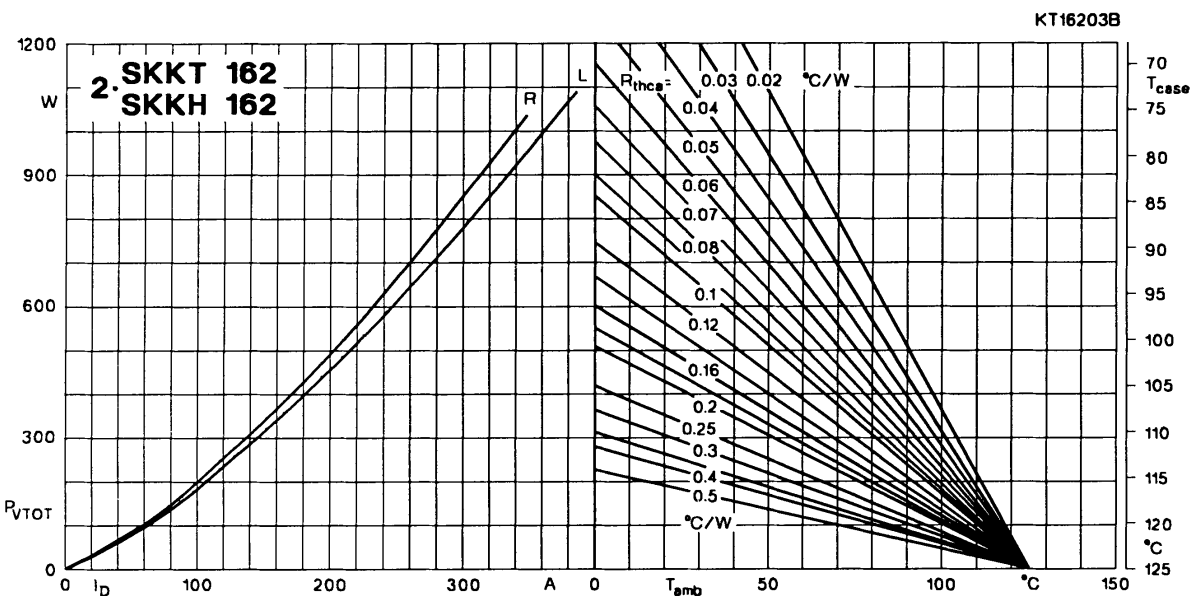

Fig. 3 b Power dissipation of two modules vs. direct current and case temperature

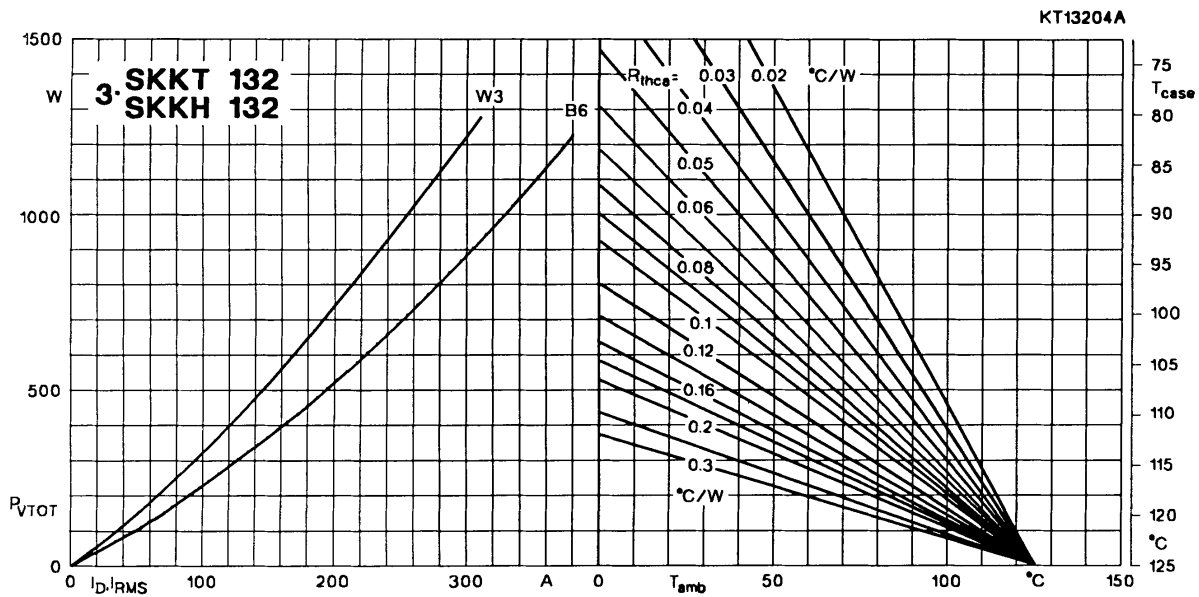

Fig. 4 a Power dissipation of three modules vs. direct and rms current and case temperature

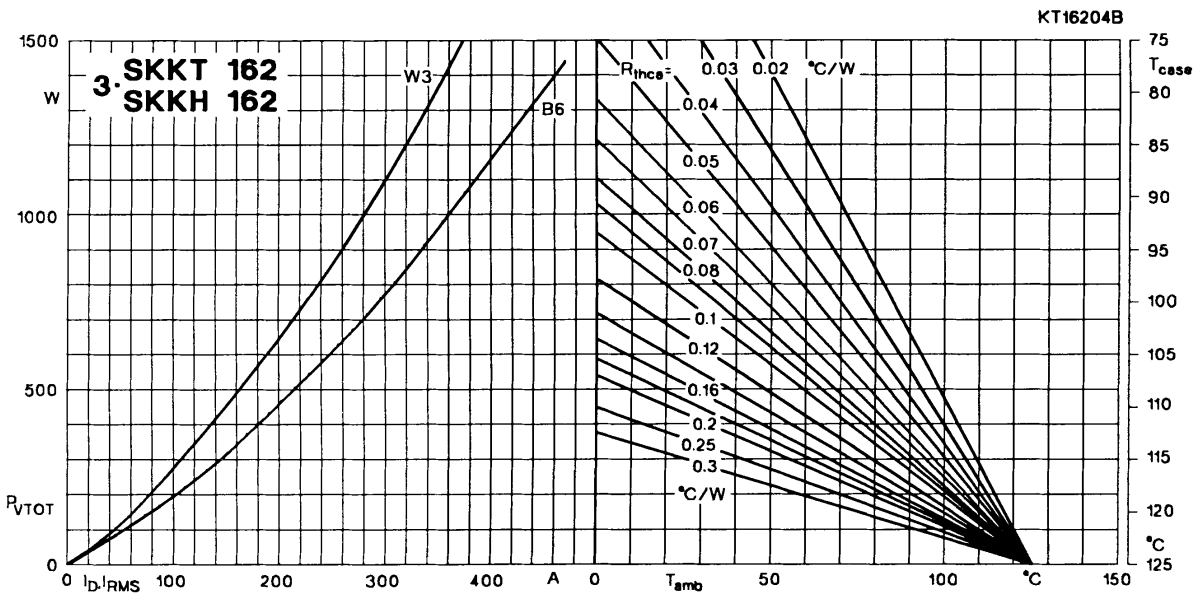

Fig. 4 b Power dissipation of three modules vs. direct and rms current and case temperature

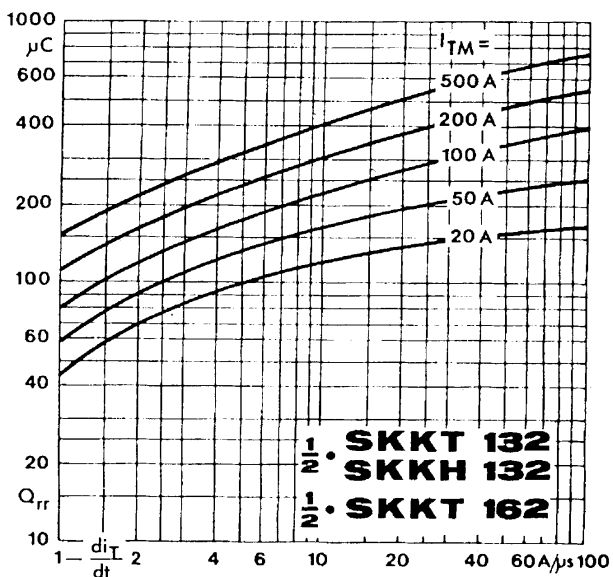

Fig. 5 Recovered charge vs. current decrease

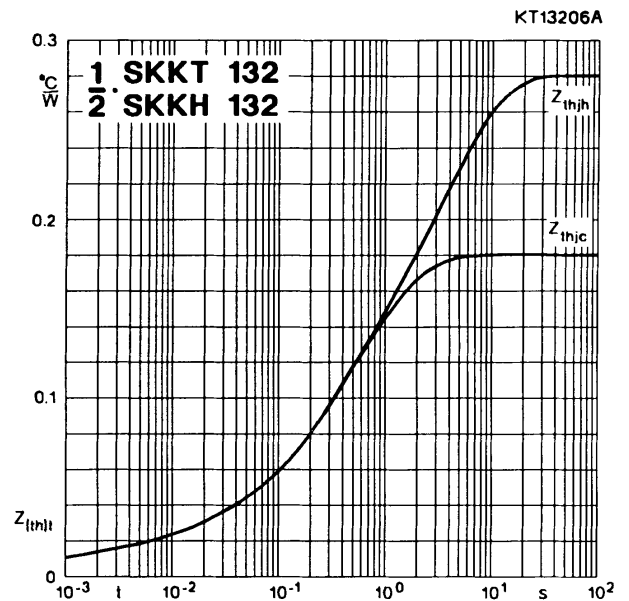

Fig. 6 a Transient thermal impedance vs. time

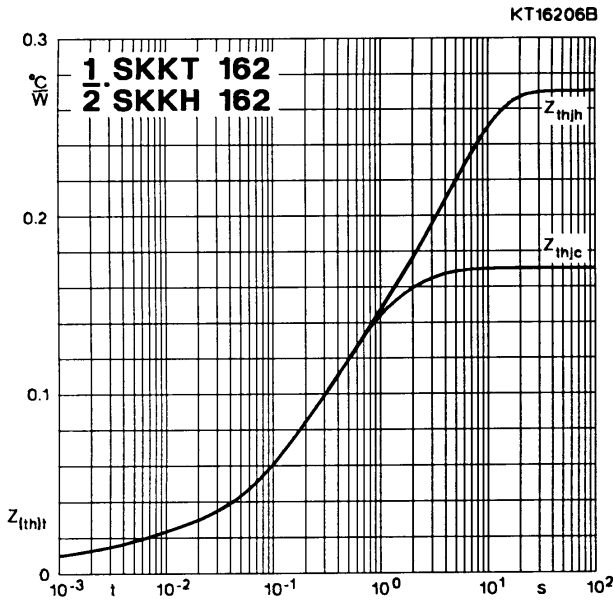

Fig. 6 b Transient thermal impedance vs. time

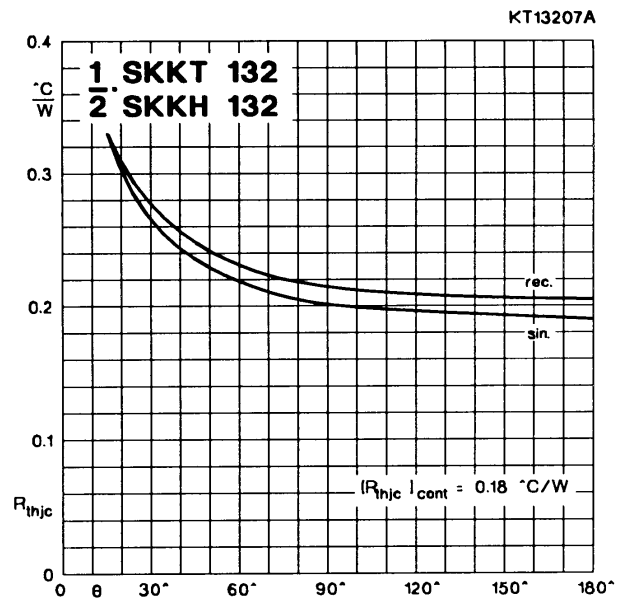

Fig. 7 a Thermal resistance vs. conduction angle

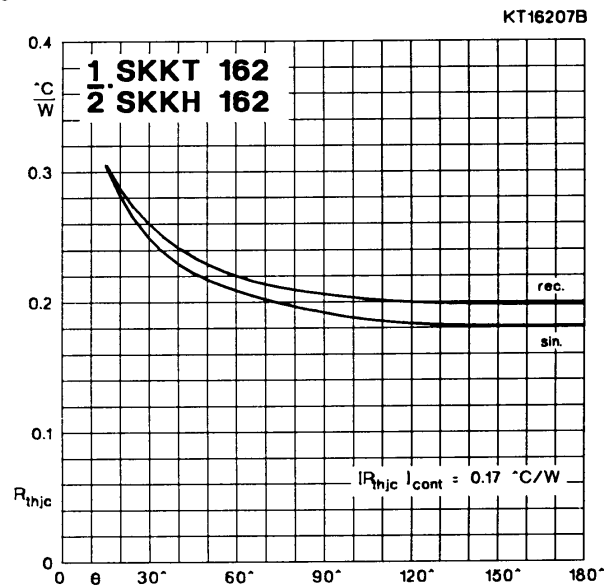

Fig. 7 b Thermal resistance vs. conduction angle

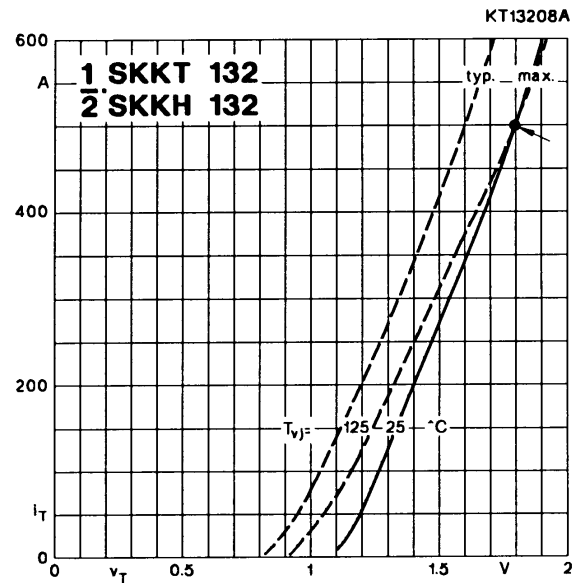

Fig. 8 a On-state characteristics

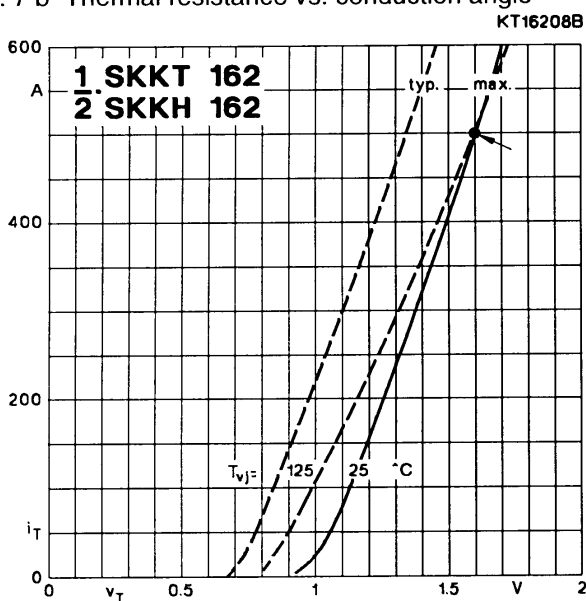

Fig. 8 b On-state characteristics

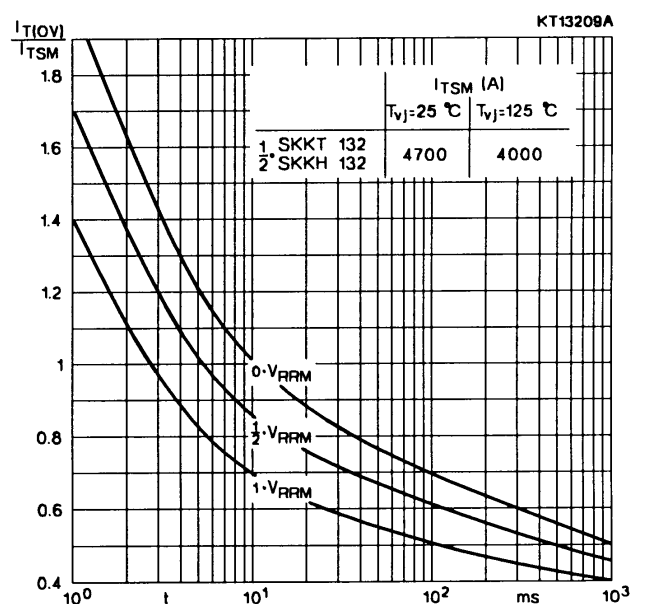

Fig. 9 a Surge overload current vs. time

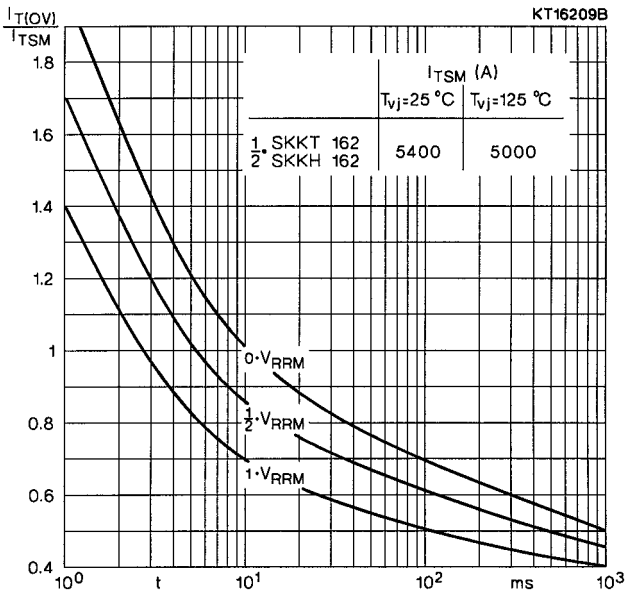

Fig. 9 b Surge overload current vs. time

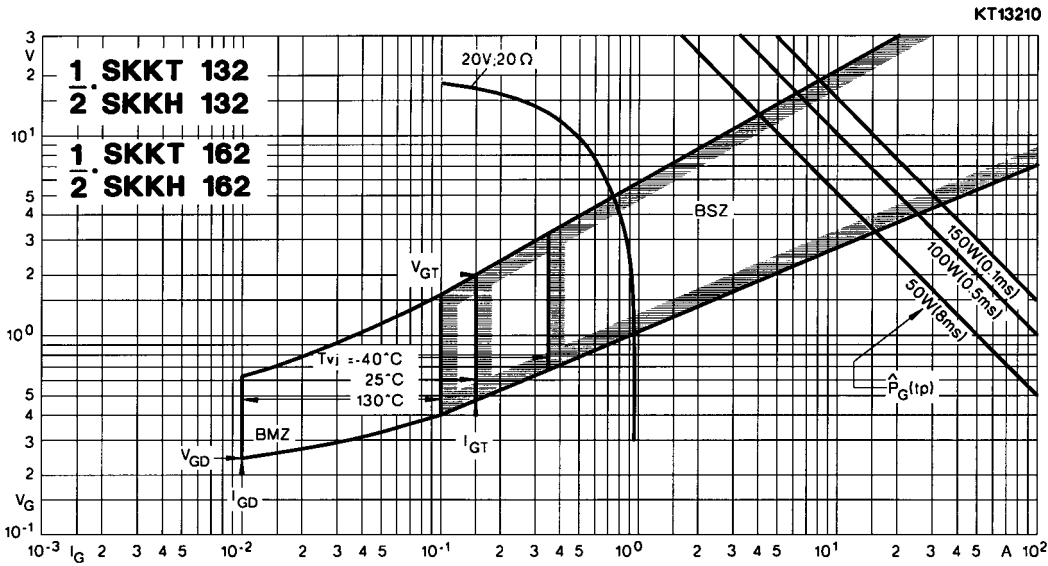
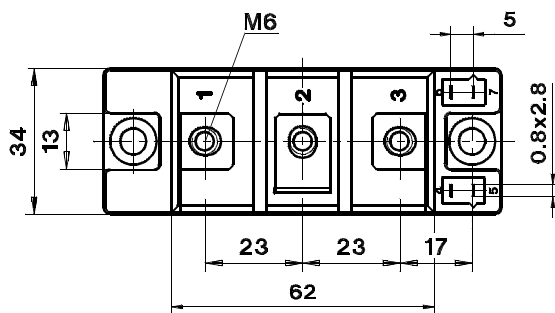
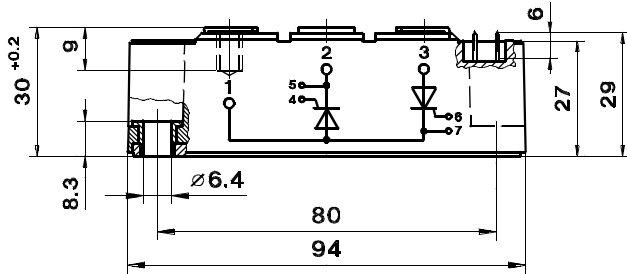

Fig. 10 Gate trigger characteristics

**SKKT 122, 132, 162**

Case A 21

SEMIPACK® 2 UL recognized, file no. E 63 532

**SKMT 132**

Case A 50

SEMIPACK® 2 UL recognized, file no. E 63 532

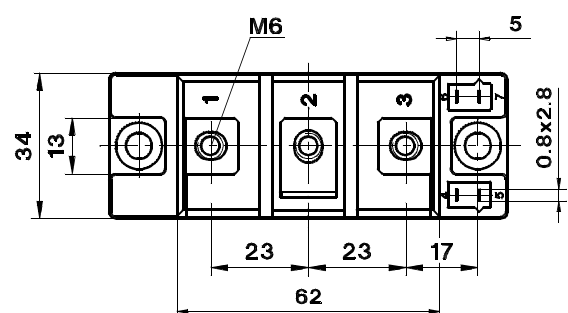
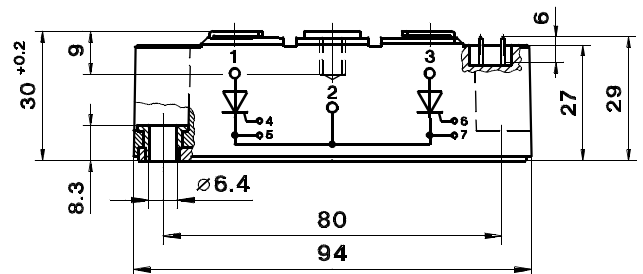
**SKKH 122, 132, 162**

Case A 22

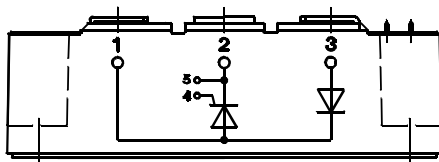
**SKND 165**

Case A 52

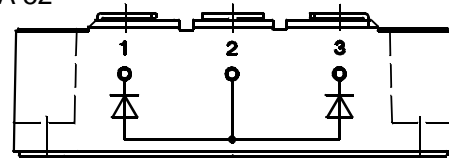
**SKKD 162**

Case A 23

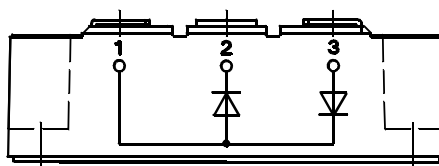
**SKND 162**

Case A 57

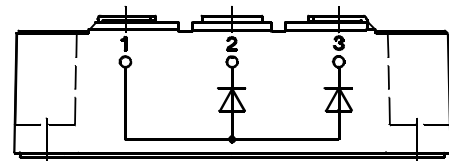
**SKKE 162**

Case A 24

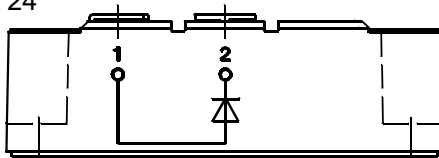

Dimensions in mm

**SKNH 132**

Case A 61

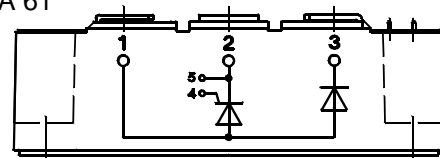

Dimensions in mm