

AK500/..DS-5.0-V-GRAU

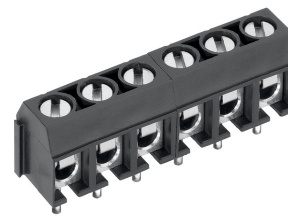





A Phoenix Mecano Brand

Technische Daten

Anschlussquerschnitte		Isolierstoff	
eindrähtig (starr) min	0.2 mm ²	Material	PA 6.6
eindrähtig (starr) max	1.5 mm ²	Brennbarkeitsklasse	UL 94 V-0
feindrähtig (flexibel) min	0.2mm ²	Temperaturen	
feindrähtig (flexibel) max	1.5 mm ²	Arbeitstemperatur	-30 °C - 105 °C
feindrähtig (mit Aderendhülse) min	0.2 mm ²	Lagertemperatur	-40 °C - 105 °C
feindrähtig (mit Aderendhülse) max	1.5 mm ²	Wellenlötverfahren	
Maße		Löttemperatur, empfohlen	260 °C
Absolierlänge	6.0 mm	Peaklötdauer, empfohlen	3-4 s
Bohrlochdurchmesser	1.3 mm	Reflowprozess	
Werkstoffe		Löttemperatur, empfohlen	-
Klemmstück	Messing	Peaklötdauer, empfohlen	-
Drahtschutz	Edelstahl		
Schraube	Stahl		

Farben

	GRAU, RAL 7016
	SCHWARZ, RAL 9011
	GRÜN, RAL 6018
	BLAU, RAL 5015

Farben nach RAL, Farbabweichungen sind produktionsbedingt. Sonderfarben sind möglich.

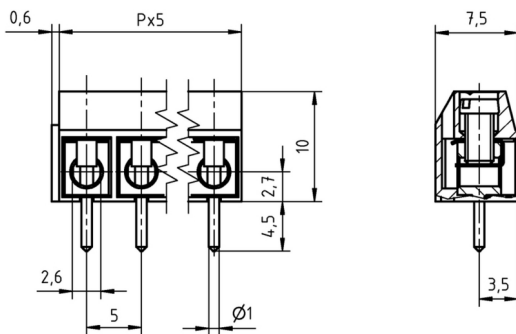

Bestelldaten (Rastermaß 5.0 mm)



Polzahl	Breite (mm)	Artikelbezeichnung	Artikelnummer	VPE
2	10.60	AK500/2DS-5.0-V-GRAU	50500020121 G	250
3	15.60	AK500/3DS-5.0-V-GRAU	50500030121 G	250
4	20.60	AK500/4DS-5.0-V-GRAU	50500040121 G	250
5	25.60	AK500/5DS-5.0-V-GRAU	50500050121 G	250
6	30.60	AK500/6DS-5.0-V-GRAU	50500060121 G	250
7	35.60	AK500/7DS-5.0-V-GRAU	50500070121 G	250
8	40.60	AK500/8DS-5.0-V-GRAU	50500080121 E	100
9	45.60	AK500/9DS-5.0-V-GRAU	50500090121 E	100
10	50.60	AK500/10DS-5.0-V-GRAU	50500100121 E	100
11	55.60	AK500/11DS-5.0-V-GRAU	50500110121 E	100
12	60.60	AK500/12DS-5.0-V-GRAU	50500120121 E	100

Zubehör

Abbildung	Bezeichnung	Artikelnummer
	Brücke, 2 polig, isoliert, BRI/2-5.0/5.08-LICHTGRAU	Art.-Nr. 50000000006
	Brücke, 3-polig, isoliert, BRI/3-5.0/5.08-LICHTGRAU	Art.-Nr. 50000000007
	Brücke, 2-polig, BR/2-5.0/5.08-L7.0	Art.-Nr. 50000000008

Details, sowie allgemeines Zubehör s. Katalog S. 282 ff. Serviceleistungen siehe Katalog S. 12/13.

Zulassungsdaten

UseGroup					
	B	C	D		
Nennspannung	300 V	-	300 V	250 V	
Nennstrom	15 A	-	10 A	17.5 A	
Nennleitergröße				min	max
- starr	AWG 22-14	-	AWG 22-14	0.5 mm ²	1.5 mm ²
- flexibel	AWG 22-14	-	AWG 22-14	0.5 mm ²	1.5 mm ²
Drehmoment	0.40 Nm	-	0.40 Nm	0.40 Nm	
Schraubengewinde	M2.6	-	M2.6	M2.6	
Prüfspannung	1.60 kV	-	1.60 kV	2.0 kV	