

SOT-223



Pin Definition:

1. Input
2. Ground (tab)
3. Output

General Description

TS4264 is a 5V low-drop fixed-voltage regulator in an SOT-223 package. The IC regulates an input voltage in the range of $5.5V < V_{IN} < 45V$ to $V_{OUT} \text{ (rated)} = 5.0V$. The maximum output current is more than 150mA. This IC is designed with short circuit-proof and features temperature protection that disables the circuit at over-temperature.

Features

- Fixed Output Voltage 5V
- Output Voltage Tolerance $\pm 2\%$
- 150mA Current Capability
- Ultra Low Dropout Voltage
- Over Temperature Protection
- Very Low Current Consumption 400uA (max.)
- Short-Circuit Proof
- Reverse Polarity Proof
- Wide Temperature Polarity Range
- Suitable for use in Automotive Electronics

Ordering Information

Part No.	Package	Packing
TS4264CW50 RP	SOT-223	2.5Kpcs / 13" Reel

Pin Definition and Function

Pin	Symbol	Function
1	Input	Block to ground directly on IC with ceramic capacitor
2	Ground	Ground
3	Output	Block to ground with 10uF capacitor, ESR < 10Ω

Block Diagram

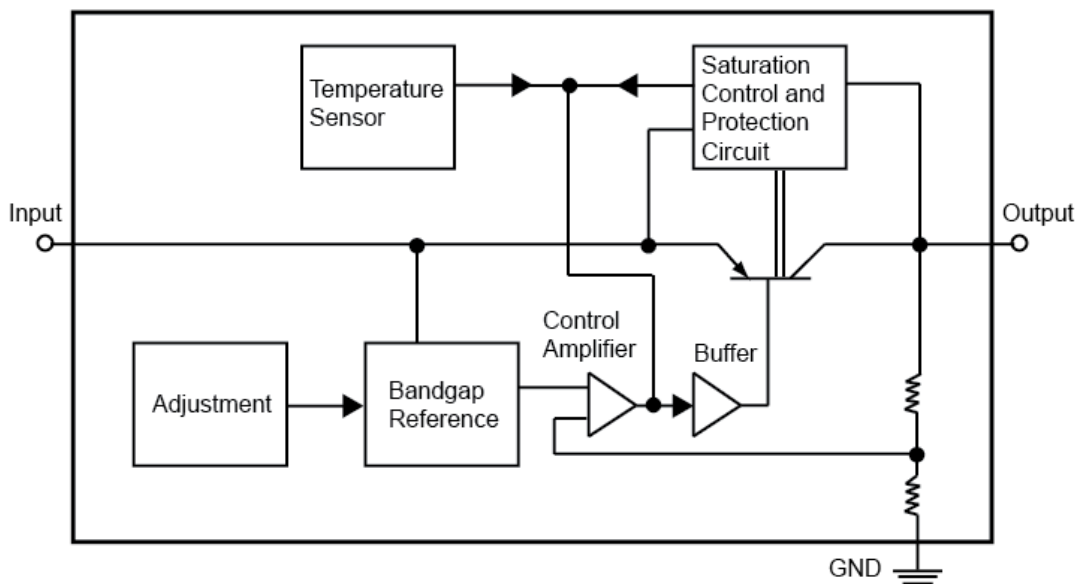

Absolute Maximum Rating

Parameter	Symbol	Limit Values		Unit	Notes
		Min.	Max.		
Input Voltage	V_{IN}	-42	45	V	
Input Voltage (Operating Range)	$V_{IN(OPR)}$	5.5	45	V	
Input Current	I_{IN}	--	--	--	Internally Limited
Output Voltage	V_{OUT}	-0.3	32	V	
Output Current	I_{OUT}	--	--	--	Internally Limited
Ground Current	I_{GND}	50	--	mA	
Junction Temperature	T_J	--	150	°C	
Junction Temperature (Operating Range)	$T_{J(OPR)}$	-40	150	°C	
Storage Temperature	T_{STG}	-50	150	°C	

Thermal Performance

Parameter	Symbol	Limit Values		Unit	Notes
		Min.	Max.		
Thermal Resistance Junction-Ambient	$R\theta_{JA}$	--	80	°C/W	
Thermal Resistance Junction-Pin	$R\theta_{JP}$	--	17	°C/W	

Note: Measured to pin 2 (tab)

Electrical Characteristics $V_{IN}=13.5V$, $-40 \leq T_J \leq +150$, unless otherwise specified.

Parameter	Symbol	Limit Values			Unit	Notes
		Min.	Typ.	Max.		
Output Voltage	V_{OUT}	4.90	5.0	5.10	V	$6V \leq V_{IN} \leq 28V$, $5mA \leq I_o \leq 100mA$
Output Current Limit	I_{OUT}	120	150	--	mA	
Current Consumption	I_Q	--	--	400	uA	$I_o=1mA$
		--	10	15	mA	$I_o=100mA$
Dropout Voltage (Note)	V_{DROP}	--	0.25	0.5	V	$I_o=100mA$
Load Regulation	REG_{LOAD}	--	50	90	mV	$5mA \leq I_o \leq 100mA$, $V_{IN} = 13.5V$
Line Regulation	REG_{LINE}	--	15	30	mV	$6V \leq V_{IN} \leq 28V$, $I_o=5mA$
Ripple Rejection	PSRR	--	54	--	dB	$f=100Hz$, $V_R=0.5V_{PP}$

Note: Dropout voltage = $V_{IN} - V_{OUT}$

(Measured where V_{OUT} has dropped 100mV from the nominal value obtained at $V_{IN} = 13.5V$)

Typical Application Circuit

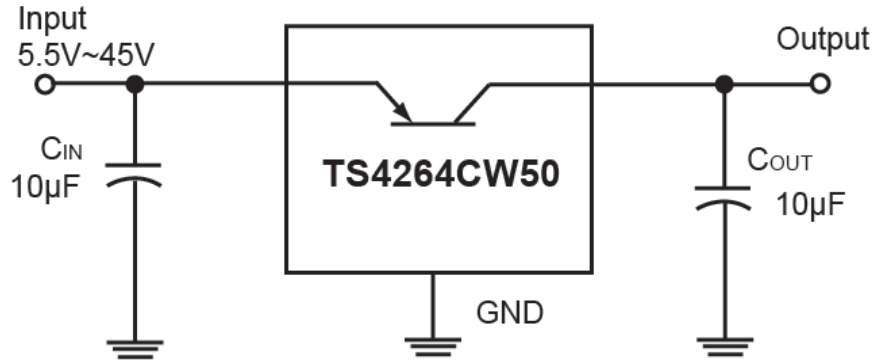

Application Information

Dimensioning Information on External Components

The input capacitor C_{IN} is necessary for compensating line influences. Using a resistor of approx. 1Ω in series with C_{IN} , the oscillating of input inductivity and input capacitance can be clamped. The output capacitor C_{OUT} is necessary for the stability of the regulating circuit. Stability is guaranteed at values $C_{OUT} \geq 10\mu F$ and an $ESR \leq 10\Omega$ within the operating temperature range.

Circuit Description

The control amplifier compares a reference voltage, which is kept highly precise by resistance adjustment, to a voltage that is proportional to the output voltage and drives the base of the series transistor via a buffer. Saturation control, working as a function of load current, prevents any over-saturation of the power element. The IC is additionally protected against overload, over temperature and reverse polarity

Electrical Characteristics Curve

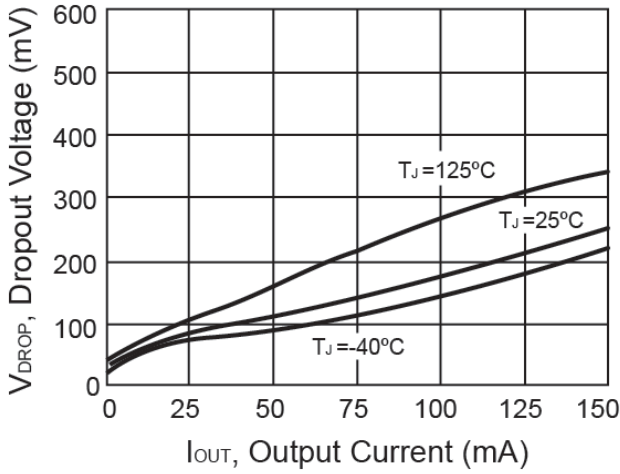

Figure 1. Output Voltage vs. Input Voltage

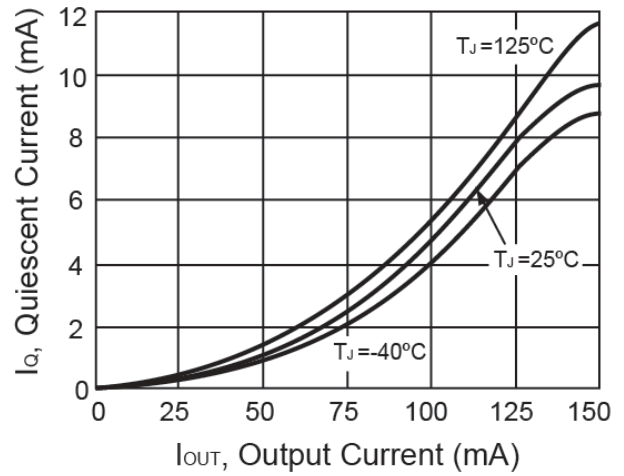

Figure 2. Quiescent Current vs. Output Current

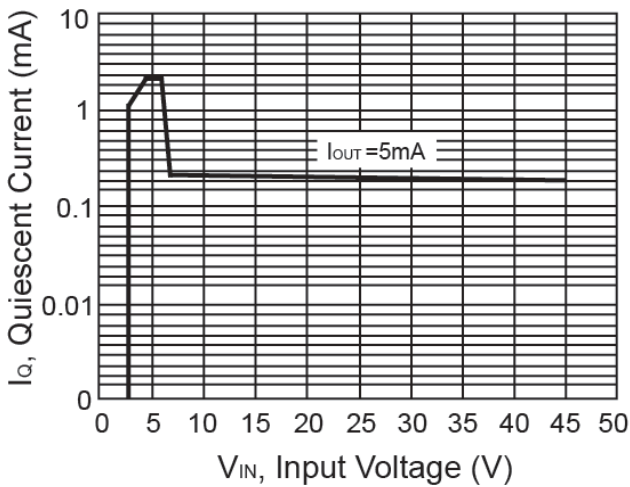

Figure 3. Quiescent Current vs. Input Voltage

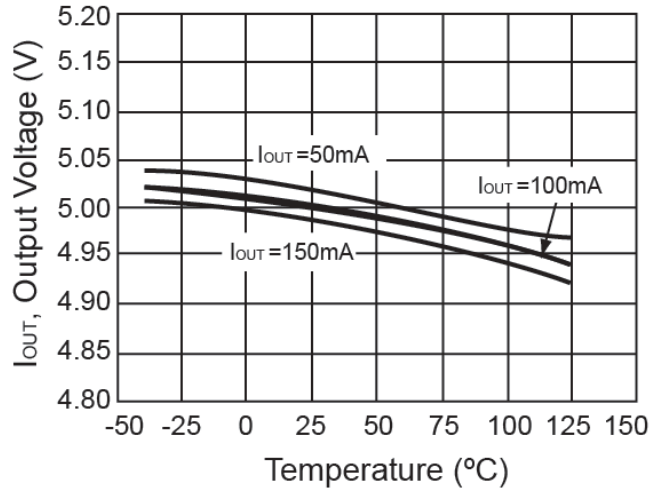

Figure 4. Output Current vs. Temperature

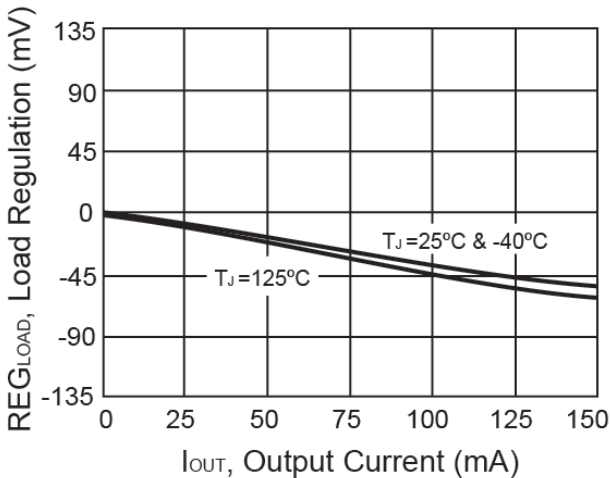

Figure 5. Load Regulation vs. Output Current

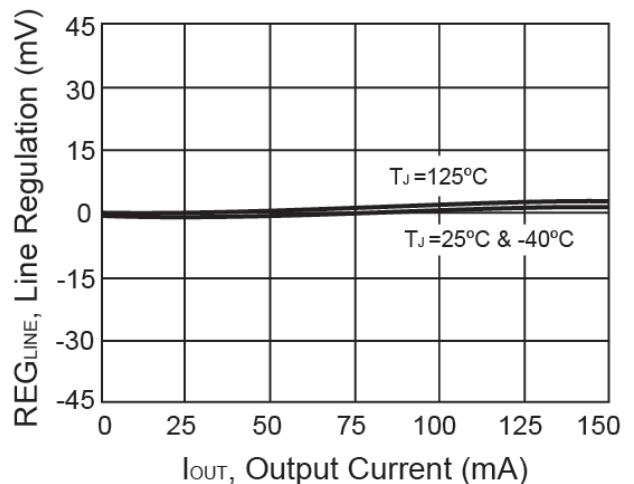
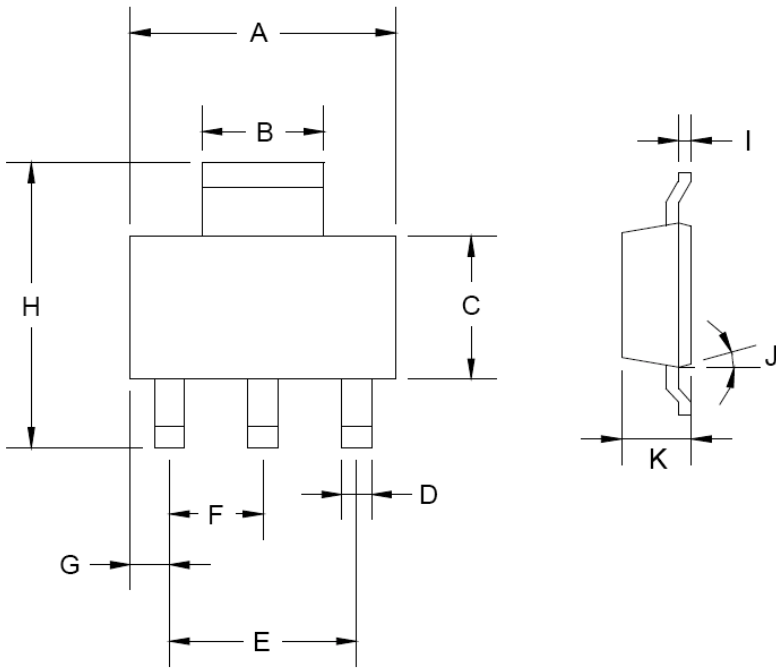

Figure 6. Line Regulation vs. Output Current

SOT-223 Mechanical Drawing



SOT-223 DIMENSION				
DIM	MILLIMETERS		INCHES	
	MIN	MAX	MIN	MAX
A	6.350	6.850	0.250	0.270
B	2.900	3.100	0.114	0.122
C	3.450	3.750	0.136	0.148
D	0.595	0.635	0.023	0.025
E	4.550	4.650	0.179	0.183
F	2.250	2.350	0.088	0.093
G	0.835	1.035	0.032	0.041
H	6.700	7.300	0.263	0.287
I	0.250	0.355	0.010	0.014
J	10°	16°	10°	16°
K	1.550	1.800	0.061	0.071

Marking Diagram

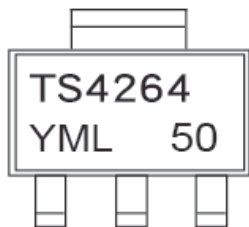

- 50** = Fixed 5V Output Voltage
- Y** = Year Code
- M** = Month Code
(**A**=Jan, **B**=Feb, **C**=Mar, **D**=Apr, **E**=May, **F**=Jun, **G**=Jul, **H**=Aug, **I**=Sep, **J**=Oct, **K**=Nov, **L**=Dec)
- L** = Lot Code

Notice

Specifications of the products displayed herein are subject to change without notice. TSC or anyone on its behalf, assumes no responsibility or liability for any errors or inaccuracies.

Information contained herein is intended to provide a product description only. No license, express or implied, to any intellectual property rights is granted by this document. Except as provided in TSC's terms and conditions of sale for such products, TSC assumes no liability whatsoever, and disclaims any express or implied warranty, relating to sale and/or use of TSC products including liability or warranties relating to fitness for a particular purpose, merchantability, or infringement of any patent, copyright, or other intellectual property right.

The products shown herein are not designed for use in medical, life-saving, or life-sustaining applications. Customers using or selling these products for use in such applications do so at their own risk and agree to fully indemnify TSC for any damages resulting from such improper use or sale.

Mouser Electronics

Authorized Distributor

Click to View Pricing, Inventory, Delivery & Lifecycle Information:

[Taiwan Semiconductor:](#)

[TS4264CW50](#)