

Morsetti per C.S.

carrello

A1 Terminal blocks for P.C.B.





rising clamp

Blocs de jonction C.I.
étrier remontant

Printklemmen
Liftprinzip

Passo Pas	Pitch Rastermaß	mm
Tensione nominale Tension nominale	Rated Voltage Bemessungsspannung	V
Corrente nominale Intensité nominale	Rated Current Bemessungsstrom	A

Tipo cavi Type du conducteur	Types of cables Leitungstypen	
Sezione nominale Section nominale	Nominal cross section Nennquerschnitt	mm² AWG
Lunghezza spelatura Longueur de dénudage	Stripping length Abisolierlänge	mm
Coppia di torsione Couple de serrage	Torque Drehmoment	Nm Lb-in
Temperatura Température	Temperature Temperatur	°C
Corpo isolante Corps isolant	Housing Isolierkörper	
Vite imperdibile Vis imperdable	Captive screw Unverlierbare Schraube	
		mm

	IMQ	EN60998
	VDE	EN60998
	UL	UL1059
	cUL	UL1059 + C22.2 n°158

Poli Pôles	Poles Polzahl	X →
Colore standard Coloris standard	Standard colour Standardfarbe	Y →
Altri dati Autres données	Other information Weitere Informationen	pag. Seite

Ordinazione Référence de commande		How to order Bestellschlüssel			
COB	10 / X	SQ	Y	...	
Tipo Type Type Typ	Passo Pitch Pas Rastermaß	Poli Poles Pôles Polzahl	Versione Version Version Version	Colori Colors Couleurs Farben	Numerazione Printing Marquage Bedruckung

Altri colori a richiesta. **Other colours on demand.**
Autres couleurs sur demande. Andere Farben bei Bedarf.

VE **GR** **NE** **AR** **BL** **RO**

COB

Modulo componibile
Elements modulaires

Interlocking modules
Zusammensteckbare Blöcke





Poli
Pôles

Poles
Polzahl

1/2



10	10,16
500	
24	

		
0,2 ÷ 4 30 ÷ 12	0,2 ÷ 2,5 30 ÷ 12	0,2 ÷ 2,5 30 ÷ 12
6		
0,5	4	
110		
PA - UL 94 V0		
M3		
	0,6 x 3,5	

V	A	mm²/AWG
750	24	0,5 ÷ 2,5
750	24	0,5 ÷ 2,5
300	16	24 ÷ 12
300	16	24 ÷ 12

min 2 - max ...
GR
70

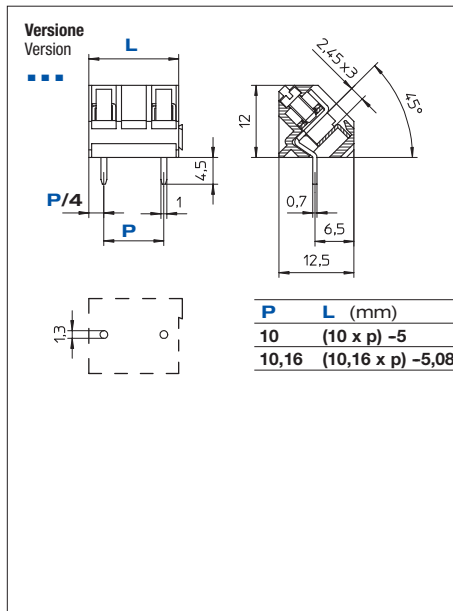

CII

Modulo componibile
Elements modulaires

Interlocking modules
Zusammensteckbare Blöcke



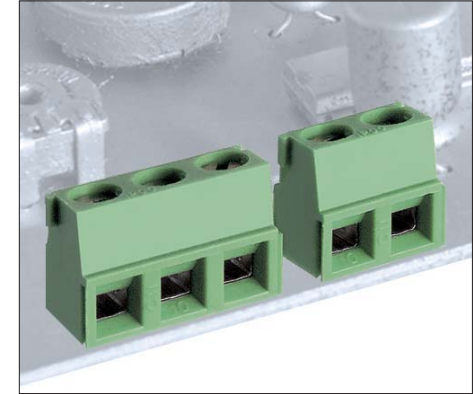

Poli
Pôles

Poles
Polzahl

2/3



5	5,08
250	
14	

		
0,2 ÷ 2,5 30 ÷ 14	0,2 ÷ 1,5 30 ÷ 14	0,2 ÷ 1,5 30 ÷ 14
6		
0,5	4	
110		
PA - UL 94 V0		
M3		
	0,6 x 3,5	

V	A	mm²/AWG
250	14	0,2 ÷ 1,5
250	14	0,2 ÷ 1,5
300	14	30 ÷ 14
300	14	30 ÷ 14

min 2 - max ...
VE
70

