

DC Square-body Fuses Sizes 2x122 - 2x123 gR 750V DC

Size 2x122
gRC - gRD from 500 to 1000 A

Dimensions

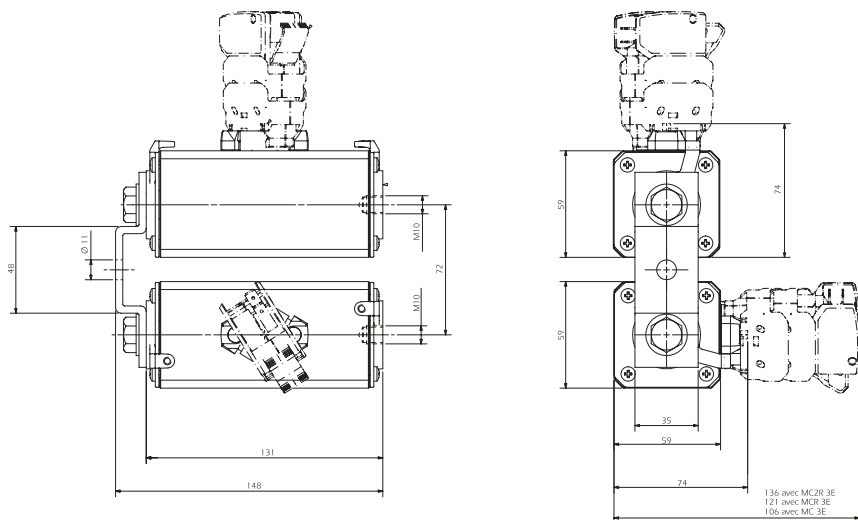

Weight: 2825 g

Main Characteristics

Size	Current rating I_N (A)	Breaking Capacity	Watts loss		Max. I^2t @ 900 V = L/R 40 ms		Designation	Ref. Number	Catalog Number
			0.8 I_N (W)	I_N (W)	$I_P = 10 I_N$ (A ² S)	$I_P = 50 I_N$ (A ² S)			
2x122	500	@ 900V DC 100 kA L/R = 40 ms	51	94	5 10 ⁶	1 10 ⁶	CC 7,5 gRC 2122 TTF 0500	Q 090473	D2122GC75V500TF
	630		63	116	8 10 ⁶	1.6 10 ⁶	CC 7,5 gRC 2122 TTF 0630	R 090474	D2122GC75V630TF
	800		81	149	12.4 10 ⁶	2.4 10 ⁶	CC 7,5 gRC 2122 TTF 0800	S 090475	D2122GC75V800TF
	900		98	180	16 10 ⁶	3.2 10 ⁶	CC 7,5 gRD 2122 TTF 0900	T 220955	D2122GD75V900TF
		@ 750 V DC 100 kA L/R = 100 ms			maximum I^2t (A ² s) @ 800 V = L/R 40 ms $I_P = 10 I_N$ $I_P = 50 I_N$				
	1000*		104	190	25 10 ⁶ *	4.8 10 ⁶ *	CC 7,5 gRD 2122 TTF 1000*	V 220956	D2122GD75V10CTF

Microswitch: MC 3E 1-5N Ref. Number: D310020

* Max I^2t @ 800V = 750 VDC 100 kA L/R = 50 ms and breaking capacity @750 VDC 100 kA L/R = 50 ms

Pack: 1 piece



DC Square-body Fuses Sizes 2x122 - 2x123 gR 750V DC

Size 2x122
gRC - gRD from 500 to 1000 A

Electrical characteristics DC applications data

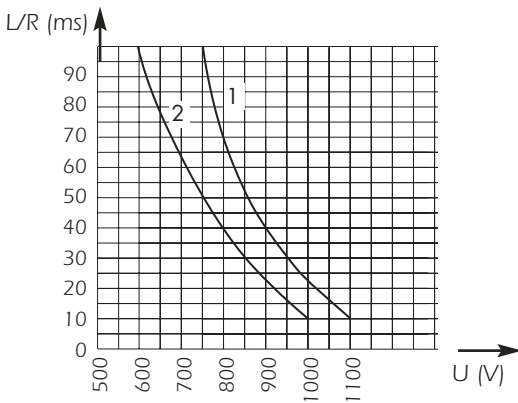

1 : curve gRC - gRD 900
2 : curve gRD 1000

Above: Curves indicate maximum permissible value of time constant L/R as a function of DC working voltage

Max. AC voltage (50/60 Hz):
1250 V with breaking capacity of 170 kA

Peak arc voltage vs. working voltage

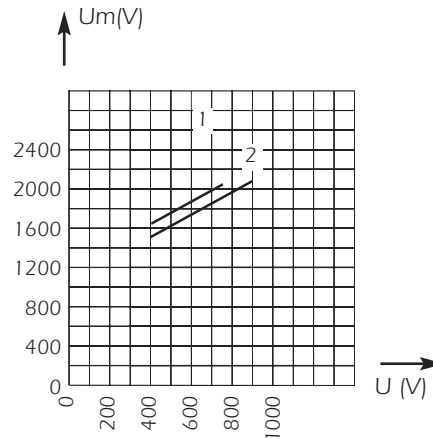

1 : $L/R = 100$ ms
2 : $L/R = 40$ ms

Above: Curves indicate for various time constants L/R the peak arc voltage which may appear across fuse terminals, vs. DC working voltage

Time vs. current characteristics

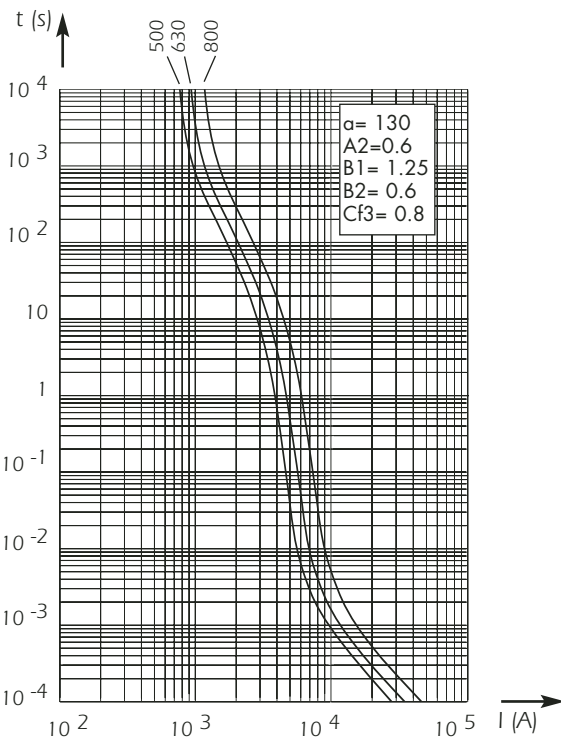

Above, left and right: Curves indicate, for each rated current, pre-arcing time vs. R.M.S. pre-arcing current.

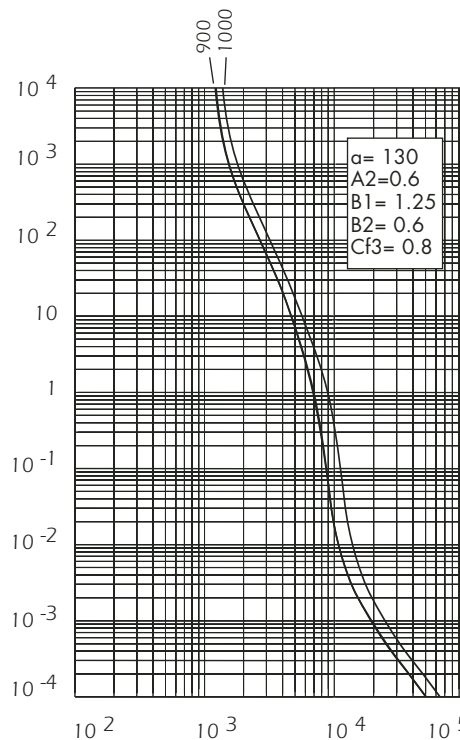

$\pm 7\%$ tolerance for mean pre-arcing current

DC Square-body Fuses Sizes 2x122 - 2x123 gR 750V DC

Size 2x123
gRC-gRB-gRD from 1000 to 1600 A

Dimensions

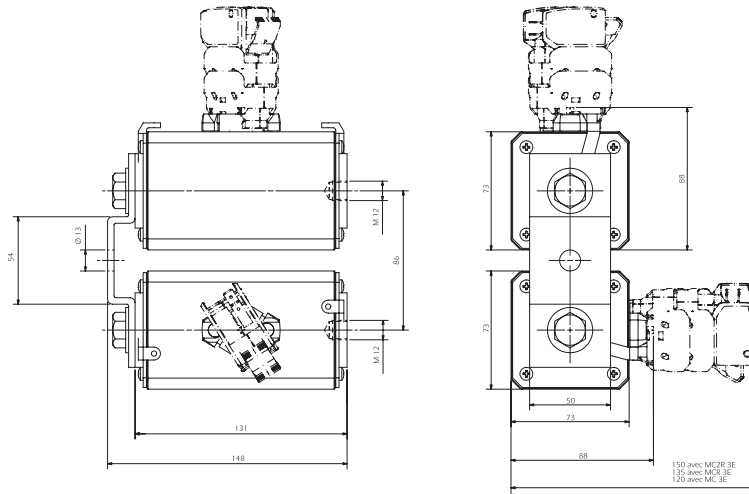

Weight: 4190 g



Main Characteristics

Size	Current rating I_N (A)	Breaking Capacity	Watts loss		Max. I^2t @ 900 V = L/R 40 ms $I_p = 10 I_N$ $I_p = 50 I_N$ (A ² S)		Designation	Ref. Number	Catalog Number
			0.8 I_N (W)	I_N (W)					
2x123	1000	@ 750 V DC 100 kA L/R = 100 ms @ 900 V DC 100 kA L/R = 40 ms	102	187	20 10 ⁶	4 10 ⁶	CC 7,5 gRC 2123 TTF 1000	Z 090481	D2123GC75V10CTF
					maximum I^2t (A ² s) @ 800 V = L/R 40 ms $I_p = 10 I_N$ $I_p = 50 I_N$				
	1250	@ 750 V DC 100 kA	148		30 10 ⁶	6 10 ⁶	CC 7,5 gRB 2123 TTF 1250	D 098558	D2123GB75V12CTF
	1400	100 kA	164		40 10 ⁶	8 10 ⁶	CC 7,5 gRB 2123 TTF 1400	B 090483	D2122GB75V14CTF
	1500	L/R = 50 ms	164		40 10 ⁶	8 10 ⁶	CC 7,5 gRD 2123 TTF 1500	K 220947	D123GD75V1500TF
			74		maximum I^2t (A ² s) @ 660 V = L/R 30 ms $I_p = 10 I_N$ $I_p = 50 I_N$				
			82						
			82						
	1600	@ 660 V DC 100 kA L/R = 50 ms	180		48.6 10 ⁶	10.10 ⁶	CC 6.6 gRB 2123 TTF 1600	L 220948	D123GB66V1600TF

Microswitch: MC 3E 2-5N Reference Number: D310020

Pack: 1 piece



DC Square-body Fuses Sizes 2x122 - 2x123 gR 750V DC

Size 2x123
gRC-gRB-gRD from 1000 to 1600 A

Electrical characteristics DC applications data

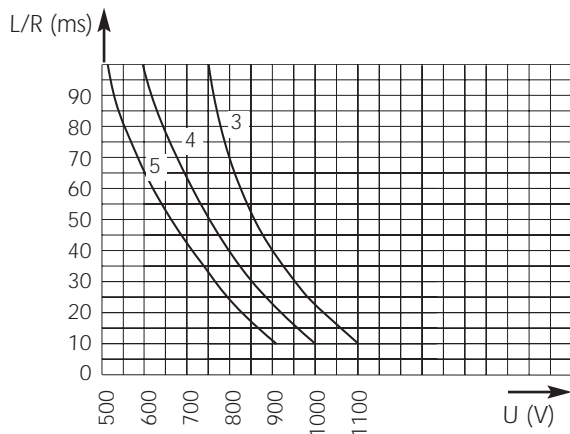

3: curve gRC
4: curve gRD
5: curve gRB 1600 A

Above: Curves indicate maximum permissible value of time constant L/R as a function of DC working voltage.

Max. AC voltage (50/60 Hz):
1250 V with breaking capacity of 170 kA

Peak arc voltage vs. working voltage

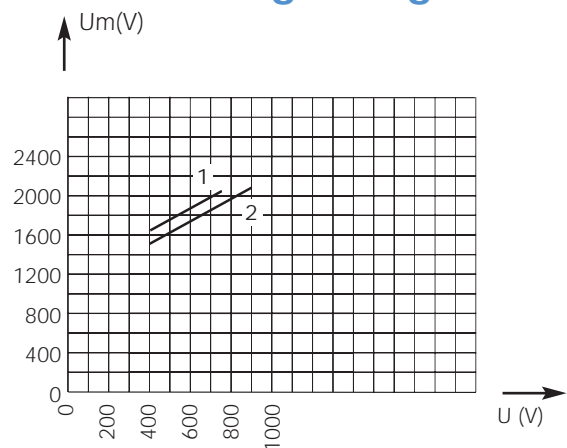

1: L/R = 100 ms

2: L/R = 40 ms

Above: Curves indicate for various time constants L/R the peak arc voltage which may appear across fuse terminals, vs. DC working voltage

Time vs. current characteristics

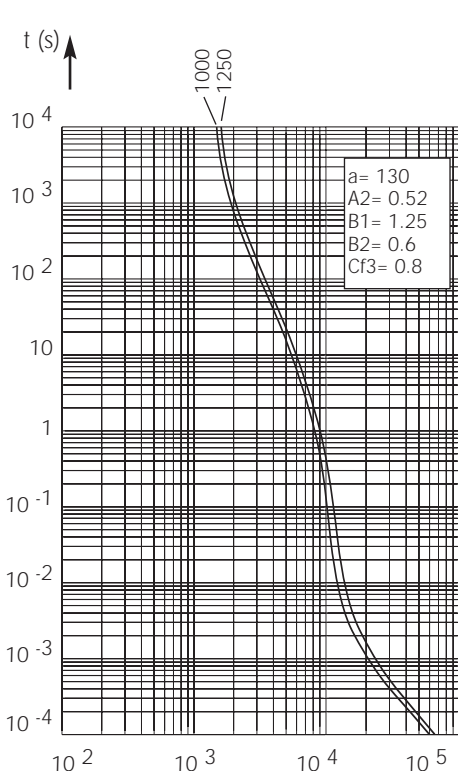

Current rating (A)	1250	1100	Maximum operating current (A)
	1400	1200	
	1500	1200	
	1600	1300	

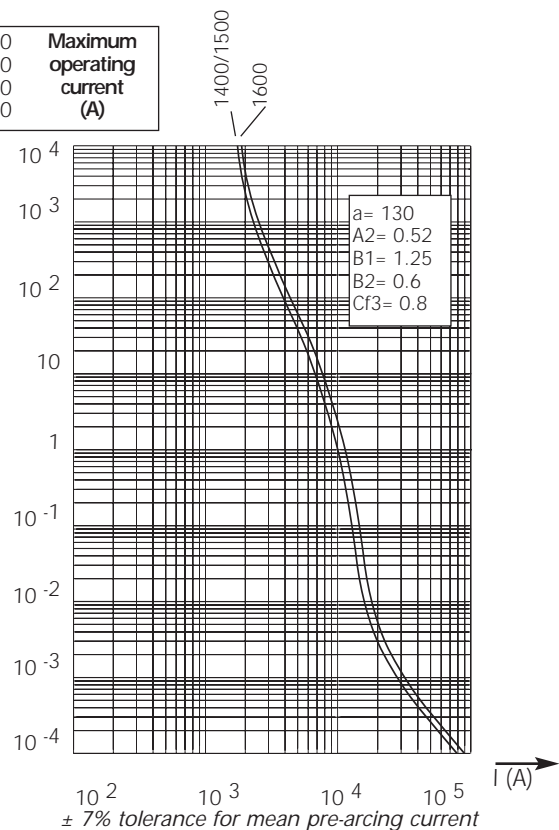

Above, left and right: Curves indicate, for each rated current, pre-arcing time vs. R.M.S. pre-arcing current.

± 7% tolerance for mean pre-arcing current