

# LIQUID CRYSTAL DISPLAY MODULE

## Product Specification

<b>CUSTOMER</b>	<b>Standard</b>
<b>CUSTOMER PART NUMBER</b>	
<b>PRODUCT NUMBER</b>	<b>DET043WVNMCMIS-4A</b>

Authorised By	Created By
<b>Bruno Recaldini</b>	<b>Luo Luo</b>
Date: 08-Jul-15	Date: 08-Jul-15

## TABLE OF CONTENTS

<b>1</b>	<b>MAIN FEATURES</b> .....	<b>4</b>
<b>2</b>	<b>MECHANICAL SPECIFICATION</b> .....	<b>5</b>
2.1	MECHANICAL CHARACTERISTICS.....	5
2.2	MECHANICAL DRAWING.....	6
<b>3</b>	<b>ELECTRICAL SPECIFICATION</b> .....	<b>9</b>
3.1	ABSOLUTE MAXIMUM RATINGS.....	9
3.2	DC ELECTRICAL CHARACTERISTICS .....	10
3.3	INTERFACE PIN ASSIGNMENT .....	11
3.4	TIMING CHARACTERISTICS .....	13
3.5	POWER SEQUENCE .....	20
<b>4</b>	<b>OPTICAL SPECIFICATION</b> .....	<b>21</b>
4.1	OPTICAL CHARACTERISTICS .....	21
<b>5</b>	<b>BACKLIGHT SPECIFICATION</b> .....	<b>23</b>
5.1	LED DRIVING CONDITIONS .....	23
5.2	LED CIRCUIT .....	23
<b>6</b>	<b>QUALITY ASSURANCE SPECIFICATION</b> .....	<b>24</b>
6.1	DELIVERY INSPECTION STANDARDS .....	24
6.2	DEALING WITH CUSTOMER COMPLAINTS.....	29
<b>7</b>	<b>RELIABILITY SPECIFICATION</b> .....	<b>30</b>
7.1	RELIABILITY TESTS.....	30
<b>8</b>	<b>HANDLING PRECAUTIONS</b> .....	<b>31</b>

**REVISION RECORD**

<b>Rev.</b>	<b>Date</b>	<b>Page</b>	<b>Chapt.</b>	<b>Comment</b>	<b>ECN no.</b>
1.0	08-Jul-15			Initial Release	

## 1 MAIN FEATURES

ITEM	CONTENTS
Screen Size	4.3" Diagonal
Display Format	480 x RGB x 800 Dots
N° of Colour	65K/262K/16.7M
TFT Active Area	56.16 mm (H) x 93.6 mm (V)
PCT View Area	57.16 mm (H) x 94.6 mm (V)
LCD Type	TFT
Mode	IPS Transmissive / Normally Black
Viewing Direction	Full view
TFT Interface	3-line SPI + 16/18/24-bit RGB interface
PCT Interface	I2C
TFT Driver IC	ILI9806E or equivalent
PCT Driver IC	GT911
Simultaneous Touch Points	5
Backlight Type	LED
Operating Temperature	-20°C ~ +70°C
Storage Temperature	-30°C ~ +80°C
RoHS compliant	Yes

## 2 MECHANICAL SPECIFICATION

### 2.1 MECHANICAL CHARACTERISTICS

---

ITEM	CHARACTERISTIC	UNIT
Display Format	480 x RGB x 800 Dots	Dots
Overall Dimensions	69.16 mm (H) x 120.05 mm (V) x 4.13 mm (D)	mm
Active Area	56.16 mm (H) x 93.6 mm (V)	mm
pixel Pitch	0.117 (H) x 0.117 (V)	mm
Weight	45	g



2.2.2 PCT

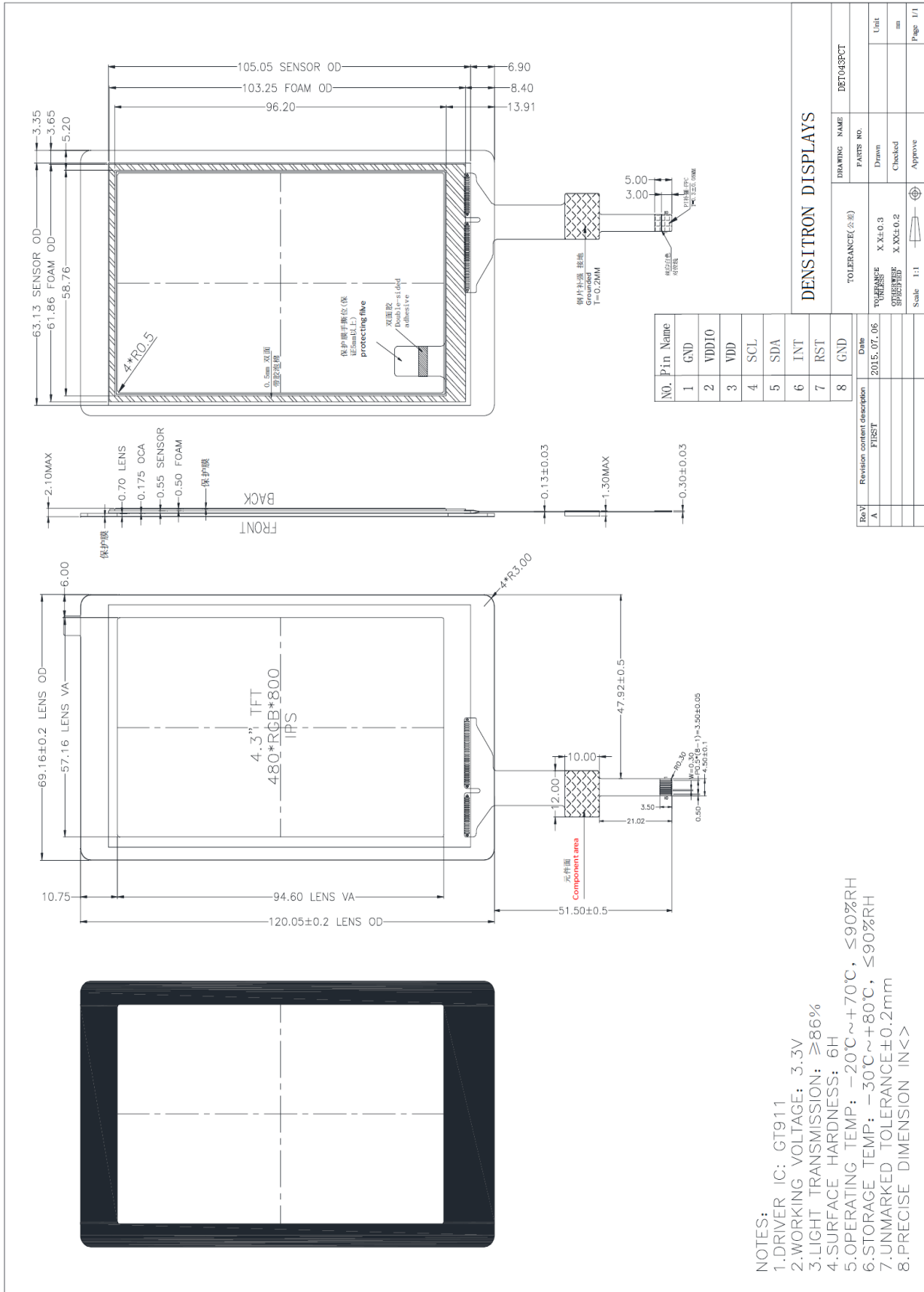

2.2.3 TFT+PCT

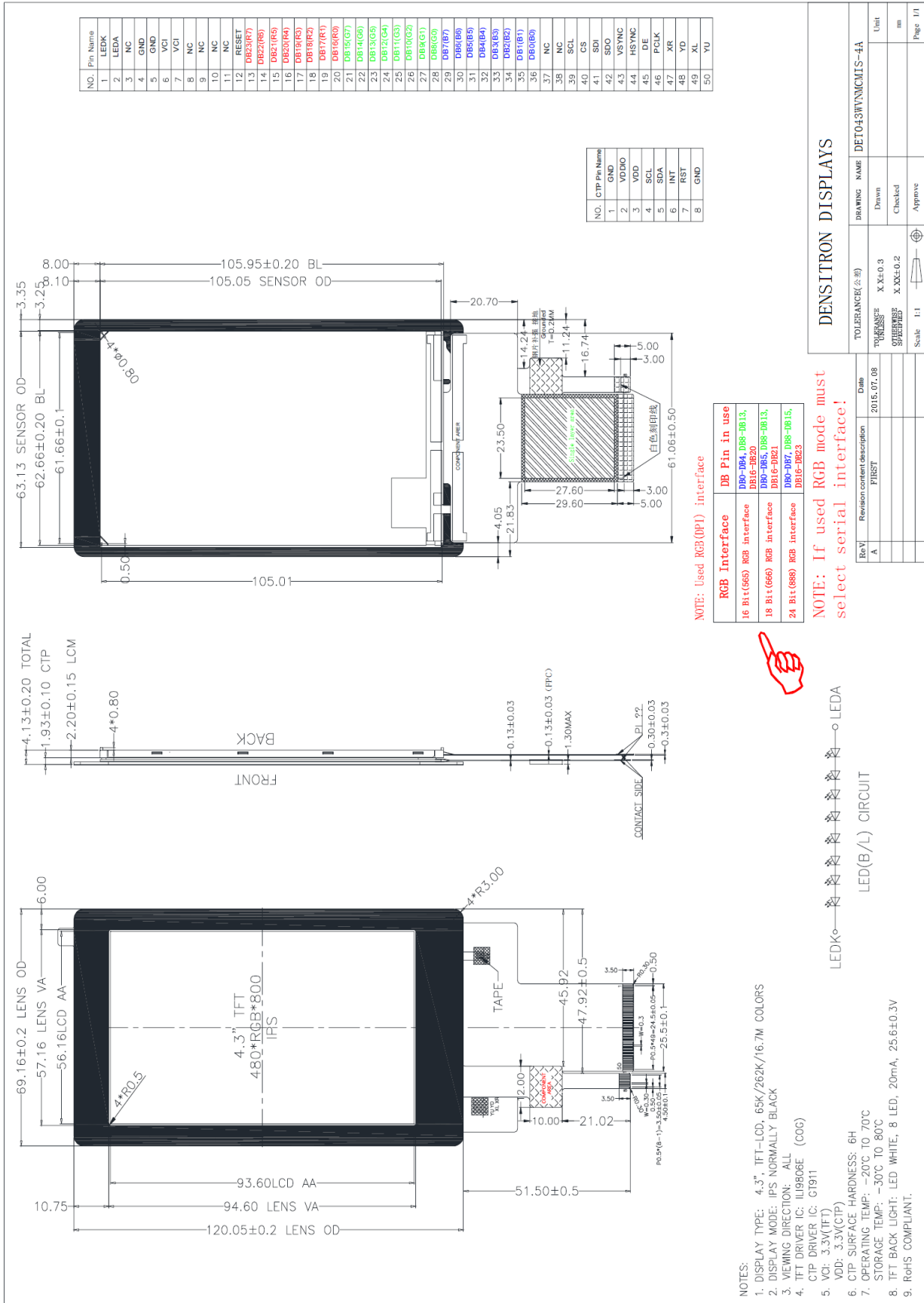

NOTE: If used RGB mode must select serial interface!

NOTE: Used RGB(8P1) interface

Rev	Revision content description	Date
A	PIRST	2015.07.08

DENSITRON DISPLAYS	
TOLERANCE(公差)	DET043WVNMCMIS-4A
SCALE	X.X±0.3
CHECKED	X.XX±0.2
APPROVE	
Unit	mm
Page	1/1



### 3 ELECTRICAL SPECIFICATION

#### 3.1 ABSOLUTE MAXIMUM RATINGS

##### 3.1.1 TFT

Item	Symbol	Condition	Min	Max	Unit	Note
Power Supply Voltage	VCI	Ta=25°C	-0.3	4.6	V	
Operating Temperature	TOP		-20	70	°C	1
Storage Temperature	TST		-30	80	°C	1,2,3

Note 1. 90 % RH Max for Ta<50 °C, and 60% RH for Ta≥50°C.

Note 2. In case of below 0°C, the response time of liquid crystal (LC) becomes slower and the colour of panel becomes darker than normal one. Level of retardation depends on temperature, because of LC's characteristic.

Note 3. Only operation is guaranteed at operating temperature. Contrast, response time, another display quality are evaluated at +25°C.

##### 3.1.2 PCT

Item	Symbol	Condition	Min	Max	Unit	Note
Power Supply Voltage	VDD	Ta=25°C	-0.3	3.47	V	4
I/O Digital voltage	VDDIO	Ta=25°C	-0.3	3.47	V	4
Operating Temperature	TOP		-20	70	°C	-
Storage Temperature	TST		-30	80	°C	-

Note 4. If used beyond the absolute maximum ratings, GT911 may be permanently damaged. It is strongly recommended that the device be used within the electrical characteristics in normal operations. If exposed to the condition not within the electrical characteristics, it may affect the reliability of the device.

### 3.2 DC ELECTRICAL CHARACTERISTICS

#### 3.2.1 TFT

Item	Symbol	Condition	Min	Typ	Max	Unit	Note
Supply Voltage	V <sub>CI</sub>		2.5	3.3	3.6	V	
Input Voltage for Logic	V <sub>IH</sub>		0.7V <sub>CI</sub>	-	V <sub>CI</sub>	V	
	V <sub>IL</sub>		GND	-	0.3 V <sub>CI</sub>	V	
Output Voltage for Logic	V <sub>OH</sub>		V <sub>CI</sub> -0.4	-	-	V	
	V <sub>OL</sub>		GND	-	V <sub>CI</sub> +0.4	V	
Current Consumption	ICC		-	30	-	mA	1

Note 1: The specified power consumption is under the conditions of V<sub>CI</sub>=3.3V, F<sub>V</sub>=60Hz.

#### 3.2.2 PCT

Item	Symbol	Condition	Min	Typ	Max	Unit	Note
Supply Voltage	VDD		2.8	-	3.3	V	
I/O Digital Supply Voltage	VDDIO		1.8	-	3.3		
Input Voltage for Logic	V <sub>IH</sub>		0.75VDDIO	-	VDDIO+0.3	V	
	V <sub>IL</sub>		-0.3	-	0.25VDDIO	V	
Output Voltage for Logic	V <sub>OH</sub>		0.85VDDIO	-	-	V	
	V <sub>OL</sub>		-	-	0.15VDDIO	V	
Normal operation mode Current Consumption	IOPR		-	8	14.5	mA	
Green mode Current Consumption	IMON		-	3.3	-	mA	
Sleep mode Current Consumption	ISLP		70	-	120	uA	

### 3.3 INTERFACE PIN ASSIGNMENT

#### 3.3.1 LCM PIN ASSIGNMENT

Recommended connector: Omron XF2M-5015-1A

Pin NO.	Symbol	Function
1	LEDK	Power supply for Backlight
2	LEDA	
3	NC	Not Connected
4	GND	Ground
5	GND	
6	VCI	Analogue power supply, 2.8V~3.3V.
7	VCI	
8	NC	Not Connected
9	NC	
10	NC	
11	NC	
12	RESX	Reset pin, active low
13-36	DB23-DB16 (R7-R0)  DB15-DB8 (G7-G0)  DB7-DB0 (B7-B0)	24-bit bi-directional data bus. 24-bit bus: use DB23-DB0 16-bit bus: use DB20-DB16, DB13-DB8, DB4-DB0 18-bit bus: use DB21-D16, DB13-DB8, DB5-DB0 Please connect unused pins to GND.
37	NC	Not Connected
38	NC	Not Connected
39	SCL	Serial Clock Input
40	CSX	Chip select signal. Low: chip can be accessed; High: chip cannot be accessed. If not used, please connect to GND.
41	SDI (SDA)	Serial data input pin used for the SPI Interface. SDI : Serial data input pin SDA : Serial data input/output bidirectional pin
42	SDO	Serial data output pin in serial bus system interface. If not used, please leave this pin open.
43	VS	Frame synchronizing signal for RGB (DPI) I/F mode.
44	HS	Line synchronizing signal for RGB (DPI) I/F mode.

Pin NO.	Symbol	Function
45	DE	Data Enable signal for RGB (DPI) I/F mode. Low : access enabled
46	PCLK	Pixel clock signal for RGB (DPI) I/F mode.
47	XR	Not Connected
48	YD	Not Connected
49	XL	Not Connected
50	YU	Not Connected

### 3.3.2 PCT PIN ASSIGNMENT

Pin NO.	Symbol	Function
1	GND	Ground
2	VDDIO	I/O power supply voltage.
3	VDD	Supply voltage
4	SCL	I2C clock input
5	SDA	I2C data input and output
6	INT	External interrupt to the host
7	RST	External Reset, Low is active
8	GND	Ground

### 3.4 TIMING CHARACTERISTICS

Please refer to IC ILI9806E datasheet for more information

#### 3.4.1 Display RGB (DPI) Interface Timing

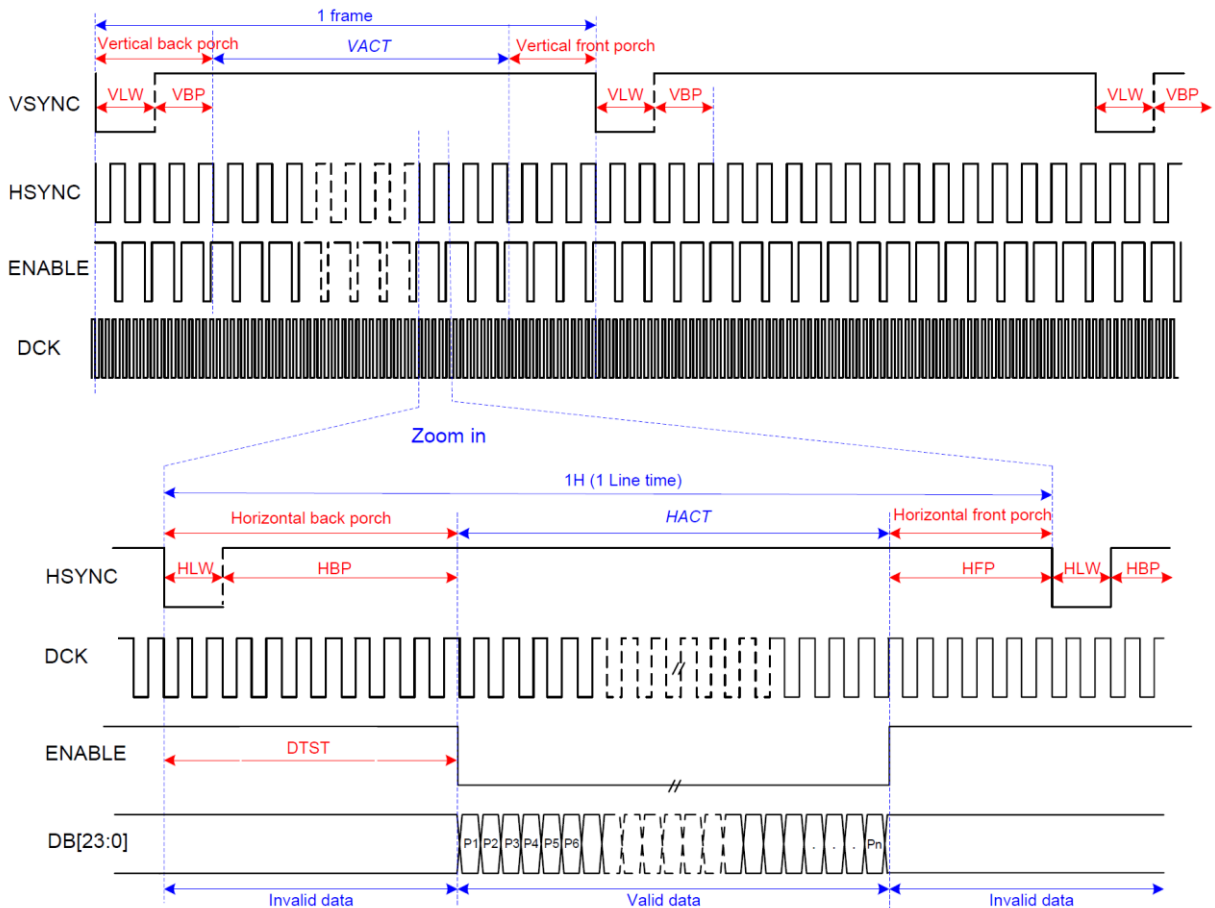

VLW : VSYNC Low pulse Width  
 HLW : HSYNC Low pulse Width  
 DTST : Data Transfer Startup Time  
 Pn : pixel 1, pixel 2..., pixel n.

Parameter	Symbols	Min.	Typ.	Max.	Units
Frame Rate	FR	54		66	fps
Horizontal Low Pulse width	HLW	1		-	DOTCLK
Horizontal Back Porch	HBP	2		126	DOTCLK
Horizontal Address	HACT		480		DOTCLK
Horizontal Front Porch	HFP	2		-	DOTCLK
Vertical Low Pulse width	VLW	1		126	Line
Vertical Back Porch	VBP	1		126	Line
Vertical Address	VACT			864	Line
Vertical Front Porch	VFP	1		255	Line
Data Clock	DCLK	16.6		41.7	MHz

### 3.4.2 Display Parallel RGB (24/18/16 bit) DPI Interface Timing

Signal	Symbol	Parameter	min	max	Unit	Description
VS/ HS	tSYNCS	VS/HS setup time	5	-	ns	24/18/16-bit bus RGB interface mode
	tSYNCH	VS/HS hold time	5	-	ns	
DE	tENS	DE setup time	5	-	ns	
	tENH	DE hold time	5	-	ns	
DB[23:0]	tPOS	Data setup time	5	-	ns	
	tPDH	Data hold time	5	-	ns	
PCLK	PWDH	PCLK high-level period	13	-	ns	
	PWDL	PCLK low-level period	13	-	ns	
	tCYCD	PCLK cycle time	28	-	ns	
	trgbr , trgbf	PCLK,HS,VS rise/fall time	-	15	ns	

Note: Ta=-20 to 70C, VCI=2.5V to 3.6V, GND=0V

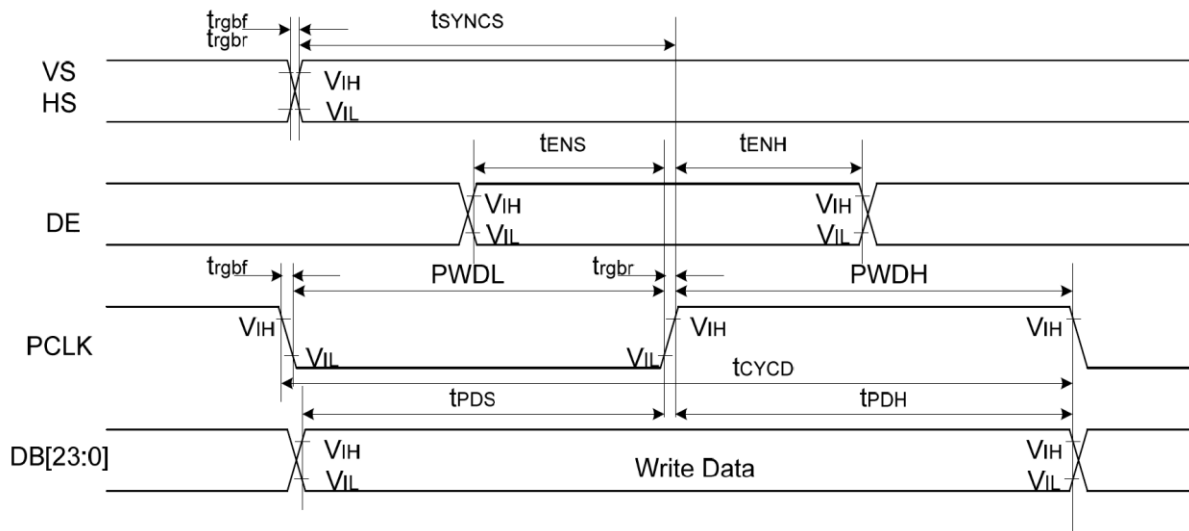

### 3.4.3 Display Serial interface Timing characteristics (3-line SPI System)

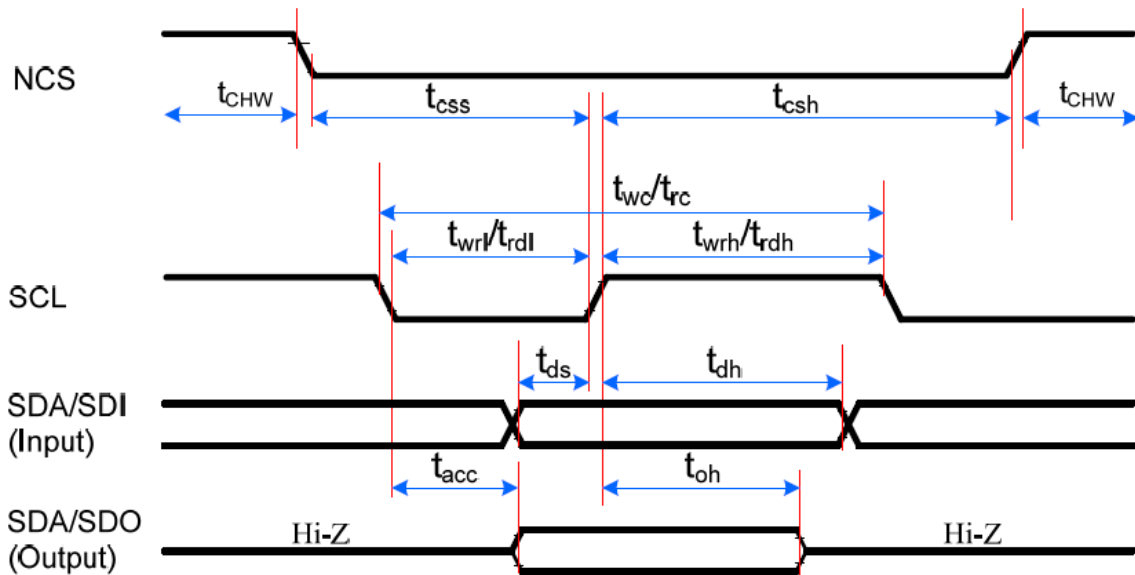

Signal	Symbol	Parameter	min	max	Unit	Description
CSX	t <sub>css</sub>	Chip select time (Write)	15	-	ns	
	t <sub>csh</sub>	Chip select hold time (Read)	15	-	ns	
	t <sub>CHW</sub>	CS "H" pulse width	40	-	ns	
SCL	t <sub>wc</sub>	Serial clock cycle (Write)	30	-	ns	
	t <sub>wrh</sub>	SCL "H" pulse width (Write)	10	-	ns	
	t <sub>wrl</sub>	SCL "L" pulse width (Write)	10	-	ns	
	t <sub>rc</sub>	Serial clock cycle (Read)	150	-	ns	
	t <sub>rdh</sub>	SCL "H" pulse width (Read)	60	-	ns	
SDA/SDO (Output)	t <sub>acc</sub>	Access time (Read)	10	100	ns	For maximum CL=30pF
	t <sub>oh</sub>	Output disable time (Read)	15	100	ns	For minimum CL=8pF
SDA/SDI (Input)	t <sub>ds</sub>	Data setup time (Write)	10	-	ns	
	t <sub>dh</sub>	Data hold time (Write)	10	-	ns	

### 3.4.4 PCT I2C Interface Timing

GT911 provides a standard I2C interface for SCL and SDA to communicate with the host. GT911 always serves as slave device in the system with all communication being initialized by the host. It is strongly recommended that transmission rate be kept at or below 400Kbps. The I2C timing is shown below:

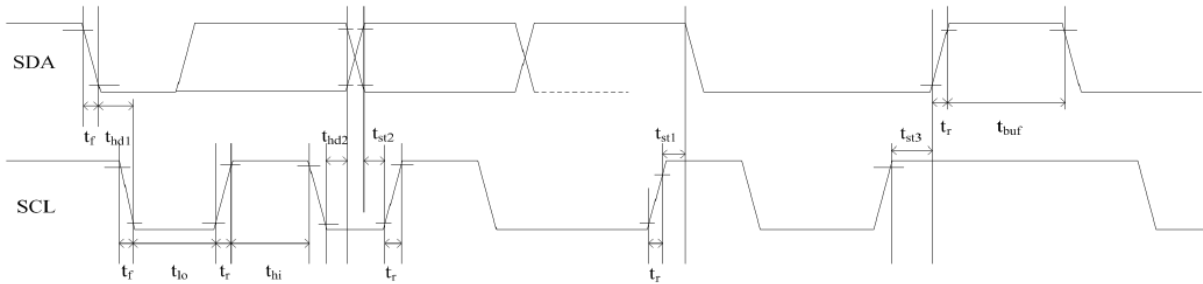

**Test condition 1: 1.8V host interface voltage, 400Kbps transmission rate, 2K pull-up resistor**

Parameter	Symbol	Min.	Max.	Unit
SCL low period	$t_{lo}$	1.3	-	us
SCL high period	$t_{hi}$	0.6	-	us
SCL setup time for Start condition	$t_{st1}$	0.6	-	us
SCL setup time for Stop condition	$t_{st3}$	0.6	-	us
SCL hold time for Start condition	$t_{hd1}$	0.6	-	us
SDA setup time	$t_{st2}$	0.1	-	us
SDA hold time	$t_{hd2}$	0	-	us

**Test condition 2: 3.3V host interface voltage, 400Kbps transmission rate, 2K pull-up resistor**

Parameter	Symbol	Min.	Max.	Unit
SCL low period	$t_{lo}$	1.3	-	us
SCL high period	$t_{hi}$	0.6	-	us
SCL setup time for Start condition	$t_{st1}$	0.6	-	us
SCL setup time for Stop condition	$t_{st3}$	0.6	-	us
SCL hold time for Start condition	$t_{hd1}$	0.6	-	us
SDA setup time	$t_{st2}$	0.1	-	us
SDA hold time	$t_{hd2}$	0	-	us

GT911 supports two I2C slave addresses: 0XBA/0Xbb and 0x28/0x29. The host can select the address by changing the status of Reset and INT pins during the power-on initialization phase. See the diagram below for configuration methods and timings:



**Power-On Timing:**

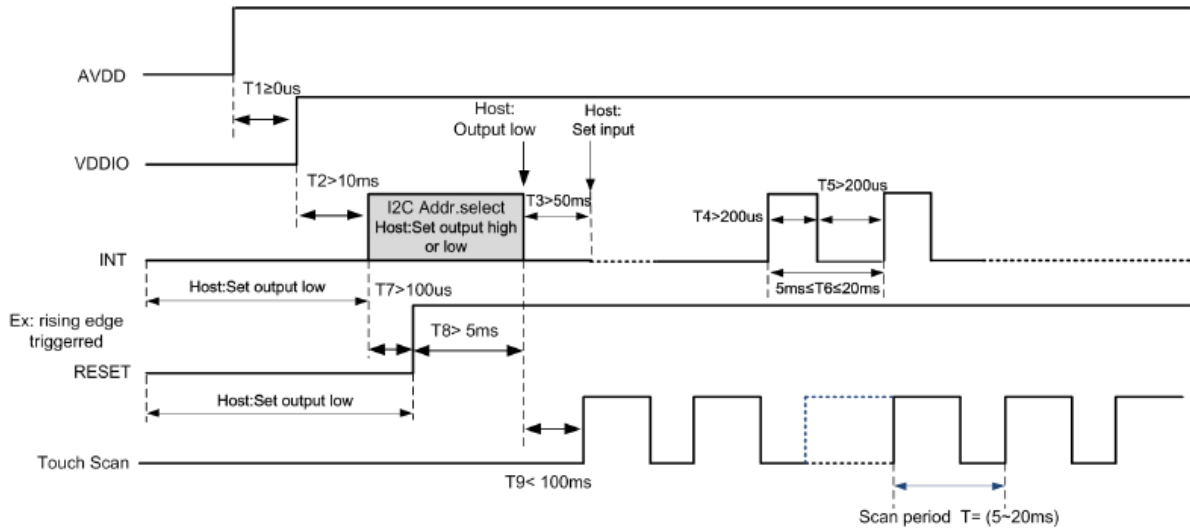

**Timing for host resetting GT911:**

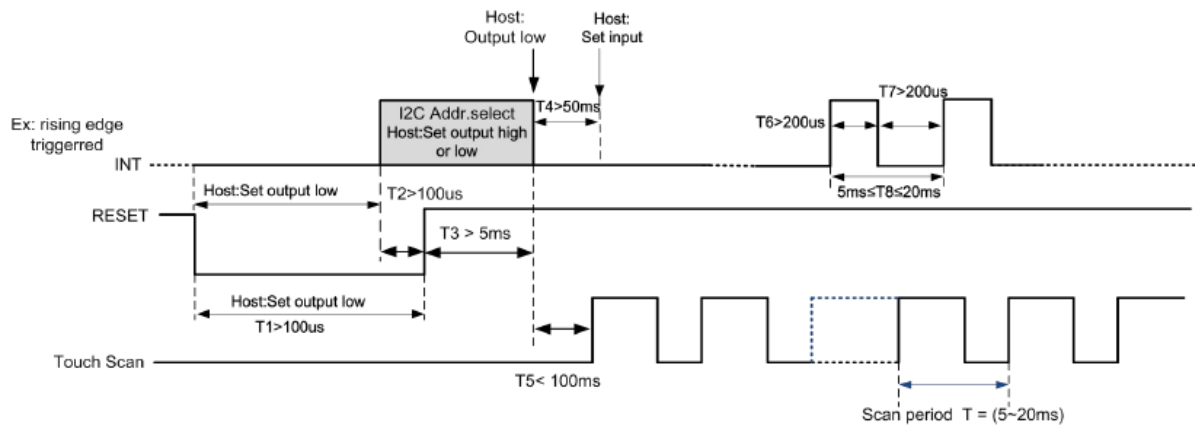

**Timing for setting slave address to 0x28/0x29:**

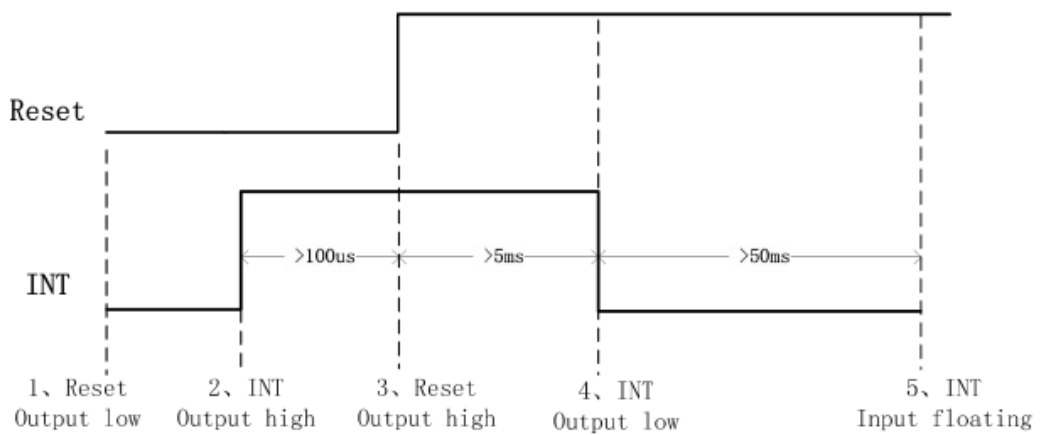

**Timing for setting slave address to 0XBA/0XBB:**

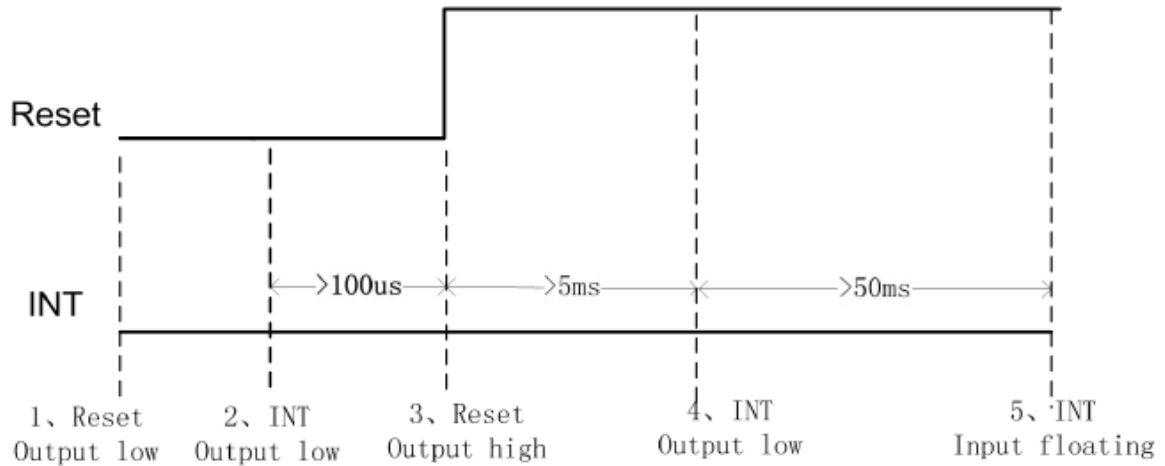

**A) Data Transmission**

(For example : device address is 0xBA/0xBB)

Communication is always initiated by the host. Valid Start condition is signalled by pulling SDA line from “high” to “low” when SCL line is “high”. Data flow or address is transmitted after the Start condition.

All slave devices connected to I2C bus should detect the 8-bit address issued after Start condition and send the correct ACK. After receiving matching address, GT911 acknowledges by configuring SDA line as output port and pulling SDA line low during the ninth SCL cycle. When receiving unmatched address, namely, not 0XBA or 0XBB, GT911 will stay in an idle state.

For data bytes on SDA, each of 9 serial bits will be sent on nine SCL cycles. Each data byte consists of 8 valid data bits and one ACK or NACK bit sent by the recipient. The data transmission is valid when SCL line is “high”.

When communication is completed, the host will issue the STOP condition. Stop condition implies the transition of SDA line from “low” to “high” when SCL line is “high”.

**B) Writing Data to GT911**

(For example: device address is 0XBA/0XBB)



**Timing for Write Operation**

The diagram above displays the timing sequence of the host writing data onto GT911. First, the host issues a Start condition. Then, the host sends 0XBA (address bits and R/W bit; R/W bit as 0 indicates Write operation) to the slave device.

After receiving ACK, the host sends the 16-bit register address (where writing starts) and the 8-bit data bytes (to be written onto the register).

The location of the register address pointer will automatically add 1 after every Write Operation. Therefore, when the host needs to perform Write Operations on a group of registers of continuous addresses, it is able to write continuously. The Write Operation is terminated when the host issues the Stop condition.

### C) Reading Data from GT911

(For example: device address is 0xBA/0xBB)

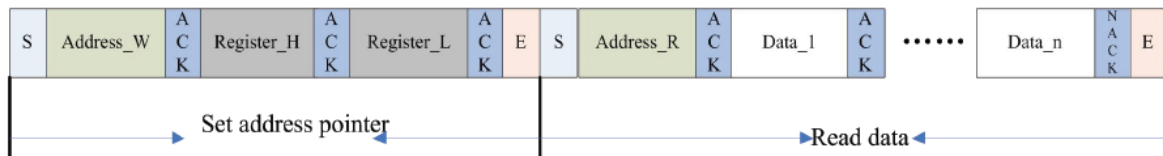

### Timing for Read Operation

The diagram above is the timing sequence of the host reading data from GT911. First, the host issues a Start condition and sends 0xBA (address bits and R/W bit; R/W bit as 0 indicates Write operation) to the slave device.

After receiving ACK, the host sends the 16-bit register address (where reading starts) to the slave device. Then the host sets register addresses which need to be read.

Also after receiving ACK, the host issues the Start condition once again and sends 0xBB (Read Operation). After receiving ACK, the host starts to read data.

GT911 also supports continuous Read Operation and, by default, reads data continuously. Whenever receiving a byte of data, the host sends an ACK signal indicating successful reception. After receiving the last byte of data, the host sends a NACK signal followed by a STOP condition which terminates communication.

### 3.5 POWER SEQUENCE

#### 3.5.1 RESET Input Timing

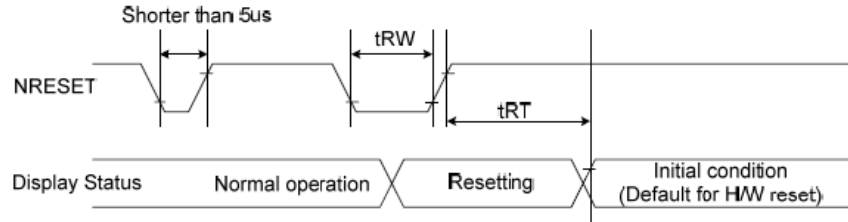

Figure 102 Reset Timing

Table 41 Reset Timing

Signal	Symbol	Parameter	Min	Max	Unit
RESX	tRW	Reset pulse duration	10		us
	tRT	Reset cancel		5(note 1,5) 120 (note 1,6,7)	ms

Note:

1. The reset cancel includes also required time for loading ID bytes, VCOM setting and other settings from OTP to registers. This loading is done every time when there is H/W reset cancel time (tRT) within 5 ms after a rising edge of RESX.
2. Spike due to an electrostatic discharge on RESX line does not cause irregular system reset according to the Table 43.

Table 42 Reset Descript

RESX Pulse	Action
Shorter than 5us	Reset Rejected
Longer than 9us	Reset
Between 5us and 9us	Reset starts

3. During the Resetting period, the display will be blanked (The display is entering blanking sequence, which maximum time is 120 ms, when Reset Starts in Sleep Out mode. The display remains the blank state in Sleep In mode.) and then return to Default condition for Hardware Reset.
4. Spike Rejection also applies during a valid reset pulse as shown below:

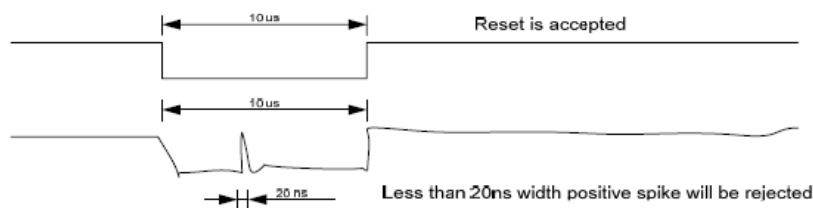

Figure 103 Positive Noise Pulse during Reset Low

5. When Reset applied during Sleep In Mode.
6. When Reset applied during Sleep Out Mode.
7. It is necessary to wait 5msec after releasing RESX before sending commands. Also Sleep Out command cannot be sent for 120msec.

#### 3.5.2 Power on/off Sequence

Please refer to IC ILI9806E datasheet.

## 4 OPTICAL SPECIFICATION

### 4.1 OPTICAL CHARACTERISTICS

Driving condition: VCI = 3.3V, VSS = 0V  
 Backlight: IF=20mA  
 Measured temperature: Ta = 25° C

Item	Symbol	Condition	MIN	TYP	MAX	Unit	Note
Response Time	TR+TF	$\theta=\phi=0^\circ$ Normal Viewing Angle	-	30	40	ms	2
Contrast Ratio	CR		-	800	-		3
Viewing Angle	Left	CR ≥ 10	-	80	-	deg	4
	Right		-	80	-	deg	
	Up		-	80	-	deg	
	Down		-	80	-	deg	
Colour Chromaticity	Red	Rx	0.444	0.459	0.474	-	5
		Ry	0.516	0.526	0.536	-	
	Green	Gx	0.111	0.120	0.129	-	
		Gy	0.544	0.550	0.556	-	
	Blue	Bx	0.121	0.136	0.151	-	
		By	0.216	0.246	0.276	-	
	White	Wx	-	0.192	-	-	
		Wy	-	0.468	-	-	
Centre Brightness		If=20mA	340	470	-	cd/m <sup>2</sup>	6
Brightness Distribution			80	-	-	%	7

### 4.1.1 Test Method

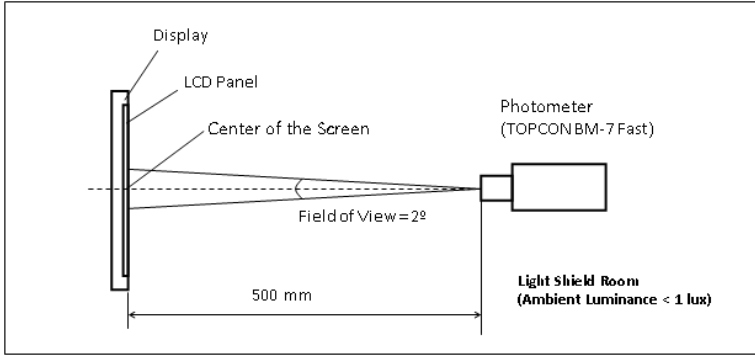
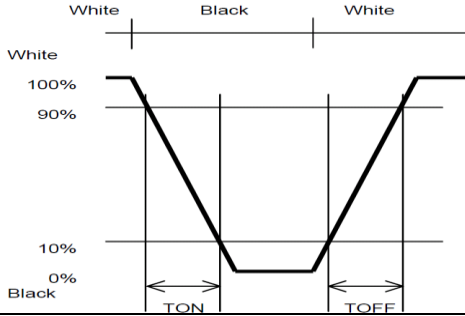
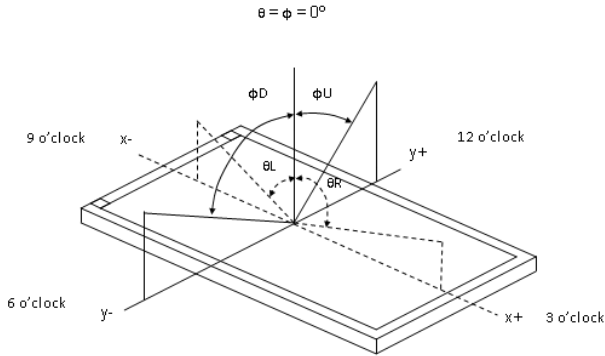
Note	Item	Test method
1	Setup	<p>The display should be stabilised at a given temperature for 30 minutes to avoid abrupt temperature change during measuring. In order to stabilise the luminance, measurements should be executed after lighting the backlight for 30 minutes in a windless room.</p> 
2	Response time	<p>Measure output signal waveform by the luminance meter when raster of window pattern is changed from white to black and from black to white.</p> 
3	Contrast ratio	<p>Measure maximum brightness and minimum brightness at the centre of the screen by displaying raster or window pattern. Then calculate the ratio between these two values.</p> $\text{Contrast Ratio (CR)} = \frac{\text{Brightness of unselected position (white)}}{\text{Brightness of selected position (black)}}$
4	Viewing angle Horizontal $\theta$ Vertical $\phi$	<p>Move the luminance meter from right to left and up and down and determinate the angles where contrast ratio is 10</p> 
5	Colour chromaticity	Measure chromaticity coordinates x and y of CIE1931 colorimetric system
6	Centre brightness	Measure the brightness at the centre of the screen
7	Brightness distribution	<p>(Brightness distribution) = <math>100 \times B/A \%</math>  A: max. brightness of the 9 points  B: min. brightness of the 9 points</p>

## 5 BACKLIGHT SPECIFICATION

### 5.1 LED DRIVING CONDITIONS

---

The back light system is edge-lighting type with 8 chips White LED

Item	Symbol	Condition	Min	Typ	Max	Unit
Forward Current	IF	Ta=25 °C,	15	20	-	mA
Forward Voltage	VF	Ta= 25°C,		25.6		V
LED life time	Hr	Ta= 25°C,	-	-	50000	Hour

Note:

- The lifetime of the LED is defined as a period till the brightness of the LED decreases to the half of its initial value.
- This figure is given as a reference purpose only, and not a guarantee.
- This figure is estimated for an LED operating alone.  
The performance of an LED may differ when assembled as a monitor together with a TFT panel due to different environmental temperature.
- Estimated lifetime could vary on a different temperature and usually higher temperature could reduce the life significantly.

### 5.2 LED CIRCUIT

---



## 6 QUALITY ASSURANCE SPECIFICATION

### 6.1 DELIVERY INSPECTION STANDARDS

#### 6.1.1 Inspection Conditions

Inspection distance: 30 cm ± 2 cm  
Viewing angle: ±45°

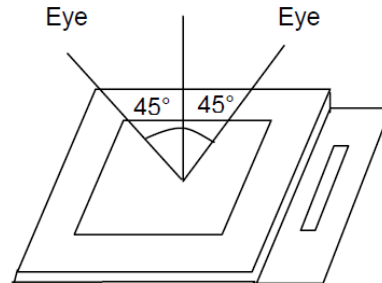

#### 6.1.2 Environmental Conditions

Ambient temperature: 25°C ±5°C  
Ambient humidity: 65±10% RH  
Ambient illumination: 300~700 lux

#### 6.1.3 Sampling Conditions

1. Lot size: quantity of shipment lot per model
2. Sampling method:

Sampling Plan		GB/T 2828-2003
		Normal inspection, Single Sampling, ClassII
AQL	Major Defect	0.65%
	Minor Defect	1.5%

#### 6.1.4 Definition of Area

A zone: active area  
B zone: viewing area

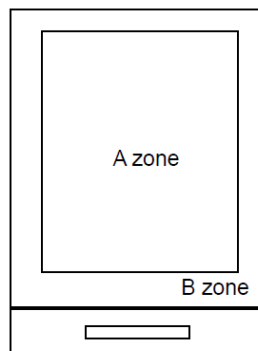

#### 6.1.5 Basic Principle

A set of sample to indicate the limit of acceptable quality level shall be discussed should a dispute occur.



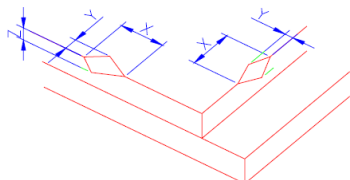
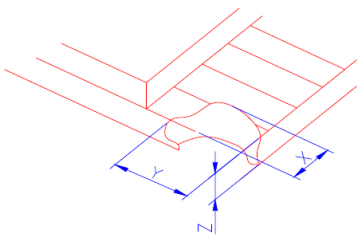
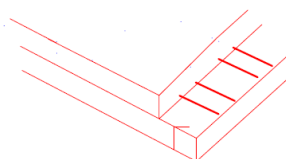

### 6.1.6 Inspection Criteria

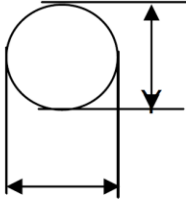
Number	Items	Criteria(mm)						
1.0 LCD Crack/Broken  NOTE: X: Length Y: Width Z: Height L: Length of ITO,	(1) The edge of LCD broken	 <table border="1" data-bbox="849 678 1334 824"> <thead> <tr> <th>X</th> <th>Y</th> <th>Z</th> </tr> </thead> <tbody> <tr> <td>≤3.0mm</td> <td>&lt;Inner border line of the seal</td> <td>≤T</td> </tr> </tbody> </table>	X	Y	Z	≤3.0mm	<Inner border line of the seal	≤T
X	Y	Z						
≤3.0mm	<Inner border line of the seal	≤T						
T: Height of LCD	(2) LCD corner broken	 <table border="1" data-bbox="901 1272 1276 1361"> <thead> <tr> <th>X</th> <th>Y</th> <th>Z</th> </tr> </thead> <tbody> <tr> <td>≤3.0mm</td> <td>≤L</td> <td>≤T</td> </tr> </tbody> </table>	X	Y	Z	≤3.0mm	≤L	≤T
X	Y	Z						
≤3.0mm	≤L	≤T						
	(3) LCD crack	 <p style="text-align: center;">Crack Not allowed</p>						

<p>Spot defect</p>  <p>X</p> <p><math>\Phi = (X+Y)/2</math></p>	① light dot (LCD/TP/Polarizer black/white spot , light dot, pinhole, dent, stain)				
	Zone		Acceptable Qty		
	Size (mm)	A	B	C	
	$\Phi \leq 0.10$	Ignore			Ignore
$0.10 < \Phi \leq 0.15$	3( distance $\geq 10\text{mm}$ )				
$0.15 < \Phi \leq 0.2$	1				
$0.2 < \Phi$	0				
② Dim spot (LCD/TP/Polarizer dim dot, light leakage, dark spot)					
Zone		Acceptable Qty			
Size (mm)	A	B	C		
$\Phi \leq 0.1$	Ignore			Ignore	
$0.1 < \Phi \leq 0.2$	2( distance $\geq 10\text{mm}$ )				
$0.2 < \Phi \leq 0.3$	1				
$\Phi > 0.3$	0				
③ Polarizer accidented spot					
Zone		Acceptable Qty			
Size (mm)	A	B	C		
$\Phi \leq 0.2$	Ignore			Ignore	
$0.2 < \Phi \leq 0.5$	2( distance $\geq 10\text{mm}$ )				
$\Phi > 0.5$	0				
<p>Line defect (LCD/TP /Polarizer black/white line, scratch, stain)</p>	Width(mm)	Length(mm)	Acceptable Qty		
			A	B	C
	$\Phi \leq 0.03$	Ignore	Ignore		Ignore
	$0.03 < W \leq 0.05$	$L \leq 3.0$	$N \leq 2$		
	$0.05 < W \leq 0.08$	$L \leq 2.0$	$N \leq 2$		
$0.08 < W$	Define as spot defect				

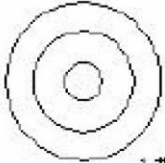
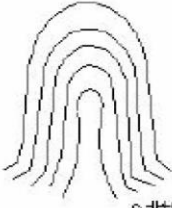
Polarizer Bubble	<table border="1"> <thead> <tr> <th data-bbox="379 286 603 338">Zone</th> <th colspan="3" data-bbox="603 286 1082 338">Acceptable Qty</th> </tr> <tr> <th data-bbox="379 338 603 389">Size (mm)</th> <th data-bbox="603 338 751 389">A</th> <th data-bbox="751 338 906 389">B</th> <th data-bbox="906 338 1082 389">C</th> </tr> </thead> <tbody> <tr> <td data-bbox="379 389 603 427"><math>\Phi \leq 0.2</math></td> <td colspan="2" data-bbox="603 389 906 427">Ignore</td> <td data-bbox="906 389 1082 539" rowspan="4">Ignore</td> </tr> <tr> <td data-bbox="379 427 603 465"><math>0.2 &lt; \Phi \leq 0.4</math></td> <td colspan="2" data-bbox="603 427 906 465">2 (distance <math>\geq 10\text{mm}</math>)</td> </tr> <tr> <td data-bbox="379 465 603 504"><math>0.4 &lt; \Phi \leq 0.6</math></td> <td colspan="2" data-bbox="603 465 906 504">1</td> </tr> <tr> <td data-bbox="379 504 603 539"><math>0.6 &lt; \Phi</math></td> <td colspan="2" data-bbox="603 504 906 539">0</td> </tr> </tbody> </table>			Zone	Acceptable Qty			Size (mm)	A	B	C	$\Phi \leq 0.2$	Ignore		Ignore	$0.2 < \Phi \leq 0.4$	2 (distance $\geq 10\text{mm}$ )		$0.4 < \Phi \leq 0.6$	1		$0.6 < \Phi$	0	
Zone	Acceptable Qty																							
Size (mm)	A	B	C																					
$\Phi \leq 0.2$	Ignore		Ignore																					
$0.2 < \Phi \leq 0.4$	2 (distance $\geq 10\text{mm}$ )																							
$0.4 < \Phi \leq 0.6$	1																							
$0.6 < \Phi$	0																							
SMT	According to IPC-A-610C class II standard . Function defect and missing part are major defect ,the others are minor defect.																							
	TP bubble/ accidented spot	<table border="1"> <thead> <tr> <th data-bbox="539 1055 735 1106">Size <math>\Phi</math>(mm)</th> <th colspan="3" data-bbox="735 1055 1161 1106">Acceptable Qty</th> </tr> <tr> <th data-bbox="539 1106 735 1158"></th> <th data-bbox="735 1106 879 1158">A</th> <th data-bbox="879 1106 1023 1158">B</th> <th data-bbox="1023 1106 1161 1158">C</th> </tr> </thead> <tbody> <tr> <td data-bbox="539 1158 735 1196"><math>\Phi \leq 0.1</math></td> <td colspan="2" data-bbox="735 1158 1023 1196">Ignore</td> <td data-bbox="1023 1158 1161 1279" rowspan="4">Ignore</td> </tr> <tr> <td data-bbox="539 1196 735 1234"><math>0.1 &lt; \Phi \leq 0.2</math></td> <td colspan="2" data-bbox="735 1196 1023 1234">2 (distance <math>\geq 10\text{mm}</math>)</td> </tr> <tr> <td data-bbox="539 1234 735 1272"><math>0.2 &lt; \Phi \leq 0.3</math></td> <td colspan="2" data-bbox="735 1234 1023 1272">1</td> </tr> <tr> <td data-bbox="539 1272 735 1310"><math>0.3 &lt; \Phi</math></td> <td colspan="2" data-bbox="735 1272 1023 1310">0</td> </tr> </tbody> </table>		Size $\Phi$ (mm)	Acceptable Qty				A	B	C	$\Phi \leq 0.1$	Ignore		Ignore	$0.1 < \Phi \leq 0.2$	2 (distance $\geq 10\text{mm}$ )		$0.2 < \Phi \leq 0.3$	1		$0.3 < \Phi$	0	
Size $\Phi$ (mm)	Acceptable Qty																							
	A	B	C																					
$\Phi \leq 0.1$	Ignore		Ignore																					
$0.1 < \Phi \leq 0.2$	2 (distance $\geq 10\text{mm}$ )																							
$0.2 < \Phi \leq 0.3$	1																							
$0.3 < \Phi$	0																							
	Assembly deflection	beyond the edge of backlight $\leq 0.15\text{mm}$																						

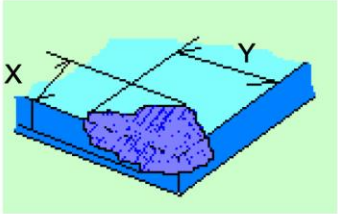
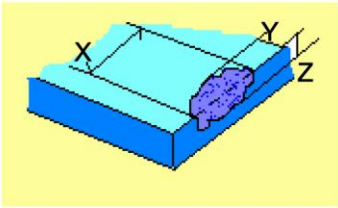
TP Related	Newton Ring	<p>Newton Ring area &gt; 1/3 TP area NG</p> <p>Newton Ring area ≤ 1/3 TP area OK</p>	 1 规律性   2 非规律性   似牛顿环						
	TP corner broken	<table border="1"> <tr> <td>X</td> <td>Y</td> <td>Z</td> </tr> <tr> <td>X ≤ 3.0mm</td> <td>Y ≤ 3.0mm</td> <td>Z &lt; LCD thickness</td> </tr> </table> <p>* Circuitry broken is not allowed.</p>	X	Y	Z	X ≤ 3.0mm	Y ≤ 3.0mm	Z < LCD thickness	
	X	Y	Z						
X ≤ 3.0mm	Y ≤ 3.0mm	Z < LCD thickness							
TP edge broken	<table border="1"> <tr> <td>X</td> <td>Y</td> <td>Z</td> </tr> <tr> <td>X ≤ 6.0mm</td> <td>Y ≤ 2.0mm</td> <td>Z &lt; LCD thickness</td> </tr> </table> <p>* Circuitry broken is not allowed.</p>	X	Y	Z	X ≤ 6.0mm	Y ≤ 2.0mm	Z < LCD thickness		
X	Y	Z							
X ≤ 6.0mm	Y ≤ 2.0mm	Z < LCD thickness							

Number	Items	Criteria (mm)
1	No display	Not allowed
2	Missing segment	Not allowed
3	Short	Not allowed
4	Backlight no lighting	Not allowed
5	TP no function	Not allowed

## **6.2 DEALING WITH CUSTOMER COMPLAINTS**

---

### **6.2.1 Non-conforming analysis**

Purchaser should supply Densitron with detailed data of non-conforming sample. After accepting it, Densitron should complete the analysis in two weeks from receiving the sample.

If the analysis cannot be completed on time, Densitron must inform the purchaser.

### **6.2.2 Handling of non-conforming displays**

If any non-conforming displays are found during customer acceptance inspection which Densitron is clearly responsible for, return them to Densitron.

Both Densitron and customer should analyse the reason and discuss the handling of non-conforming displays when the reason is not clear.

Equally, both sides should discuss and come to agreement for issues pertaining to modification of Densitron quality assurance standard.

## 7 RELIABILITY SPECIFICATION

### 7.1 RELIABILITY TESTS

Test Item		Test Condition	
Durability Test	High Temperature Storage	Ta= 80°C	96h
	Low Temperature Storage	Ta=-30°C	96h
	Temperature Cycle Storage	-20°C ← → 70°C ON/OFF, 20 cycles. ON time over 10 seconds ,OFF time over 10 seconds	
	High Temperature Operation	Tp= 70°C	96h
	Low Temperature Operation	Tp= -20°C	96h
	High Temperature & Humidity Operation	Tp= 40°C RH= 90% 96h Non condensing	
	Thermal Shock Resistance	The sample should be allowed to stand the following 5 cycles of operation: TSTL for 30 minutes -> normal temperature for 5 minutes -> TSTH for 30 minutes -> normal temperature for 5 minutes, as one cycle, then taking it out and drying it at normal temperature, and allowing it stand for 24 hours	
	Box Drop Test	1 Corner 3 Edges 6 faces, 66 cm (Medium Box)	

Note: Ta=ambient temperature Tp= Panel temperature

Notes:

1. No dew condensation to be observed.
2. The function test shall be conducted after 4 hours storage at the normal temperature and humidity after removed from the test chamber.
3. No cosmetic or functional defects should be allowed.
4. Total current consumption should be less than twice the initial value.

## 8 HANDLING PRECAUTIONS

### **Safety**

If the LCD panel breaks, be careful not to get the liquid crystal fluid in your mouth or in your eyes. If the liquid crystal touches your skin or clothes, wash it off immediately using soap and plenty of water.

### **Mounting and Design**

Place a transparent plate (e.g. acrylic, polycarbonate or glass) on the display surface to protect the display from external pressure. Leave a small gap between the transparent plate and the display surface.

When assembling with a zebra connector, clean the surface of the pads with alcohol and keep the surrounding air very clean.

Design the system so that no input signal is given unless the power supply voltage is applied.

### **Caution during LCD cleaning**

Lightly wipe the display surface with a soft cloth soaked with Isopropyl alcohol, Ethyl alcohol or Trichlorotrifluoroethane.

Do not wipe the display surface with dry or hard materials that will damage the polariser surface. Do not use aromatic solvents (toluene and xylene), or ketonic solvents (ketone and acetone).

### **Caution against static charge**

As the display uses C-MOS LSI drivers, connect any unused input terminal to VDD or VSS. Do not input any signals before power is turned on. Also, ground your body, work/assembly table and assembly equipment to protect against static electricity.

### **Packaging**

Displays use LCD elements, and must be treated as such. Avoid strong shock and drop from a height. To prevent displays from degradation, do not operate or store them exposed directly to sunshine or high temperature/humidity.

### **Caution during operation**

It is indispensable to drive the display within the specified voltage limit since excessive voltage shortens its life. Direct current causes an electrochemical reaction with remarkable deterioration of the display quality. Give careful consideration to prevent direct current during ON/OFF timing and during operation. Response time is extremely delayed at temperatures lower than the operating temperature range while, at high temperatures, displays become dark. However, this phenomenon is reversible and does not mean a malfunction or a display that has been permanently damaged. If the display area is pushed on hard during operation, some graphics will be abnormally displayed but returns to a normal condition after turning off the display once. Even a small amount of condensation on the contact pads (terminals) can cause an electro-chemical reaction which causes missing rows and columns. Give careful attention to avoid condensation.

### **Storage**

Store the display in a dark place where the temperature is 25°C ± 10°C and the humidity below 50%RH. Store the display in a clean environment, free from dust, organic solvents and corrosive gases.

Do not crash, shake or jolt the display (including accessories).

Product No.	DET043WVNMCMIS-4A	REV. 1.0
-------------	-------------------	----------

Page	31 / 31
------	---------